

ACMD42 Class 7 Model Year 2024

Vanguard Truck Center of Charlotte
NA

Prepared By : Mark Hughel
704-597-4212
Mark.Hughel@vanguardtrucks.com

Prepared For : KAYLYN MITMAN
NORTH CAROLINA SHERIFF'S
ASSOCIATION

Monday, March 13, 2023 11:41:03 AM EST

03/13/2023

Chassis Specification

		Description	Front Weight	Rear Weight	
AUTOCAR TRUCKS					
S	0010004	MODEL SERIES	AC MEDIUM DUTY SERIES	0	0
S	003005	MODEL CONFIGURATIONS	4X2 TRUCKS	0	0
S	0040005	MODELS	ACMD42	7,937	3,780
S	5004001	CAB SHELL	SINGLE LEFT HAND DRIVE CAB MUX	0	0
X	100T98	CUSTOMER LAYOUT	NONE	0	0
S	100U002	CUSTOMER TYPE	PUBLIC/PRIVATE	0	0
SOLUTION					
S	D010120	FRONT GAWR	12000 LBS	0	0
S	D020210	REAR GAWR	21000 LBS	0	0
S	D100330	GVWR	33000 LBS	0	0
VEHICLE ADAPTATION					
O	114010	COUNTRY OF USE	UNITED STATES STD MARKET ADAPTATION	0	0
ENGINE					
S	1580001	ENGINE VOCATION	COMMERCIAL - DOMESTIC (DOT)	0	0
S	1014012	ENGINE ASSY	B 6.7, 200 HP / 2400 RPM / 520 FT-LB, CUMMINS	0	0
S	102200	ENGINE HORSEPOWER RATING	200 HORSE POWER	0	0
S	105003	ENGINE FLYWHEEL HOUSING	SAE NUMBER 3 HOUSING	0	0
S	1030001	ENGINE OIL CHECK & FILL	EXTERIOR CHECK AND VALVE COVER FILL	0	0
S	4460001	FUEL TYPE	ULTRA-LOW SULPHUR DIESEL FUEL REQUIRED	0	0
S	972A002	SPECIAL EMISSION CERTIFICATION LABELS	EPA CERTIFIED-NO LABEL REQUIRED (DIESEL)	0	0
ENGINE EQUIP					
S	4380015	FILTER-FUEL, CHASSIS MOUNTED	FLEETGUARD FS SERIES F / W SEPARATOR W / PROBE & DASH LIGHT	0	0
S	1700003	FILTER-FUEL, ENGINE MOUNTED	SPIN-ON, ENGINE MOUNTED	0	0
S	1750001	ENGINE OIL	STANDARD ENGINE OIL	0	0
S	2004000	RADIATOR	725 SQ. IN. ALUMINUM	0	0
S	2080003	FAN & DRIVE-ENGINE	FAN CLUTCH, VISCOUS	0	0

S	1290004	ENGINE ELECTRONICS	CUMMINS 500K COMMUNICATION	0	0
S	2090001	RADIATOR COOLANT	EXTENDED LIFE COOLANT	0	0
S	2200004	AIR CLEANER	13" ONE STAGE	0	0
S	2304000	MUFFLER SYSTEM	LH VERTICAL SMA	0	0
S	2314000	EXHAUST SHIELDS	LH VERTICAL SMA ALUMINUM	0	0
O	2324008	EXHAUST STACKS	11' STAINLESS STEEL VERTICAL W/DIFFUSER	0	0
S	2354000	EXHAUST PIPING	EXHAUST BLANKETS	0	0
S	2394010	UREA DELIVERY SYSTEM	RH FRAME MTD 6 GAL CAPACITY	0	0
S	700026	AIR COMPRESSOR	CUMMINS WABCO 18.7 CFM COMPRESSOR	0	0
S	8024000	ALTERNATOR	DELCO REMY 160 AMP, 28SI PAD MTD W/O REMOTE SENSE	0	0
S	8205002	STARTING MOTOR	DELCO REMY 12V 31MT	0	0
S	P010065	VEHICLE GOVERNED SPEED LIMIT	SPEED LIMIT 65MPH	0	0
S	P020001	ENGINE IDLE SHUT DOWN	ENGINE IDLE SHUT DOWN ENABLED (5 MINUTES)	0	0
S	P030001	CRUISE CONTROL PARAMETER	CRUISE CONTROL ENABLED	0	0
S	171013	FILTER-ENGINE OIL BY- PASS	CUMMINS ENGINE OIL FILTER	0	0
S	172007	FILTER-ENGINE OIL FULL FLOW	CUMMINS COMBINATION FULL FLOW/BYPASS	0	0
S	1830001	STARTING AID-GLOW PLUG	GRID HEATER	0	0
S	201001	FAN SHROUD	FAN SHROUD	0	0
S	204002	COOLANT HOSES	SILICONE HOSES WITH STEEL TUBING	0	0

TRANSMISSION

S	2700033	TRANSMISSION	ALLISON 2500-SERIES, 6- SPEED	0	0
S	2580007	VOCATION	SWEEPER/UTILITY VP365 (RDS 2500 SERIES)	0	0
S	2840005	TRANSMISSION CONTROLS	ARENS PUSH BUTTON CONTROLS	0	0
S	2864000	COOLER-TRANSMISSION OIL	RADIATOR INTEGRATED COOLER	0	0
S	290003	TRANSMISSION OIL FILL/CHECK	OIL FILL TUBE / DIPSTICK W/ LEVEL SENSOR	0	0
S	300015	DRIVESHAFT-MAIN	SPICER 1710HD HALF ROUND	0	0
S	PT10001	TRANS DIRECTION CHANGE SHIFT INHIBIT	SHIFT INHIBIT ENABLED	0	0

S	2550011	TORQUE CONVERTER	TORQUE CONVERTER TC-211	0	0
S	292004	TRANSMISSION LUBRICANT	TRANSYND SYNTHETIC AUTO TRANS FLUID	0	0

FRONT AXLE

S	3700012	FRONT AXLE	DANA 1202W STEER AXLE, 12000 LB CAPACITY	0	0
S	371005	FRONT SUSPENSION	5500 LB FLATLEAF 12,500 GROUND CAPACITY	0	0
S	373002	SHOCK ABSORBERS-FRONT	DOUBLE ACTING SINGLE - HEAVY DUTY	0	0
S	904011	HUBS-FRONT	STEEL HUB PILOTED,285MM BOLT CIRCLE	0	0
S	9210001	HUB CAPS - FRONT AXLE	CR ZYTEL HUBCAP	0	0
S	374001	FRONT AXLE LUBRICANT	STANDARD	0	0
S	3690006	FRONT AXLE POSITION	44.5 INCHES	0	0
S	3834000	STEERING GEAR	INTEGRAL POWER STEERING W/O ASSIST RAM TAS65	0	0
S	387003	POWER STEERING RESERVOIR	FOUR QUART REMOTE MOUNTED	0	0

REAR AXLE

S	3300017	REAR DRIVE AXLE-SINGLE & TANDEM	MERITOR RS24-160, SINGLE REDUCTION AXLE	0	0
X	331996	REAR DRIVE AXLE RATIO	MUST CHOOSE REAR DRIVE AXLE RATIO	0	0
S	3500016	REAR SUSPENSION	HTS 21,000 LBS	0	0
S	3560001	REAR DRIVE AXLE STOPS	REAR BUMPSTOPS REQUIRED	0	0
S	3590001	SHOCK ABSORBERS-REAR	2 SHOCK ABSORBERS	0	0
S	9130001	HUBS-REAR	IRON HUB, HP 10 STUD	0	0
S	9410001	WHEEL OIL SEALS-REAR	SCOTSEAL PLUS XL	0	0
S	339001	REAR AXLE LUBRICANT	STANDARD	0	0
S	358001	TORQUE RODS	LONGITUDINAL ONLY - RUBBER BUSHED	0	0
S	3400001	REAR AXLE BREATHER	STANDARD AXLE BREATHER	0	0

BRAKES

S	7410004	BRAKE CONTROL SYSTEM	ABS 4S/4M W/PLC	0	0
S	782014	BRAKE VALVE-PARKING CONTROL	ONE PUSH - PULL TYPE W/YELLOW DIA-TRUCK	0	0
S	7510004	BRAKES-FOUNDATION, FRONT AXLE	MERITOR 16.5X5 QP	12	12
S	753018	BRAKE CHAMBERS-FRONT AXLE	CAM-STANDARD	0	0
S	754009	BRAKE SLACK ADJUSTERS -FRONT AXLE	MERITOR AUTOMATIC	0	0
S	755001	DUST SHIELDS - FRT BRAKES	DUST SHIELDS - FRONT BRAKES	8	0

S	901001	BRAKE DRUM-FRONT	CAST IRON	0	0
S	7610003	BRAKES-FOUNDATION, REAR AXLE	ARVIN MERITOR 16.5X7 Q PLUS	0	0
S	763019	BRAKE CHAMBERS-REAR AXLE	CAM-STANDARD	0	0
S	764012	BRAKE SLACK ADJUSTERS -REAR AXLE	ARVIN MERITOR AUTOMATIC-SINGLE AXLE	0	0
S	765001	DUST SHIELDS - REAR BRAKES	DUST SHIELDS - REAR BRAKES	0	8
S	781011	BRAKE CHAMBERS- PARKING, TYPE/VENDOR	CAM TYPE M\G\M STOPGARD (2)	0	0
S	910001	BRAKE DRUM-REAR	CAST IRON	0	0
S	7204001	BRAKE VALVE & PEDAL	FIREWALL MTD LH BRAKE PEDAL FOR LHD	0	0

CHASSIS

S	402038	FRAME-REAR OVERHANG	38 INCHES	0	0
S	400164	WHEELBASE	164 INCHES	0	0
S	4030007	FRAME RAILS	10" X 3" X 3/8" 120KSI STRAIGHT RAIL SECTION - 2.13M RBM	0	0
S	406001	FRAME-REAR CUT-OFF	STRAIGHT	0	0
S	4090003	FRAME CROSSMEMBER- CENTER	7-PIECE STEEL CROSSMEMBERS	0	0
S	4150004	FRAME CROSSMEMBER- OVERHANG	7 PC STEEL CMBR ROS - IF REQUIRED	0	0
S	430500	FUEL TANK-LEFT	TEMP. FUEL TANK	-10	-15
S	436001	FUEL LINES	SAE J844 NYLON TUBING	0	0
S	4604000	BUMPER-FRONT	STANDARD DUTY BUMPER	0	0
S	4800003	TOWING DEVICE-FRONT	TWO TOW HOOKS INTERGRAL W/ FRNT XMEMBER	0	0
S	711001	AIR TANK-BRAKE	STEEL TANKS FOR SINGLE AXLE	0	0
S	711U06	AIR TANK MOUNTING	AS MANY TANKS IN RAIL AS POSSIBLE	0	0
S	7134000	AIR DRYER	WABCO 1200 PLUS AIR DRYER	0	0
S	713T002	AIR DRYER MOUNTING LOCATION	AIR DRYER MTD OUTSIDE RAIL, LH	0	0
S	715T400	AIR RESERVOIR DRAIN SYSTEM	PULL CORDS ALL TANKS	0	0
S	728001	AIR LINES-MAIN, CHASSIS	SAE J844 NYLON TUBING	0	0
S	783001	BRAKE MODULATION SYSTEM-PARKING	PARK BRAKE RELAY/INVERSION VALVE	0	0
S	8100002	BATTERY	2 BATTERIES, 12V, 1500CCA	0	0
S	8120011	BATTERY BOX	BATTERY BOX, 2 BATTERY CAPACITY	0	0

S	812T002	BATTERY BOX POSITION	BOX LOCATED LHS UNDER CAB	0	0
S	8924000	BACKUP ALARM	107DB FIXED OUTPUT BACKUP ALARM	0	0

CAB EXTERIOR

S	4510001	STEP-CAB ACCESS, CAB MOUNTED	DUAL SELF CLEANING CAB ENTRANCE STEPS	0	0
S	502001	CAB DOORS	STEEL	0	0
S	5100002	GLASS	WINDSHIELD - LAMINATED, ALL GLASS EXCEPT FRONT TINTED	0	0
S	6220013	MIRRORS-DUAL WEST COAST	MIRROR, BLACK, MOTORIZED/HTD POLYCARBONATE HOUSING W/SQUARE MOTORIZED/HTD CONVEX MIRROR	2	0
S	661001	CAB TILT MECHANISM-C.O.E.	HYDRAULIC TILT	0	0
S	661A400	SAFETY BAR	SAFETY BAR	0	0
S	6720001	GRILLE	AUTOCAR GRILLE BLACK	0	0

CAB INTERIOR

S	3800005	STEERING WHEEL	SINGLE DRIVE 16 INCH DIAMETER	0	0
S	3810004	STEERING COLUMN	ADJ. TILT AND TELESCOPIC STEERING COLUMN	0	0
S	5204002	SEAT-DRIVER	SEARS SEAT W/ AIR RIDE SUSP, W/ AIR CONTROLLED LUMBAR SUPPORT	0	0
O	5214002	SEAT-PASSENGER	SEARS SEAT W/ AIR RIDE SUSP, W/ AIR CONTROLLED LUMBAR SUPPORT	0	0
S	522003	SEAT BELTS-DRIVER	THREE POINT RETRACTABLE	0	0
S	523003	SEAT BELTS-PASSENGER	THREE POINT RETRACTABLE	0	0
S	5384000	CARPET & MAT	WEAR RESISTANT MAT WITH FOAM BACK W/HEAVY DUTY FLOOR MATS	0	0
S	5404002	CAB PANELS-INTERIOR TRIM	ACMD STANDARD INTERIOR TRIM W/ REDUCED LOWER IP SKIRT	0	0
S	547001	INSULATION-CAB THERMAL	THERMAL INSULATION KIT FOR CAB	0	0
S	5949997	CIGAR LIGHTER	COMPONENTS SUPPLIED BY CAB SUPPLIER	0	0
S	8644000	LAMPS-CAB INTERIOR	LED DOME LAMPS	0	0

GAUGES & INSTRUMENTATION

S	1434001	TRUCK ELECTRICAL CONTROL MODULE	STANDARD MULTIPLEX MODULE	0	0
---	---------	--	---------------------------	---	---

S	225009	AIR INTAKE RESTRICTION INDICATOR	GRADUATED, AIR CLEANER MOUNTED	0	0
S	288009	MONITORING - TRANSMISSION OIL TEMP	TRANS TEMP WARNING LIGHT & BUZZER	0	0
S	1472001	VEHICLE MONITORING SYSTEM	AUTOCAR ADVANCED TELEMATICS-FULL INSTALLATION	0	0

LIGHTING

O	8360003	LAMPS-HEAD	LED HEADLAMPS	0	0
S	8390002	STOP-TAIL HARNESS	OMIT TAIL LAMPS, BB CONN @ EOF	0	0
S	8410005	LAMPS-TURN SIGNAL - FRONT	AMBER FRONT TURN SIGNALS	0	0
S	8510002	LAMPS-MARKER	AMBER LED ROOF MARKERS	0	0

RADIO/MISC

S	5090001	KEY & LOCK SETS-IGN/DOORS	2 ADDITIONAL KEYS PER TRUCK (4 TOTAL)	0	0
S	5900005	RADIO	RADIO PREP IN OVERHEAD CONSOLE	0	0

FRONT TIRES / WHEELS

S	9400001	WHEEL OIL SEALS-FRONT	SCOTSEAL PLUS XL	0	0
S	9050014	WHEELS-DISC FRONT	22.5x8.25" STEEL HP, 6.18" INSET, 5HH	0	0
S	907002	FRONT TIRE QUANTITY	2 FRONT TIRES	0	0
S	930068	TIRE SIZE & LOAD RANGE - FRONT	11R22.5G	0	0
S	9314009	TIRE MANUFACTURER & TREAD - FRONT	DOUBLE COIN RR680	0	0

REAR TIRES / WHEELS

S	908004	REAR TIRE QUANTITY	4 REAR TIRES	0	0
S	9140014	WHEELS-DISC REAR	22.5X8.25" STEEL, HP, 5HH	0	0
S	933068	TIRE SIZE & LOAD RANGE - REAR	11R22.5G	0	0
S	9344009	TIRE MANUFACTURER & TREAD - REAR	DOUBLE COIN RR680	0	0

PAINT

S	950001	CAB PAINT SCHEME	SINGLE COLOR PAINT	0	0
S	9550001	CAB PAINT TYPE	STANDARD WHITE	0	0
S	9804018	CAB COLOR-FIRST	APPROVED--913218EX-- STANDARD WHITE 913218EX	0	0
S	9861U1	CHASSIS COLOR	BLACK P3036	0	0
X	9870002	BUMPER COLOR	PAINT SAME AS CAB, STEEL	0	0
S	988401	DISC WHEEL OR RIM COLOR	STEEL, E-COAT WHITE / ALUM-UNPAINTED	0	0
S	989949	AXLE WHEEL END COLOR	SAME AS CHASSIS	0	0

ADDITIONAL OPTIONS

S	899002	CHASSIS WARRANTY	STANDARD WARRANTY	0	0
S	899A007	TRANSMISSION WARRANTY	ALLISON 3YR WARRANTY	0	0
S	899B001	ENGINE WARRANTY	CUMMINS STANDARD WARRANTY	0	0
S	899S98	EPA SURCHARGE	NO EPA SURCHARGE	0	0
S	978000	FLOOR PLAN	NO FLOORING PLAN	0	0
S	969V002	ADDITIONAL PRICE ADJUSTMENT	TEMPORARY INFLATION ADJUSTMENT	0	0

OTHERS

S	740004	CERTIFICATION COMPLIANCE	US SALE-US COMMERCE-34 MPH AND UP	0	0
S	9722023	CERTIFICATION-EMISSIONS	MY 2023 ENGINE, COMPLIES WITH 2021 US EMISSIONS	0	0
S	974004	CERTIFICATION-EXTERIOR NOISE	COMPLIES W/U.S. & CANADA 80D\B\A AT 50FT	0	0

SUB TOTALS

BASE WEIGHT	7,937	3,780
FACTORY OPTION WEIGHT	12	5
DISTRIBUTOR OPTION WEIGHT	0	0

TOTALS

TOTAL WEIGHT (LB)	7,949	3,785	11,734
-------------------	-------	-------	--------

03/13/2023

Dimensions

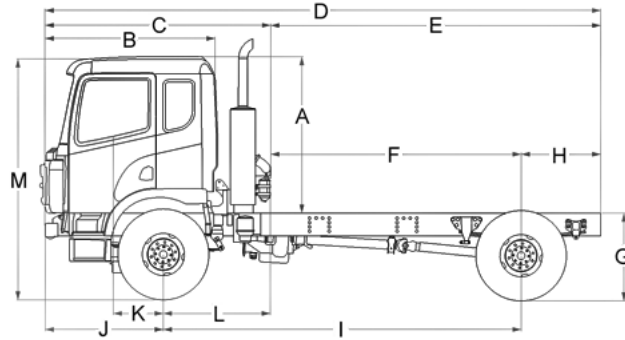

	Dimension(ft)	Description
A	71.85	CAB HEIGHT
B	80.96	BUMPER TO BACK OF CAB
C	104.11	EFFECTIVE BUMPER TO BACK OF CAB
D	258.11	OVERALL LENGTH
E	154.00	EFFECTIVE CAB TO END OF FRAME
F	116.00	EFFECTIVE CAB TO REAR AXLE
G	40.70	UNLADEN FRAME HEIGHT
H	38.00	OVERHANG
I	164.00	WHEELBASE
J	56.11	BUMPER TO FRONT AXLE
K	-18.00	DRIVER CENTER OF GRAVITY
L	48.00	EFFECTIVE FRONT AXLE TO BACK
M	112.55	OVERALL HEIGHT
N	0.00	FRONT FRAME EXTENSION

SPECIFICATION SUMMARY

Model	ACMD42 Class 7
Engine	B 6.7, 200 HP / 2400 RPM / 520 FT-LB, CUMMINS
Transmission	ALLISON 2500-SERIES, 6-SPEED
Rear Axle	MERITOR RS24-160, SINGLE REDUCTION AXLE
Rear Axle Ratio	MUST CHOOSE REAR DRIVE AXLE RATIO
Rear Tire	11R22.5G

03/13/2023

Turning Radius

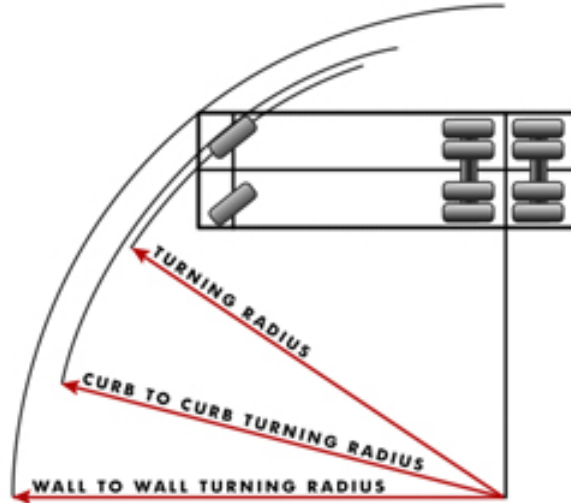

	Dimension(ft)	Description
A	22.82	TURNING RADIUS
B	47.48	CURB TO CURB TURNING DIAMETER
C	51.54	WALL TO WALL TURNING DIAMETER

SPECIFICATION SUMMARY

Model	
Engine	B 6.7, 200 HP / 2400 RPM / 520 FT-LB, CUMMINS
Transmission	ALLISON 2500-SERIES, 6-SPEED
Rear Axle	MERITOR RS24-160, SINGLE REDUCTION AXLE
Rear Axle Ratio	MUST CHOOSE REAR DRIVE AXLE RATIO
Rear Tire	11R22.5G

03/13/2023

Shift Chart

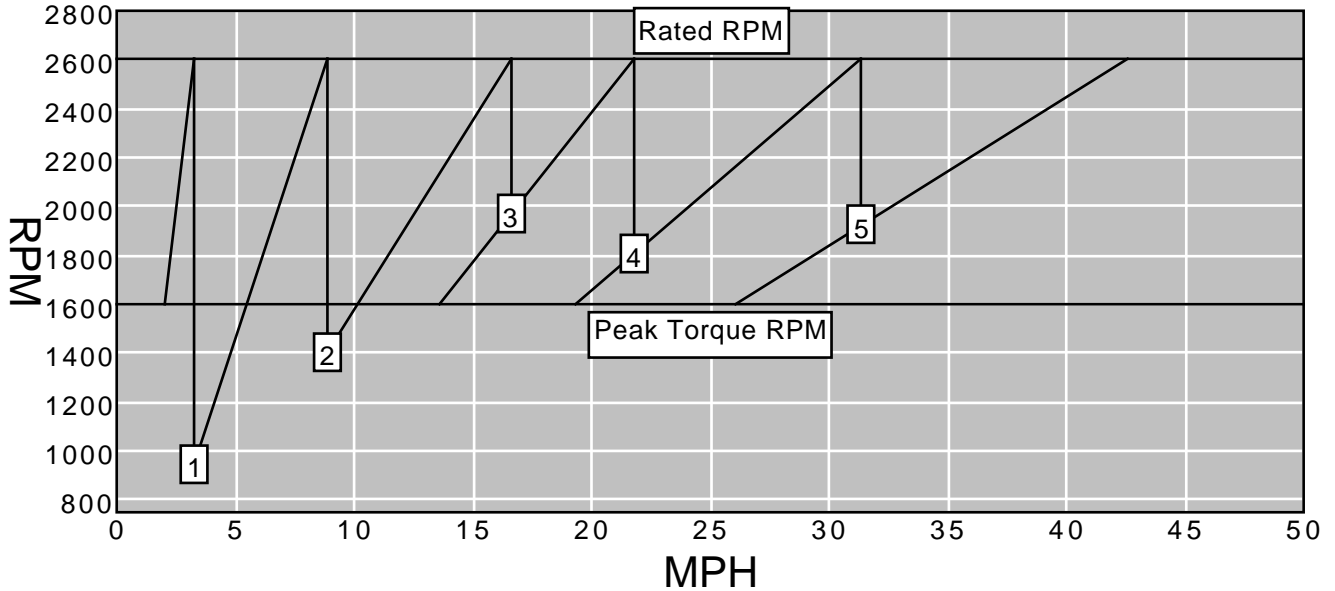

Gear	Trans. Ration	Rear Axle Ration	Overall Reduction	% Split	MPH	RPM After Shift
1C	9.61	9.96	95.7	0.0	3.3	0
1	3.51	9.96	35.0	173.6	8.9	950
2	1.90	9.96	18.9	85.2	16.6	1,403
3	1.44	9.96	14.3	31.8	21.8	1,973
4	1.00	9.96	10.0	43.9	31.4	1,806
5	0.74	9.96	7.3	35.7	42.6	1,916

SPECIFICATION SUMMARY

Model	ACMD42 Class 7
Engine	B 6.7, 200 HP / 2400 RPM / 520 FT-LB, CUMMINS
Rated Power	200 HP @ 2600 RPM
Peak Torque	520 LB-FT @ 1600
Transmission	ALLISON 2500-SERIES, 6-SPEED
Rear Axle	MERITOR RS24-160, SINGLE REDUCTION AXLE
Rear Axle Ratio	MUST CHOOSE REAR DRIVE AXLE RATIO
Rear Tire	11R22.5G
Tire Revolution	499

03/13/2023

Operating Range

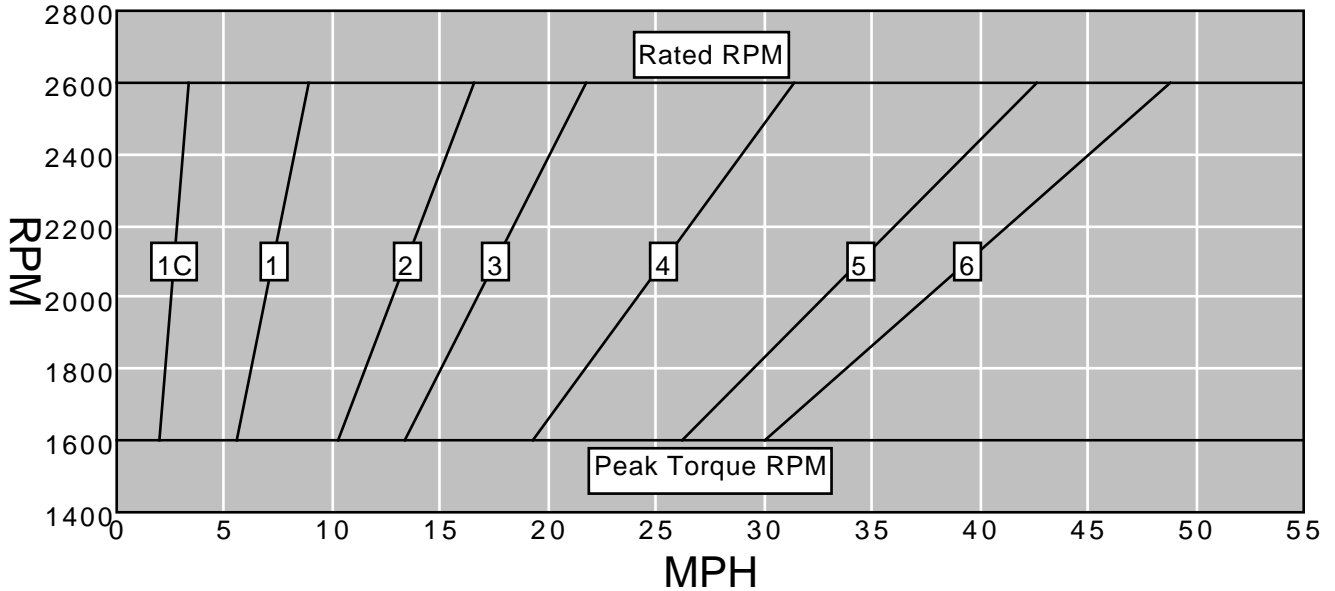

Gear	Trans. Ratio	Rear Axle Ratio	Minimum MPH	Maximum MPH
1C	9.61	9.96	2.0	3.3
1	3.51	9.96	5.5	8.9
2	1.90	9.96	10.2	16.6
3	1.44	9.96	13.4	21.8
4	1.00	9.96	19.3	31.4
5	0.74	9.96	26.2	42.6
6	0.64	9.96	30.0	48.8

SPECIFICATION SUMMARY

Model	ACMD42 Class 7
Engine	B 6.7, 200 HP / 2400 RPM / 520 FT-LB, CUMMINS
Rated Power	200 HP @ 2600 RPM
Peak Torque	520 LB-FT @ 1600
Transmission	ALLISON 2500-SERIES, 6-SPEED
Rear Axle	MERITOR RS24-160, SINGLE REDUCTION AXLE
Rear Axle Ratio	MUST CHOOSE REAR DRIVE AXLE RATIO
Rear Tire	11R22.5G
Tire Revolution	499

03/13/2023

Gradeability

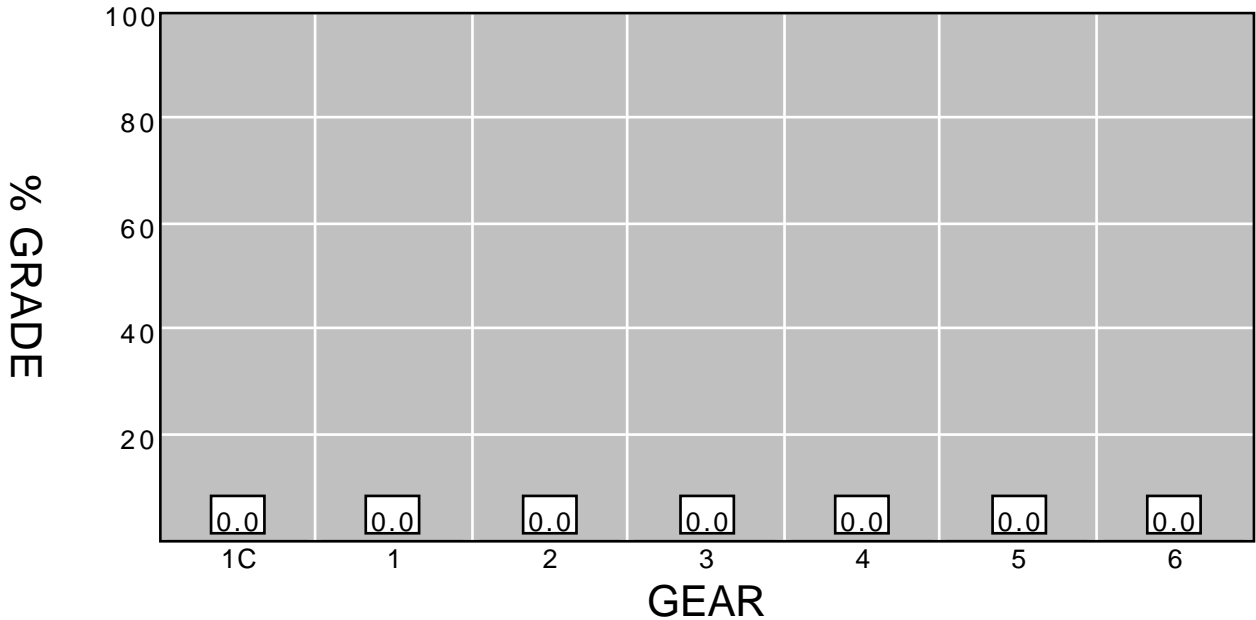

Gear	Trans. Ratio	Rear Axle Ratio	Overall Reduction	Peak Torque	Wheel HP	MPH	Maximum Grade%
1C	9.61	9.96	95.7	520.0	178.5	2.0	0.0
1	3.51	9.96	35.0	520.0	178.5	5.5	0.0
2	1.90	9.96	18.9	520.0	178.5	10.2	0.0
3	1.44	9.96	14.3	520.0	178.5	13.4	0.0
4	1.00	9.96	10.0	520.0	178.5	19.3	0.0
5	0.74	9.96	7.3	520.0	178.5	26.2	0.0
6	0.64	9.96	6.4	520.0	178.5	30.0	0.0

SPECIFICATION SUMMARY

Model	ACMD42 Class 7
Engine	B 6.7, 200 HP / 2400 RPM / 520 FT-LB, CUMMINS
Peak Torque	520 LB-FT @ 1600
Transmission	ALLISON 2500-SERIES, 6-SPEED
Rear Axle	MERITOR RS24-160, SINGLE REDUCTION AXLE
Rear Axle Ratio	MUST CHOOSE REAR DRIVE AXLE RATIO
Rear Tire	11R22.5G
Tire Revolution	499
GVW/GCV	0
Surface	Concrete

03/13/2023

Startability

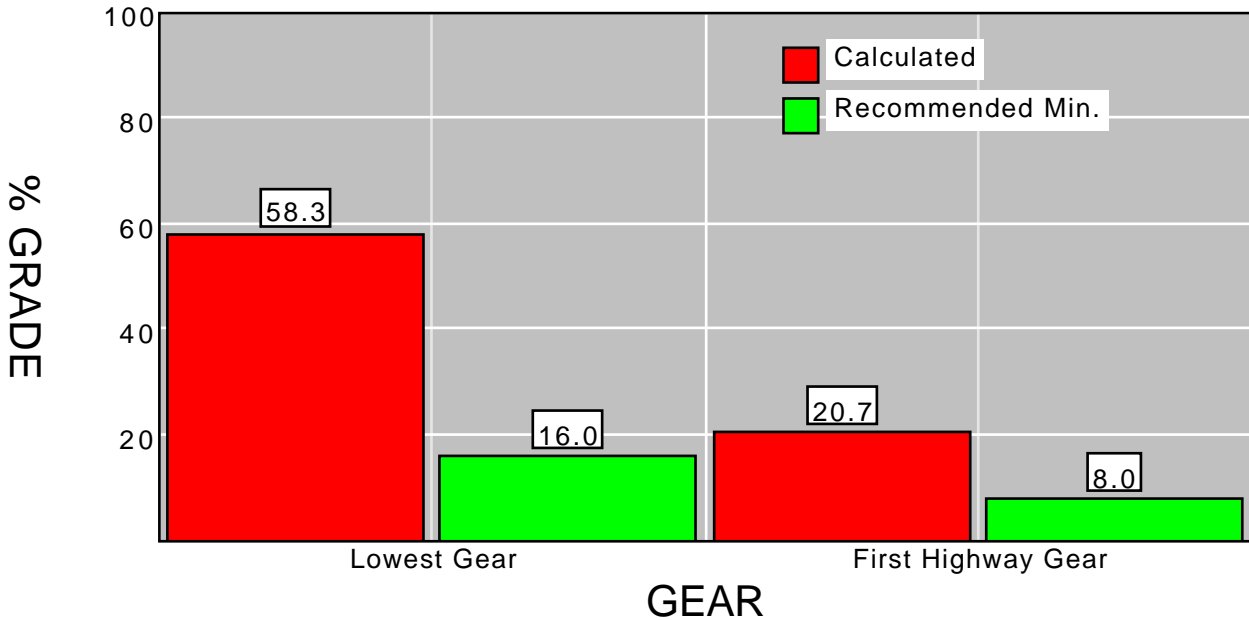

Gear	Application	Recommended Minimum Grade %	Calculated Grade %
Lowest Gear	City	12.0	n/a
	On Highway	16.0	58.3
	On-Off Highway	18.0	n/a
	Off Highway	20.0	n/a
			0.0
First Highway Gear	All Applications	8.0	20.7

"SPECIFICATION SUMMARY"

Model	ACMD42 Class 7
Engine	B 6.7, 200 HP / 2400 RPM / 520 FT-LB, CUMMINS
Clutch Torque	400 LB-FT 700 RPM
Transmission	ALLISON 2500-SERIES, 6-SPEED
Rear Axle	MERITOR RS24-160, SINGLE REDUCTION AXLE
Rear Axle Ratio	MUST CHOOSE REAR DRIVE AXLE RATIO
Rear Tire	11R22.5G
Tire Radius	19.8
GVW/GCV	0
Surface	Concrete
Terrain	On Highway

03/13/2023

Top Speed

Speed At Maximum RPM

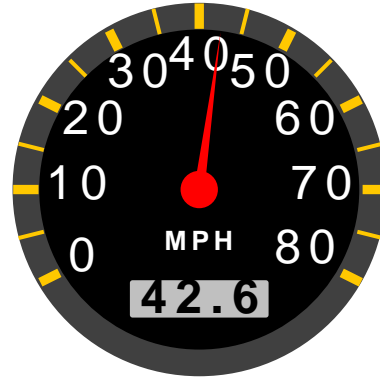

RPM At 60MPH

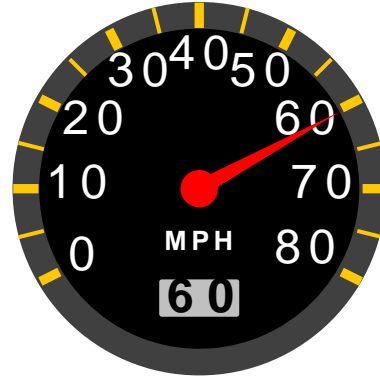

	MPH	RPM
Top Speed	42.6	2,600
Cruise Speed	60.0	3,662
Minimum Of Engine Range	19.7	1,200
Maximum Of Engine Range	42.6	2,600
Minimum Of Economy Range	19.7	1,200
Maximum Of Economy Range	42.6	2,600

SPECIFICATION SUMMARY

Model	ACMD42 Class 7
Engine	B 6.7, 200 HP / 2400 RPM / 520 FT-LB, CUMMINS
Transmission	ALLISON 2500-SERIES, 6-SPEED
Rear Axle	MERITOR RS24-160, SINGLE REDUCTION AXLE
Rear Axle Ratio	MUST CHOOSE REAR DRIVE AXLE RATIO
Rear Tire	11R22.5G
Tire Revolution	499

03/13/2023

Chassis Standards

Code Description

FRAME EQUIPMENT

408001	STEEL ENGINE CROSSMEMBER
4160001	OVERSLUNG X-MEMBER INTEGRAL W/ENG MOUNTS
4800003	TWO TOW HOOKS INTEGRAL W/FRONT XMEMBER

ENGINE EQUIPMENT

2120003	STANDARD SURGE TANK W/ SIGHT GLASS
6020002	SILICONE HEATER HOSES
602C01	CONSTANT TORQUE HOSE CLAMPS
602S001	NO HEATER SHUT-OFF TAP
724001	CAB AIRLINES - SAE J844 NYLON TUBING
729002	AIR LINES CHASSIS PARK BRAKE
701001	STANDARD AIR COMPRESSOR GOVERNER
702002	TEFLON HOSE DISCHARGE LINES
233004	TURNED OUT EXHAUST STACK
1030001	ENGINE DIPSTICK ACCESIBLE W/O TILTING CAB

HVAC EQUIPMENT

6000002	AIR CONDITIONING W/ HEATER / DEFROSTER / CLIMATE CONTROL
060001	AIR COND INTEGRAL WITH HEATER/DEFROSTER
608002	R134A REFRIGERANT
611003	STANDARD AC COMPRESSOR
612001	STANDARD AC CONDENSER
615004	R134A HOSES WITH CRIMPED FITTINGS

CAB INTERIOR

512010	DUAL POWER WINDOWS
533013	CAB DOOR PANELS BOTH SIDES
541005	COLOR KEYED TO TRIM COLOR
542016	INTERIOR SUNVISOR LEFT AND RIGHT HAND PROVIDED
5530001	STANDARD INTERIOR TRIM DOOR SILLS
5680003	OVERHEAD CONSOLE W/DRIVER AND PASSENGER SIDE STORAGE BINS
570009	COLOR KEYED INSTRUMENT PANEL
594001	DASH MOUNTED CIGAR LIGHTER

CAB / RADIO PREP PACKAGE

5900005	RADIO PREP IN OVERHEAD CONSOLE
5960052	DUAL CONE SPEAKERS

Note: ACMD Chassis & Cab Standards are subject to change without notice.

Code Description

CAB INSTRUMENTATION

704002	AUDIBLE AND VISUAL LOW AIR WARNING DEVICE
132034	AUDIBLE/VISUAL ALARM/Low Oil PSI, High Coolant Temp, Low Coolant Level
0570006	ACMD GAUGE PACKAGE #1 AIR BRAKE SYSTEM
5770001	GAUGE, ELECTRONIC SPEEDOMETER WITH ODOMETER
1360001	GAUGE, ELECTRONIC TACHOMETER WITH HOURMETER
1380001	GAUGE, ELECTRONIC ENGINE OIL PRESSURE
1400001	GAUGE, ELECTRONIC ENGINE COOLANT TEMP
4390001	GAUGE, ELECTRONIC FUEL LEVEL GAUGE
7030001	GAUGE, DUAL AIR SYSTEM PRESSURE GAUGE
8040001	GAUGE, ELECTRONIC VOLTMETER

CAB EQUIPMENT

133003	WILLIAMS ACCELERATOR PEDALS
6280002	ELECTRIC INTERMITTENT WIPERS
629003	STANDARD WINDSHIELD WASHER
631001	SINGLE ELECTRIC HORN
782L01	PARK BRAKE INDICATOR LIGHT
801002	NEGATIVE GROUND 12VOLT
8040001	ELECTRONIC VOLTMETER
811002	STANDARD BATTERY CABLES
8220004	IGNITION SWITCH WITH STARTER BUTTON
8360002	HEADLIGHTS - RECTANGULAR SEALED BEAM
842001	REAR TURN SIGNAL LAMPS - WIRED INTO TAIL LAMPS
8440003	SELF-CANCELING TURN SIGNALS
8640001	DOMELAMPS LH AND RH SIDE

CAB EXTERIOR EQUIPMENT

6190003	STANDARD RETRACTABLE MIRROR ARMS
4604001	AUTOMOTIVE BUMPER
624012	STANDARD GRAB HANDLES - MEETS FMCSR 399 REQUIREMENTS
624U001	ENTRY GRAB HANDLES LH & RH MTD TO INSIDE OF A-PILLAR ON IP
6340002	FRONT GRAB HANDLES
6340002	LH & RH INTEGRAL WASHER NOZZLES
626001	AMBER REFLECTORS
6620001	HYDRAULIC RELEASE CAB LATCHES
675001	BUG SCREEN MOUNTED BEHIND GRILLE

CHASSIS PAINT

956025	CHASSIS PAINT - 2 PART POLYURETHANE ENAMEL (SEMI-GLOSS BLACK)
--------	---

Note: ACMD Chassis & Cab Standards are subject to change without notice.