

**SUGGESTED PRICE LIST  
(F.O.B. PERRY, OKLAHOMA)**

**Effective April 1, 2023**

PART NO.	DESCRIPTION	MSRP (USD)
----------	-------------	------------

**JT28 HRC PACKAGE #1**

- Cummins QSB4.5, turbocharged and charge air cooled, liquid cooled diesel engine (130 hp @ 2500 rpm) EPA Tier 4 compliant

Includes: Single Joystick, Advanced Wireless Ground Drive Control, HD Anchor System with Dirt Anchors

**JT28 HRC BASE UNIT**

- Cummins QSB4.5, turbocharged and charge air cooled, liquid cooled diesel engine (130 hp @ 2500 rpm) EPA Tier 4 compliant

Includes: Single Joystick, HD Anchor System with Dirt Anchors, Tethered Ground Drive Control

**JT28 LRC BASE UNIT**

- Cummins QSB4.5, turbocharged and charge air cooled, liquid cooled diesel engine (130 hp @ 2500 rpm) EPA Tier 3 compliant

Includes: Single Joystick, HD Anchor System with Dirt Anchors, Tethered Ground Drive Control

**OPTIONAL UPGRADES**

- Dual Controls
- Advanced Wireless
- Heavy Duty Rock
- HydraTong
- Cab Option

**ORANGE INTEL™ OPTIONS**

190-2693	CLM3000 GPS KIT	(2yrs included)
190-2695	CLM3000 TELEMATICS KIT	(2yrs included)
240-7222	Hosting Plan - CLM 3657 TM 1yr (20MB/mo)	(Sold in One Year Increments)
240-1359	Hosting Plan - CLM 3657 GPS 1yr (5MB/mo)	(Sold in One Year Increments)

**ACCESSORIES**

100-074	STRIKE MAT KIT
100-794	GROUNDING KIT
190-1861	HEATED HOSE KIT
149-973	SPLIT ROD WIPER 1.75" ID
190-1808	SHORT PIPE BOX KIT
190-2138	JT25/JT28/JT30/AT30 T4F UPTIME KIT
190-2139	JT25/JT28/JT30/AT30 LRC UPTIME KIT

**DRILL PIPE**

355-1244	DW FORGED HD 2.38 X 2.75 2.11-4 3M	each
355-1111	POWER PIPE HD FM 2.38 X 2.75 2.11-4 3M	each
355-1094	POWER PIPE HD UL 2.38 X 2.75 2.11-4 3M	each
355-1350	HDX DRILL PIPE 2.38 X 2.63 #600 3M	each

**SUGGESTED PRICE LIST  
(F.O.B. PERRY, OKLAHOMA)**

**Effective April 1, 2023**

PART NO.	DESCRIPTION	MSRP (USD)
----------	-------------	------------

**Marksman™+ Guidance System**

The new Marksman™ system is a guidance system for tracking horizontal directional bores. The system is comprised of a tracker, drill rig display and beacon. The Marksman™ system provides many new and enhanced features and offers a Marksman™+ tracker with 32 frequency options, the ability to use current display offerings (Commander™ 7, TD Recon and Integrated Displays with the use of the Recon CAN), and a new 17" beacon option, the M17+. The Marksman™ system will not be backwards compatible with the existing TK Recon series trackers or T-series beacons.

The Marksman™+ tracker detects the widest frequency range in the industry within a single beacon, with 32 frequencies ranging from 1.9 kHz to 46 kHz frequencies and utilizes an ISM telemetry radio to communicate to the rig display, the ISM radio frequency is country specific. See corresponding part numbers below. Each Marksman™+ tracker comes standard with two rechargeable Li-Ion batteries, charger and operators manual. Selectable options include, the choice between Hard case, EVA case, carry bag or nothing and between a swivel, small or no stand.

Separately, select a corresponding, country specific TD Recon display, Commander™ 7 display or Recon CAN Bridge (For Integrated Displays).

Marksman-Plus radios

**Marksman™ Parts & Accessories**

- 220-2846 ADAPTER, 21700 RECHARGEABLE BEACON BAT
- 222-6213 3220 HARD CASE, TRACKER COMBO
- 222-6212 EVA CASE, TRACKER COMBO
- 222-6205 SMART LI-ION RECHARGE TRACKER BAT, MARKS
- 220-2847 MARKSMAN SWIVEL BASE MOUNT
- 222-6215 Tracker Base Mount, Marksman
- 222-6221 CHARGER, 21700 RECHARGEABLE BEACON BAT
- 222-2661 COMMANDER 7 FIELD PROGRAMMING HARNESS

**M17+ Beacon**

The M17+ beacon comes with 32 discreet frequencies ranging from 1.9 kHz to 46 kHz, and two power levels. The M17+ works with the Marksman+ tracker and is not compatible with TK or TK Recon trackers. The M17+ comes standard as a grade pitch beacon, and includes the flat-top/half-moon isolators for side-load housings. An optional 220-1090 hard case, battery adapter and other isolators are available in the selectable parts section. Length is 17.8 in (452 mm), diameter is 1.5 in (38 mm).

- 102-2572 M17-PLUS BEACON

**SUGGESTED PRICE LIST  
(F.O.B. PERRY, OKLAHOMA)**

Effective April 1, 2023

---

PART NO.	DESCRIPTION	MSRP (USD)
----------	-------------	------------

---

**Marksman™ Guidance System**

The Marksman tracker detects 6 frequencies 12kHz, 13kHz, 28kHz, 29kHz, 37kHz, 38kHz and utilizes an ISM telemetry radio to communicate to the rig display; the rig display is country specific. Each Marksman tracker comes standard with two rechargeable Li-ion batteries, charger and operator's manual. Selectable options include: the choice between a Hard case, Eva case, carry bag or no carry bag, as well as the choice between a swivel stand, small stand or no stand.

Separately, select a corresponding, country specific TD Recon display, Commander™ 7 display or Recon CAN Bridge (For Integrated Displays).

Marksman radios

**M17 Beacon**

The M17 has 6 discreet frequencies 12kHz, 13kHz, 28kHz, 29kHz, 37kHz, 38kHz with normal power. The M17 beacon works with the Marksman and Marksman+ tracker and is not compatible with TK or TK Recon trackers. The M17 comes standard as a grade pitch beacon, and includes the flat-top/half-moon isolators for side load housings. An optional hard case, battery adapter and other isolators are available in the selectable parts section. Length is 17.8 in (452 mm), diameter is 1.5 in (38 mm).

102-10013 M17 BEACON

**SUGGESTED PRICE LIST  
(F.O.B. PERRY, OKLAHOMA)**

**Effective April 1, 2023**

PART NO.	DESCRIPTION	MSRP (USD)
----------	-------------	------------

**Commander™ 7 Display**

The Commander™ 7 is used exclusively with all models of TK Recon tracker and supported beacons. The system leverages the planning capabilities of the Field Scout™ mobile through the built-in ScoutView™ application. The system provides projected depth information and offers both Classic and Advanced Drill-To guidance modes. The display utilizes an ISM radio to communicate to the tracker, radio frequency is country specific. See corresponding part numbers below. The display has internal data storage capabilities and works with TMS Plus and TSR software. The system includes all necessary cabling and antenna, display assembly, dash assembly hard case and operators manual.

Commander7A radios

**Commander™ 7 Parts and Accessories**

220-2814	CMDR 7 Competitive Mount Kit 23x30 24x40	
240-7210	ScoutView	
220-2633	COMMANDER 7 DEMONSTRATION KIT	
222-6714	HARNESS, COMMANDER 7, DEMO	
222-6720	8 PIN CONNECTOR PLUG, COMMANDER 7	
222-6721	PLUG SEAL, COMMANDER 7	
222-3219	LANYARD	
222-6978	CMDR 7 DISPLAY 48" EXTENSION CORD (web)	
222-6615	2.5" MOUNTING MAGNET, 3/8-16	
222-6617	COMMANDER 7 MAGNET COVER	
220-2770	Commander 7 Mag Mount Kit	
222-6707	CIRCULAR RAM MOUNT 1.5" WITH 3/8-16 STUD	
220-2645	COMMANDER 7 MOUNTING PLATE, JT5	
222-6729	JT 20 AND 30 DASH PLATE, COMMANDER 7	
222-6620	RAM, DISPLAY ARM, STANDARD	
222-6719	COMMANDER 7 CARRYING CASE	
222-6517	ANTENNA, 902-960MHz (Rig Antenna)	
222-6519	868MHz Antenna (Rig Antenna)	



**SUGGESTED PRICE LIST  
(F.O.B. PERRY, OKLAHOMA)**

**Effective April 1, 2023**

PART NO.	DESCRIPTION	MSRP (USD)
----------	-------------	------------

**DrillLok™ Remote/Base**

DrillLok™ is a remote disable feature that incorporates a "report" feature from the HDD unit back to a Handheld device. The report provides an indication to the tracking crew that the rig is disabled there by locking out any inadvertent motion of the drill string.

Drilllok radios

**DrillLok™ Mounting Accessories**

<b>JT5</b>	Shipped with: 350-4268 JT5 REMOTE DRILL LOCK
<b>JT9</b>	Shipped with: 350-2653 MOUNTING ASSY
<b>JT20</b>	Shipped with: 215-2288 RIG DISABLE HARNESS
<b>JT25</b>	Shipped with: 350-2653 MOUNTING ASSY
<b>JT30 / AT30</b>	Shipped with: 215-2288 RIG DISABLE HARNESS
<b>JT40</b>	Shipped with: 350-2653 MOUNTING ASSY
<b>JT60 / AT60</b>	Shipped with: 350-2653 MOUNTING ASSY
<b>JT100 / AT100</b>	Shipped with: 350-2653 MOUNTING ASSY

**Tracker DrillLok™ Retrofit Kit**

TK, TKD and TKQ Trackers can be upgraded to add DrillLok™ capability. The upgrades are performed by Subsite® factory or service centers. A service labor charge is applied in addition to the upgrade kit. Additional repairs and labor may be required and will be charged separately.

220-2462	TK series DrillLok™ retro-fit kit U.S.
220-2464	TK Series DrillLok™ retro-fit kit Canada
220-2465	TK Series DrillLok™ retro-fit kit German
220-2466	TK Series DrillLok™ retro-fit kit Sweden
220-2467	TK Series DrillLok™ retro-fit kit Aus/NZ
220-2468	TK Series DrillLok™ retro-fit kit EU Har
	1 hour Service Labor charge applied in addition to the upgrade kit

**SUGGESTED PRICE LIST  
(F.O.B. PERRY, OKLAHOMA)**

**Effective April 1, 2023**

PART NO.	DESCRIPTION	MSRP (USD)
----------	-------------	------------

**TD RECON Display**

The display is available as an in-dash mount (TD) or remote mount (TDR). Both styles of the display presents information displayed by the tracker at a distance up to 2000 ft (609.6 m) with the UHF radio. The display utilizes an ISM radio to communicate to the tracker, radio frequency is country specific. See corresponding part numbers below. The display has internal data storage capabilities and works with TMS Plus and TSR software. The TK RECON Display works with all models of TK RECON trackers. Each display comes standard with mounting hardware required to install on drill rigs.

TD-Recon radios

**TK Recon Repeater**

The TK Recon Repeater is used exclusively with all models of TK Recon tracker and displays as well as the Marksman. The system has a lightweight, compact design that is highly durable and is offered as a range extender and a tool to combat line of sight issues found on the HDD jobsite. The TK Recon Repeater leverages a simple to use, single button operation which features more than 50 hours of continuous battery life and the ability to mount to any ¼"-20 accessory.

Repeater radios

**TK/TD RECON Parts and Accessories**

See Tracker and Display Parts and Accessory section under the TK series for common parts such as cases, bags and stands. See accessories below specific to the RECON series.

- 220-2407 TDR DISPLAY KIT
- 220-2769 REPEATER MAG MOUNT KIT
- 220-2498 Battery Tray Final Assy, Alk & NiMH
- 220-2500 Battery Tray Final Assy, Li-Ion
- 220-2575 TDR Recon Mag Mount Kit – DW 900MHz
- 220-2577 TDR Recon Mag Mount Kit – Other 900MHz
- 222-5260 TK Recon Battery Cap
- 222-5264 O-Ring
- 222-5531 Universal Charger, US/North America
- 222-6520 Universal Charger Travel Adapter Set
- 220-6775 LI ION BATTERY KIT
- 222-5521 SMART LI-ION CHARGE TRACKER BAT,TK RECON
- 222-5592 900MHz Rubber Duck Ant/Male (Remote Ant)
- 222-6517 ANTENNA, 902-960MHz (Rig Antenna)
- 222-6519 868MHz Antenna (Rig Antenna)
- 222-6530 2.4GHz antenna 2.0dBi STD SMA
- 222-6540 Seven band external antenna, TNC

**SUGGESTED PRICE LIST  
(F.O.B. PERRY, OKLAHOMA)**

**Effective April 1, 2023**

PART NO.	DESCRIPTION	MSRP (USD)
----------	-------------	------------

**15T Beacon Transmitter**

15T series beacons are available in a single 29 kHz frequency (15T1) or a three frequencies 12/20/29 kHz (15T3). They work with the TK or TK RECON tracker series. Prior to a bore, the 15T3 beacon can be configured with two of three frequencies 12 kHz, 20 kHz, and 29 kHz and can be configured with standard, high or extreme power. The 15T1 is 29 kHz and standard power level. The 15T series beacons are Grade pitch. The beacons are a universal length @ 15 in (381 mm) and an 1.25 in (31.7 mm) diameter, which fits into housings that are designed for a DCI transmitter. An optional 220-2356 hard case, batteries and isolators are available in the selectable parts section.

- 102-1632 15T1 Beacon, single 29 kHz frequency, standard power level
- 102-1588 15T3 Beacon, configurable 12, 20 or 29 kHz frequency; standard, high or extreme power levels

**17T Beacon Transmitter**

17T series beacon transmitters are available in multiple frequency and power options. They work with the TK or TK RECON tracker series. Prior to a bore, the 17T4 and 17T4G beacons can be configured with two of four frequencies 1.5 kHz, 12 kHz, 20 kHz, and 29 kHz. It can also be configured with standard, high or extreme power. The 17T1 is 29 kHz and standard power. The 17T1H is 29 kHz and high power. "G" designates Grade pitch, everything else is Standard Pitch. The beacon comes standard with flat-top/half-moon isolators for side-load housings. An optional 220-1090 hard case, batteries and other isolators are available in the selectable parts section. Length is 17.8 in (452 mm), diameter is 1.5 in (38 mm).

- 102-1715 17T1 BEACON, BASE UNIT  
29 kHz frequency, standard power level
- 102-1716 17T1H BEACON, BASE UNIT  
29 kHz frequency, high power level
- 102-1717 17T4 BEACON  
1.5, 12, 20 and 29 kHz frequencies; standard, high or extreme power levels, standard pitch
- 102-1718 17T4G  
1.5, 12, 20 and 29 kHz frequencies; standard, high or extreme power levels, grade pitch

**19T Beacon Transmitter**

19T beacon is available in a three frequencies 12/20/29 kHz (19T3). It works with the TK or TK RECON tracker series. Prior to a bore, the 19T3 beacon can be configured with two of three frequencies 12 kHz, 20 kHz, or 29 kHz and can be configured with standard, high or extreme power. The 19Ts beacon is Grade pitch. The beacons are a universal length @ 19 in (482 mm) and an 1.25 in (31.7 mm) diameter, which fits into housings that are designed for a DCI transmitter. An optional 220-2565 hard case, batteries and isolators are available in the selectable parts section.

- 102-1631 19T3  
configurable 12, 20 and 29 kHz frequencies; standard, high or extreme power levels



**SUGGESTED PRICE LIST  
 (F.O.B. PERRY, OKLAHOMA)**
**Effective April 1, 2023**

PART NO.	DESCRIPTION	MSRP (USD)
<b>Tracker and Display Parts and Accessories</b>		
220-2239	TDR Mag Mount Kit - Ditch Witch for USA, Canada, Australia, and Russia	
220-2248	TDR Mag Mount Kit - DW Low Freq for Germany, Sweden, & Other European Union Countries	
220-2247	TDR Mag Mount Kit - Other Drill for USA, Canada, Australia, and Russia	
220-2249	TDR Mag Mount Kit - Other Drill Low Freq for Germany, Sweden, & Other European Union Countries	
220-2225	PLATE, RAM Mount	
222-4411	TK RECON TRACKER STAND, SMALL	
222-4105	TK RECON TRACKER STAND, LARGE	
222-6213	3220 HARD CASE, TRACKER COMBO	
220-2383	Carry Bag, W/ Blank Strap (830)	
222-4163	750 TO TD JUMPER	
222-4166	ON-DASH CONTROL HARNESS	
222-4191	ARM, DOUBLE SOCKET, 1" BALL, COMPOSITE	
222-4302	Cable Assembly, SMA – BNC, RG174	
222-6212	EVA CASE, TRACKER COMBO	
220-2661	TK RECON SWIVEL BASE MOUNT	

**Trac Management System (TMS) Plus**

Trac Management System (TMS) Plus is an integrated planning and mapping system for Horizontal Directional Drilling. The TMS Plus will work on any Jet Trac® equipped with the required Subsite® systems. Requirements for the TMS Plus include a TD / TDR Display, a TK / TKD / TKQ Tracker, 750 / 752 Display, a 750 / 752 Tracker and any Ditch Witch® pitch beacon. A computer capable of running Windows 95 or higher is needed. The TMS Plus Kit includes a cable to connect from the unit to the computer, a software disc, and a manual.

TMS base unit

220-054	TMS PLUS CD ONLY OPTION
220-1006	TMS Plus Dealer CD
222-2335	USB DATA CABLE





DITCH WITCH® HDD TOOLING  
**MAKE EVERY  
FOOT COUNT.**



HDD TOOLING CATALOG



Ditch Witch®



# FIRST JET TRAC®



RS8/60 JET TRAC



JT2321



JT1720



JT4020



JT520



JT2720  
ALL TERRAIN



JT3020 AND JT3020 ALL  
TERRAIN



JT100  
ALL TERRAIN



JT30 AND JT30  
ALL TERRAIN



JT20



JT9



JT10



JT20XP

1988

1990

1993

1995

1996

1997

1998

1999

2000

2004

2007

2009

2011

2012

2013

2014

2016

2017

2018

2019

DITCH WITCH® SLANT  
NOSE TECHNOLOGY

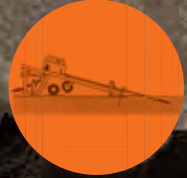

440A JET TRAC



JT820



JT920

JT7020



JT2720



JT1720 MACH 1



JT2020 MACH 1



JT922



JT5



JT25



JT60 AND JT60  
ALL TERRAIN



JT40 AND AT40 ALL  
TERRAIN



JT24



# THE PARTS YOU NEED. THE SUPPORT YOU DESERVE.

We know what it's like on the jobsite. You need to stay on schedule to stay profitable. That's why we offer everything an HDD operation needs. Durable parts that deliver unmatched value and performance, backed by knowledgeable, experienced dealers providing expert service and support.

We're here to help you get the job done—efficiently and effectively. After all, **We're In This Together.**

## TABLE OF CONTENTS

<b>05</b> Saver Subs	<b>58</b> Universal Housings & Bits
<b>06</b> Drill Pipe	<b>62</b> Backreamers
<b>15</b> Transition Subs & Starter Rods	<b>74</b> Pullers, Swivels & Tabs
<b>18</b> Quick Connect Systems	<b>80</b> Nozzles
<b>32</b> Dirt Housings & Bits	<b>82</b> Quick Wrenches & Jaws
<b>42</b> TriHawk® HD Housings & Bits	<b>88</b> Vacuum Accessories
<b>50</b> RockMaster® AT Housings & Bits	<b>90</b> Uptime Kits
<b>56</b> All Terrain Air Hammer	



# SAVER SUBS

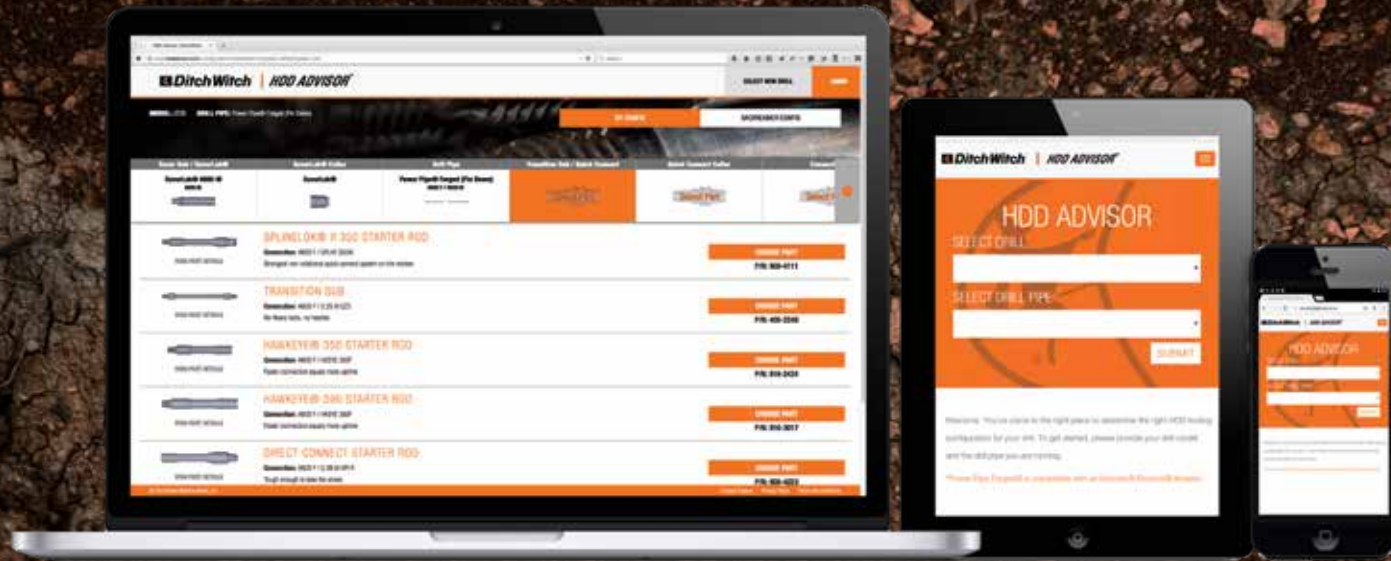

## HDDADVISOR.COM

### SPEND LESS TIME CHOOSING TOOLS AND MORE TIME USING THEM.

HDD Advisor®—an industry first—is a free tool that helps you quickly and confidently determine the right tooling configuration for your Ditch Witch® or Vermeer® directional drill.

Sign up today for an HDD Advisor account. Now, with more functionality than ever before.

- Save
- Print
- Share
- Modify/update with new tooling
- Create notes
- View pricing

We're In This Together.

For more, visit [ditchwitch.com/parts-service](http://ditchwitch.com/parts-service).

## SAVERLOK® SYSTEMS

Our new SaverLok Systems are quick and easy to install and replace. There are no special tools required, and no overnight downtime for your rig is needed. A few minutes is all you need to get up and running.



### SAVER SUBS

Made of high-grade steel, our solid, one-piece units are engineered with the same proprietary gauges used on all Ditch Witch® drill string components.

PART NUMBERS	DRILL THREAD	MODEL(S)
400-828	1.21	JT520
300-7827	1.1	JT5
400-2242	#200 (HIWS1)	JT520 / JT5
301-891	1.41	JT920 / JT920L / JT921 / JT921S
300-2340	1.41	JT922 Fine Thread
400-1589	1.3	JT9 / JT10 / JT922 Coarse Thread
400-2728	#200 (HIWS1)	JT9 / JT10
400-604	1.47	JT1220M1
400-2237	#250	JT1220M1
301-892	1.69	JT1720M1
400-905	1.94	JT2020M1 / JT20
400-2304	#400 (HIWS1)	JT1220M1 / JT20
400-2235	#600 (HIWS1)	JT2020M1 / JT20
400-1229	2.11	JT2720M1
400-1223	2.11	JT3020 / JT30
400-2232	#600 (HIWS1)	JT3020 / JT30
400-1134	2.59	JT4020M1
400-1132	3.27	JT7020 / JT8020 / JT100
400-2115	3.27	JT100 New Gear Box
400-2241	#800 (HIWS1)	JT7020 / JT8020 / JT100-Legacy
400-2276	#800 (HIWS1)	JT100 New Gear Box
400-1226	2.77 DS	AT2720
400-1225	2.77 SS	AT2720 Cobble
400-1222	2.77 DS	AT30
400-1221	2.77 SS	AT30 Cobble
400-1133	3.25 SS	AT4020
400-1375	3.44 SS	AT100 New Gear Box
400-2234	#800 (HIWS1)	AT100 New Gear Box
300-5735	3.27	AT100 New Gear Box

PART NUMBERS	DRILL THREAD	MODEL(S)
400-1634	1.94-F SaverLok	JT2020 / JT20
400-2255	#600 SaverLok	JT2020 / JT20
400-2254	#400-F SaverLok	JT2020 / JT20
400-3054	1.76-F SaverLok	JT24
400-3067	#600-F SaverLok	JT24
400-3076	#600-M SaverLok	JT24
400-2037	2.11-F SaverLok	JT25 / JT30
400-2038	#600-F SaverLok	JT25 / JT30
400-2174	#600-M SaverLok	JT25 / JT30
400-2156	2.77 DS-F SaverLok	AT30
400-2219	2.77 SS-F SaverLok	AT30
400-2215	2.11-F SaverLok	AT30
400-2233	#600-F SaverLok	AT30
400-2377	2.10-F SaverLok	JT40
400-2598	#700-F SaverLok	JT40
400-2499	#700-M SaverLok	JT40
400-2378	2.95-F SaverLok	AT40
400-2159	2.59-F SaverLok	JT4020M1
400-2150	2.46-F SaverLok	JT60 / AT60
400-2253	#900-F SaverLok	JT60 / AT60
400-2148	3.25-F SaverLok	JT60 / AT60
400-2166	3.27-F SaverLok	JT100 / AT100
400-2256	#800-F SaverLok	JT100 / AT100
400-2169	3.44 SS-F SaverLok	JT100 / AT100

PART NUMBERS	TYPE	MODEL(S)
301-5719	SaverLok Collar	JT2020 / JT20
302-2181	SaverLok Collar	JT24
301-3830	SaverLok Collar	JT25 / JT30
400-2155	SaverLok Collar	JT4020M1
301-7018	SaverLok Collar	JT40
301-5732	SaverLok Flange	JT60 / AT60 / JT100 / AT100
301-6062	SaverLok Collar	AT30



NOTE: Remember to change the saver sub every time you change drill pipe. A saver sub is a wear item that will make up to every joint of pipe on every job. Be sure to regularly check for wear and replace when needed.

SAVER SUBS

To find your dealer, visit [ditchwitch.com/find-a-dealer](http://ditchwitch.com/find-a-dealer).



# A BETTER INVESTMENT. STRAIGHT UP.

We know the demands placed on drill pipe, the careful balance of strength and flexibility required to ensure maximum performance of the drill and the drill string. We know because we are the only directional drill manufacturer that designs and manufactures its own drill pipe. Producing long-lasting Ditch Witch® drill pipe begins with the highest-quality steel and involves a precise, time-tested series of steps. After machining, every tool joint is inspected and gauged to ensure quality and reliability. Our proven welding technique does not produce stress concentration points that are common on competitors' pipe. After welding, we inspect each pipe, and section a piece of pipe from each batch to ensure weld quality and integrity. You expect a lot from our drill pipe. So we put a lot into it.



## POWER PIPE® HD, FLUID MISER® II

Power Pipe HD, Fluid Miser II is a premium drill pipe designed specifically for Ditch Witch® drills. It features an improved bend radius with the strongest, most wear-resistant tool joints in the industry. It includes a wear indicator groove and allows you to pressurize your drill string faster, while reducing mud scaling and reducing spillage during pipe breakout. Meets S-135 strength standards and made with U.S. and German steel to provide more scratch-resistant material and improve the life of the pipe.

PART NUMBERS	PIPE BODY X TOOL JOINT X THREAD	DRILL PIPE LENGTH	BEND RADIUS	MODEL(S)
355-1150	1.58" x 2.125" x 1.3	6' / 1.8 m	82' / 25.0 m	JT922 Coarse Thread / JT9 / JT10
355-1229	1.58" x 2.00" x 1.41	6' / 1.8 m	82' / 25.0 m	JT922 Fine Thread
355-1151	2.06" x 2.5" x 1.69	10' / 3 m	107' / 32.6 m	JT1720M1
355-1107	2.06" x 2.63" x 1.94	9.8' / 3 m	107' / 32.6 m	JT2020 / JT20
355-1313	2.25" x 2.63" x 1.76	10' / 3 m	117' / 35.6 m	JT24
355-1111	2.38" x 2.75" x 2.11	9.8' / 3 m	123' / 37.5 m	JT25 / JT2720M1 / JT30
355-1211	2.81" x 3.13" x 2.10	15' / 4.57 m	146' / 44.5 m	JT40
355-1100	3.06" x 3.5" x 2.46	15' / 4.57 m	170' / 51.8 m	JT60

"I prefer to buy Ditch Witch® Power Pipe® HD, Fluid Miser® II for my JT20 because it saves us time, money and the high-quality pipe lasts longer."

- Gene Cox, MidCon Underground Construction, Inc., Denton, NE



## POWER PIPE® HD, UNLINED

Power Pipe HD Unlined is a premium drill pipe designed specifically for Ditch Witch drills. This unlined pipe features an improved bend radius, and a wear indicator groove with double shoulders for the strongest, most wear-resistant tool joints in the industry. Meets S-135 strength standards.

PART NUMBERS	PIPE BODY X TOOL JOINT X THREAD	DRILL PIPE LENGTH	BEND RADIUS	MODEL(S)
355-1038	1.13" x 1.875" x 1.1	4.9' / 1.5 m	70' / 21.3 m	JT5
355-1228	1.58" x 2" x 1.41	6' / 1.8 m	82' / 25.0 m	JT922 Fine Thread
355-1149	1.58" x 2.125" x 1.3	6' / 1.8 m	82' / 25.0 m	JT922 Coarse Thread / JT9 / JT10
355-1152	2.06" x 2.5" x 1.69	7' / 3 m	107' / 32.6 m	JT1720
355-1106	2.06" x 2.63" x 1.94	10' / 3 m	107' / 32.3 m	JT2020 / JT20
355-1312	2.25" x 2.63" x 1.76	10' / 3 m	117' / 35.6 m	JT24
355-1094	2.38" x 2.75" x 2.11	9.8' / 3 m	123' / 37.5 m	JT25 / JT2720M1 / JT30
355-1210	2.81" x 3.13" x 2.10	15' / 4.57 m	146' / 44.5m	JT40
355-1079	3.06" x 3.5" x 2.46	15' / 4.57 m	170' / 51.8 m	JT60
355-1200	3.63" x 4" x 3.27	14.75' / 4.5 m	205' / 56.5 m	JT7020M1 / JT8020M1 / JT100M1





## FORGED HD

Designed specifically for Ditch Witch® drills, the Forged HD drill pipe is forged from a single piece of 4130 steel. It's compatible with all Power Pipe® HD, Fluid Miser® II and unlined pipe. The Forged HD features the same great bend radius as our Fluid Miser II pipe, with the strongest tool joints and most wear-resistant threads in the industry. Meets S-135 strength standards and made with U.S. and German steel to provide more scratch-resistant material and improve the life of the pipe.

PART NUMBERS	PIPE BODY X TOOL JOINT X THREAD	DRILL PIPE LENGTH	BEND RADIUS	MODEL(S)
355-1301	1.63" x 2.00" x 1.3	6' / 1.8 m	84' / 25.6 m	JT9 / JT922 Coarse Thread / JT10
355-1246	2.10" x 2.50" x 1.94	10' / 3.05 m	109' / 33.2 m	JT20
355-1233	2.38" x 2.63" x 1.76	10' / 3 m	123' / 37.5 m	JT24
355-1244	2.38" x 2.75" x 2.11	9.8' / 3.05 m	123' / 37.5 m	JT25 / JT30
355-1303	2.75" x 3.13" x 2.10	15' / 4.57 m	143' / 43.6 m	JT40



## FORGED HDX

Designed to match competitive threads, the Ditch Witch® Forged HDX drill pipe is forged from the highest-quality steel and meets S135 strength standards. It features thicker wall tubing than competitive pipe, delivering superior stability without compromising bend radius.

PART NUMBERS	PIPE BODY X TOOL JOINT X THREAD	DRILL PIPE LENGTH	BEND RADIUS	MODEL(S)
355-1349	1.63" x 1.88" x #200	6' / 1.8 m	82' / 25 m	JT9 / JT10 / D9X13 / D10X15
355-1350	2.38" x 2.63" x #600	10' / 3.05 m	123' / 37.5 m	JT20 / JT24 / JT25 / JT30 / D24X40 / D23X30
355-1352	2.75" x 3.13" x #700	15' / 4.57 m	143' / 43.6 m	JT40



## POWER PIPE®, FLUID MISER® II\*LEGACY

Our patented manufacturing process produces something no one else can: the strongest pipe available. Fluid Miser II features our exclusive lining to reduce drilling fluid volume of the pipe by as much as 76 percent, allowing your drill string to pressure up faster and clean up quicker.

PART NUMBERS	PIPE BODY X TOOL JOINT X THREAD	DRILL PIPE LENGTH	BEND RADIUS	MODEL(S)
369-227	1.63" x 2" x 1.41	10' / 3.05 m	100' / 30.5 m	JT920L
369-048	1.58" x 2" x 1.41	6.6' / 2 m	100' / 30.5 m	JT920 / JT921
401-239	1.82" x 2.38" x 1.47	10' / 3.05 m	120' / 36.6 m	JT1220
369-235	2.23" x 2.75" x 1.94	9.8' / 3 m	145' / 44.2 m	JT2720
369-221	2.63" x 3.25" x 2.40	14.75' / 4.5 m	150' / 45.7 m	JT4020
369-804	2.81" x 3.5" x 2.59	14.75' / 4.5 m	185' / 56.4 m	JT4020M1



## POWER PIPE®, UNLINED\*LEGACY

Power Pipe is a high-strength, low-alloy steel pipe, delivering the perfect balance of tensile strength and flexibility.

PART NUMBERS	PIPE BODY X TOOL JOINT X THREAD	DRILL PIPE LENGTH	BEND RADIUS	MODEL(S)
355-1066	1.13" x 1.88" x 1.10	4.9' / 1.5 m	70' / 21.3 m	JT520
355-1052	1.13" x 1.75" x 1.21	4.9' / 1.5 m	70' / 21.3 m	JT520
400-842	1.63" x 2" x 1.41	10' / 3.05 m	100' / 30.5 m	JT920L
400-963	1.58" x 2" x 1.41	6.6' / 2 m	100' / 30.5 m	JT920 / JT921
355-1005	1.82" x 2.38" x 1.47	10' / 3.05 m	120' / 36.6 m	JT1220
400-844	2.23" x 2.75" x 1.94	9.8' / 3 m	145' / 44.2 m	JT2720
400-846	2.63" x 3.25" x 2.4	14.75' / 4.5 m	150' / 45.7 m	JT4020
400-847	2.81" x 3.5" x 2.59	14.75' / 4.05 m	185' / 56.4 m	JT4020M1





## ALL TERRAIN PIPE

The patented mechanical dual-pipe All Terrain system features a strong drive rod that turns inside an outer pipe. This enables Ditch Witch® All Terrain directional drills to utilize a mechanical transfer of power to the cutting head. This method delivers a more efficient and productive system that outperforms all other rock systems in their horsepower class. Made with U.S. and German steel.

PART NUMBERS	PIPE BODY X TOOL JOINT X THREAD	DRILL PIPE LENGTH	BEND RADIUS	MODEL(S)
355-1354	1.94" x 3.25" x 2.77DS / LR	9.3' / 2.84 m	145' / 44.2 m	AT30 / AT2720
355-1351	2.23" x 3.25" x 2.77DS	9.3' / 2.84 m	145' / 44.2 m	AT30 / AT2720
355-1338	2.94" x 3.25" x 2.77DS / FLUSH	9.3' / 2.84 m	153' / 46.6 m	AT30 / AT2720
355-1195	3.07" x 3.75" x 2.95DS	15' / 4.6 m	170' / 51.8 m	AT40
355-1258	3.63" x 4.13" x 3.25SS	14.25' / 4.34 m	205' / 62.5 m	AT4020 / AT60
355-1254	3.63" x 4.50" x 3.44SS	14.1' / 4.31 m	205' / 62.5 m	AT100

DS = Double Shoulder    LR = Lead Rod    SS = Single Shoulder

## ROD WIPERS

PART NUMBERS	MODEL(S)
116-515	JT520 / JT5
149-578	JT920 / JT920L / JT921 / JT922 / JT9 / JT10
149-974	JT1220
362-2078	AT30 Flush / AT40
149-973	JT1720 / JT2020 / JT2720 / JT20 / JT24 / JT30 / JT40 / AT2720 / AT30 / HIWS2
362-2694	JT40
117-627	JT4020M1 / JT60
157-196	JT7020M1 / JT8020M1 / JT100M1 / AT4020 / AT60 / AT10



## TOOL JOINT COMPOUNDS

PART NUMBERS	CONTAINER SIZE	DESCRIPTION
256-026	14 oz	Artic GD Cartridge
256-1003	14 oz	ENVTL Friendly Cartridge
256-663	14 oz	STD Cartridge
256-1000	1 gal	STD Spray
259-858	2 gal	STD Spray
256-031	2 gal	SUMR Spray
256-1005	2 gal	ENVTL Friendly
256-1006	5 gal	ENVTL Friendly
256-025	5 gal	SUMR Spray
256-027	5 gal	STD Spray







# INDUSTRY'S STRONGEST GUARANTEE

## BREAK AN HD DRILL PIPE, WE'LL REPLACE IT.

With our patented manufacturing process, we make the strongest drill pipe on the market. Even better, we offer the industry-exclusive HD Drill Pipe Guarantee to replace them if they break, completely free.

Applies to Power Pipe HD Fluid Miser®, Power Pipe HD Unlined, Forged HD, and Forged HDX drill pipe. See dealer for details.



# DRILL PIPE BEST PRACTICES.

- Set up unit in accordance with operator's manual.
- Securely anchor drilling unit.
- Precondition the joint by applying recommended tool joint compound to all shoulder and thread surfaces of the box and pin, connect the two parts together, torque tight, separate fully, then repeat the process one or two times.
- Make up and break out tool joints correctly.
- Assemble and disassemble tool joints at a speed that does not cause damage to the threads by keeping rotation speed and thrust speed synchronized.
- Apply proper torque to all tool joints.
- Do not exceed bend radius when steering or making corrections.
- Keep threads clean and lubricated.
- Use correct drilling fluid for soil conditions as recommended by your local Ditch Witch® dealer.
- Rotate the lead pipe to the back of the pipebox periodically to spread wear through the entire drill string.
- Check the wear indicator grooves to judge the rate and degree of wear on the tool joint. This helps the operator understand material wear and longevity of the pipe.
- Refer to your operator's manual for complete drill pipe care, maintenance and operation.



WEAR INDICATOR GROOVES





**AS REAL  
AS IT GETS.  
WITHOUT ALL  
THE MUD.**

**BIGGER THINKING  
BROUGHT DOWN  
TO SIZE.**



**GET REAL-WORLD TRAINING WITH THE HDD VR SIMULATOR.**

The future of HDD training is here with Virtual Reality. This interactive experience mimicks real-world training conditions, giving operators the chance to tackle jobsite challenges in a virtual environment. This simulator helps new and experienced crews fine-tune their skills while protecting your valuable equipment.



Our transition subs and starter rods help absorb stress in the connections between drill pipe, beacon housings and backreamers. Their high-strength, low-alloy steel is heat-treated and precision-gun-drilled to produce maximum durability. Using the same proprietary gauges as we use on our saver subs, drill pipe, beacon housings, backreamers, and connectors ensures the tightest possible connection throughout the drill string, for worry-free performance downhole.

TRANSITION SUBS & STARTER RODS





## TRANSITION SUBS



Transition subs connect directly between the drill pipe and the housing or backreamer. The overall length of the transition sub allows you to pull into the machine wrenches to make up or break loose from the drill pipe.

PART NUMBERS	DESCRIPTION	MODEL(S)
400-1260	1.10 M / 1.10 M	JT5
369-213	1.21 M / 1.21 F	JT520
369-326	1.41 M / 1.41 F	JT920 / JT920L / JT921 / JT922
400-2217	1.41 M / 2.0 M API IF	JT920 / JT920L / JT921 / JT922
400-1427	1.30 M / 1.41 F	JT922 Coarse Thread / JT9 / JT10
400-2216	1.30 M / 2.0 M API IF	JT922 Coarse Thread / JT9 / JT10
401-005	1.47 M / 1.94 M	JT1220M1
400-2193	1.47 M / 2.0 M API IF	JT1220M1
368-985	1.69 M / 1.69 F	JT1720M1
400-2747	1.76 M / 2.38 M API R	JT24
400-2202	1.94 M / 2.0 M API IF	JT20 / JT2020 / JT20XP
400-2192	1.94 M / 2.38 M API R	JT20 / JT2020 / JT20XP
401-319	1.94 M / 1.94 M	JT20 / JT2020 / JT20XP
400-231	2.11 M / 2.59 M	JT25 / JT2720M1 / JT3020 / JT30
400-2191	2.11 M / 2.38 M API R	JT25 / JT2720M1 / JT3020 / JT30
400-2466	2.10 M / 2.88 M API R	JT40
400-575	2.59 M / 2.59 M	JT4020M1
400-1419	2.59 M / 2.88 M API R	JT4020M1
400-2268	2.46 M / 3.27 M	JT60
400-2269	2.46 M / 2.88 M API R	JT60
400-1479	3.27 M / 3.5 M API IF	JT7020 / JT8020 / JT100
369-222	3.27 M / 3.27 M	JT7020 / JT8020 / JT100

## ALL TERRAIN TRANSITION SUBS

All Terrain transition subs allow you to run dirt tooling with the patented All Terrain Power Pipe®.



PART NUMBERS	DESCRIPTION	MODEL(S)
400-057	2.52 M / 2.59 M	AT2720 / AT30
369-410	2.77 M / 2.59 M	AT2720 / AT30
400-2305	2.77 M / 2.38 M API R	AT30
400-2709	2.95 M / 2.59 M	AT40
400-2465	2.95 M / 2.88 M API R	AT40
400-2684	2.95 M / 3.50 M API IF	AT40
400-2710	2.95 M / 3.27 M API R	AT40
400-685	3.25 M / 2.59 M	AT4020
400-1679	3.25 M / 2.88 M API R	AT4020 / AT60
401-143	3.25 M / 3.27 M	AT4020 / AT60
400-1383	3.44 M / 3.27 M	AT100
400-1678	3.44 M / 3.5 M API IF	AT100
400-3077*	2.95 M / 3.25 F	AT40

\*Note: 400-3077 is a dual rod transition sub.

## ALL TERRAIN CONNECTORS

Featuring a compact design, All Terrain connectors allow you to run dirt tooling with the patented All Terrain Power Pipe®.



PART NUMBERS	DESCRIPTION	MODEL(S)
400-2766	2.77 M / 2.88 M API R	AT30
400-2767	2.77 M / 3.5 M API IF	AT30
400-2768	2.95 M / 2.88 M API R	AT40
400-2769	2.95 M / 3.5 M API IF	AT40
400-2770	3.25 M / 2.88 M API R	AT60
400-2771	3.25 M / 3.50 M API IF	AT60
400-2772	3.44 M / 2.88 M API R	AT100
400-2773	3.44 M / 3.5 M API IF	AT100

## HDX/HIWS1/HXT™ TRANSITION SUBS

No matter what drill pipe you run on your rig, we build compatible starter rods to give you the genuine Ditch Witch® performance you expect.

PART NUMBERS	DESCRIPTION	MODEL(S)
400-2294	#200 M / #200 M	JT520 / JT5
400-2293	#200 M / 1.10 M	JT520 / JT5
400-2284	#200 M / 2.0 M API IF	JT920 / JT921 / JT922
400-2285	#200 M / 1.94 M	JT920 / JT921 / JT922
400-2286	#200 M / 1.41 F	JT920 / JT921 / JT922
400-2289	#250 M / 2.0 M API IF	JT1220M1
400-2290	#250 M / 1.94 M	JT1220M1
400-2282	#400 M / 1.94 M	JT1220M1 / JT20
400-2278	#400 M / 2.0 M API IF	JT1220M1 / JT20
400-2279	#400 M / 2.38 M API	JT1220M1 / JT20
400-2283	#600 M / 1.94 M	JT20 / JT2020
400-2244	#600 M / 2.38 M API R	JT2020 / JT20 / JT25 / JT3020 / JT30
400-2245	#600 M / 2.59 M API R	JT2020 / JT20 / JT25 / JT3020 / JT30
400-2246	#600 F / 2.59 M API R	JT25
400-2685	#700 M / 2.88 M API R	JT40
400-2271	#900 M / 3.27 M	JT60
400-2272	#900 M / 2.88 M API R	JT60
400-2258	#800 M / 3.27 M	JT7020 / JT8020 / JT100
400-2257	#800 M / 3.5 M API IF	JT7020 / JT8020 / JT100
908-0802	#200 F / 2.11 M	D6X6 / D7X11 / D9X13
908-1702	#250 F / 2.38 M API R	D16X20
908-1705	#400 F / 2.38 M API R	D18X20 / D20X22 / D24X26
908-4227	#402 F / 2.38 M API R	D24X33
908-4223	#600 F / 2.38 M API R	D24X40
908-4229	#602 F / 2.38 M API R	D33X44 / D36X50 (#602)
908-4230	#650 F / 2.38 M API R	D33X44 / D36X50 (#650)
908-4241	#700 F / 2.38 M API R	D36X50 (#700)
908-4240	#702 F / 2.38 M API R	D36X50 (#702)
908-5187	#800 F / 2.88 M API R	D50X100 / D55X100 / D75X100 / D80X100
908-5198	#800 F / 3.50 M API R	D80X120 / D100X120 (#1000)
908-5194	#802 F / 2.88 M API R	D80X120 / D100X120 (#802)
908-5204	#802 F / 3.50 M API R	D80X120 / D100X120 (#802)
908-5185	#900 F / 2.88 M API R	D50X100 / D80X100
908-5201	#900 F / 3.50 M API R	D50X100 / D80X100
908-5206	#1000 F / 3.50 M API R	D80X120 / D100X120 (#1000) / DD110







**NO HEAVY TOOLS.**  
**NO HASSLES.**

Modern directional drilling rigs have greater torque and pullback forces, requiring increased control over HDD tooling and backreamers. Made for today's most powerful drills, the Hawkeye® quick connect system can withstand greater torque and pullback forces while improving steering control and extending tool life.

## EZ CONNECT ASSEMBLIES

### DITCH WITCH® THREAD

In addition to providing all the benefits of a transition sub, EZ Connect assemblies offer a quick method of changing out tooling without using the machine torque or quick wrenches.

PART NUMBERS	THREAD	DESCRIPTION	MODEL(S)
400-1261	1.10 M / 1.31 M EZ2	EZ Connect Assembly	JT5
400-1259		Transition Sub	
149-104		O-Ring	
369-258		Collar	
107-519		Retainer Bolt	
400-1384	1.3 M / 1.63 M EZ2	EZ Connect Assembly	JT922 Coarse Thread / JT9 / JT10
400-1178		Transition Sub	
149-911		O-Ring	
400-1860		Collar	
107-540		Retainer Bolt	
401-300	1.94 M / 2.0 M EZ2	EZ Connect Assembly	JT2020 / JT20
401-301		Transition Sub	
157-194		O-Ring	
400-1862		Collar	
107-521		Retainer Bolt	
400-2746	1.76 M / 2.0 M EZ2	EZ Connect Assembly	JT24
400-2745		Transition Sub	
157-194		O-Ring	
400-1862		Collar	
107-521		Retainer Bolt	
400-1507	2.77 DS / 2.25 M EZ3	EZ Connect Assembly	AT2720 / AT30
400-1506		Transition Sub	
149-548		O-Ring	
400-1864		Collar	
106-847		Retainer Bolt	
316-573		Inner Rod Support Block	
400-2462	2.10 M / 2.63 EZ2	EZ Connect Assembly	JT40
400-2461		Transition Sub	
149-041		O-Ring	
400-1865		Collar	
107-513		Retainer Bolt	
400-2464	2.95 M / 2.85-6 M EZ2	EZ Connect Assembly	AT40
400-2463		Transition Sub	
400-2391		Collar	
155-703		O-Ring	
155-074		Retainer Bolt	
400-2393	2.46-4 M / 2.85-6 M EZ2	EZ Connect Assembly	JT60
400-2389		Transition Sub	
155-703		O-Ring	
400-2391		Collar	
155-074		Retainer Bolt	
400-1674	3.27 M / 3.5 M EZ2	EZ Connect Assembly	JT8020M1 / JT100M1
400-1481		Transition Sub	
149-042		O-Ring	
368-815		Collar	
105-593		Retainer Bolt	





# EZ CONNECT ASSEMBLIES\*LEGACY

## DITCH WITCH® THREAD

PART NUMBERS	THREAD	DESCRIPTION	MODEL(S)
400-105	1.21 M / 1.31 M EZ2	EZ Connect Assembly	JT520
400-104		Transition Sub	
149-104		O-Ring	
369-258		Collar	
107-519		Retainer Bolt	
400-070	1.41 M / 1.63 M EZ2	EZ Connect Assembly	JT920 / JT920L / JT921 / JT922 Fine Thread
400-067		Transition Sub	
149-911		O-Ring	
400-1860		Collar	
107-540		Retainer Bolt	
400-918	1.47 M / 1.88 M EZ3	EZ Connect Assembly	JT1220M1
400-917		Transition Sub	
153-856		O-Ring	
400-1861		Collar	
106-847		Retainer Bolt	
400-001	1.69 M / 2.0 M EZ2	EZ Connect Assembly	JT1720M1
369-998		Transition Sub	
157-194		O-Ring	
400-1862		Collar	
107-521		Retainer Bolt	
369-814	2.11 M / 2.25 M EZ2	EZ Connect Assembly	JT2720M1
369-812		Transition Sub	
149-548		O-Ring	
400-1863		Collar	
107-521		Retainer Bolt	
400-095	2.59 M / 2.63 M EZ2	EZ Connect Assembly	JT4020M1
400-096		Transition Sub	
149-041		O-Ring	
400-1865		Collar	
107-513		Retainer Bolt	

Note: EZ3 are designed for the JT1220 and JT25/30 only.



# EZ CONNECT ASSEMBLIES

## HDX/HIWS1/HXT™ THREAD

PART NUMBERS	THREAD	DESCRIPTION	MODEL(S)
400-2296	#200 M / 1.31 M EZ2	EZ Connect Assembly	JT520 / JT5
400-2295		Transition Sub	
149-104		O-Ring	
369-258		Collar	
107-519		Retainer Bolt	
400-2288	#200 M / 1.63 M EZ2	EZ Connect Assembly	JT920 / JT920L / JT921 / JT922 / JT9 / JT10
400-2287		Transition Sub	
149-911		O-Ring	
400-1860		Collar	
107-540		Retainer Bolt	
400-2281	#400 M / 2.0 M EZ2	EZ Connect Assembly	JT1220M1 / JT20
400-2280		Transition Sub	
400-1862		Collar	
107-521		Retainer Bolt	
400-2292	#250 M / 1.88 M EZ3	EZ Connect Assembly	JT1220M1
400-2291		Transition Sub	
153-856		O-Ring	
400-1861		Collar	
106-847		Retainer Bolt	
400-2251	#600 M / 2.25 M EZ3	EZ Connect Assembly	JT2020 / JT20 / JT24 / JT25 / JT3020 / JT30
400-2247		Transition Sub	
149-548		O-Ring	
400-1864		Collar	
107-277		Retainer Bolt	
400-2252	#600 F / 2.25 M EZ3	EZ Connect Assembly	JT24 / JT25
400-2248		Transition Sub	
149-548		O-Ring	
400-1864		Collar	
107-277		Retainer Bolt	
400-2687	#700 M / 2.63 EZ2	Transition Sub	JT40
400-2686		Transition Sub	
149-041		O-Ring	
400-1865		Collar	
107-513		Retainer Bolt	
400-2522	#900 M / 2.85-6 M EZ2	EZ Connect Assembly	JT60
400-2523		Transition Sub	
155-703		O-Ring	
400-2391		Collar	
155-074		Retainer Bolt	
400-2260	#800 M / 3.5 M EZ2	EZ Connect Assembly	JT8020M1 / JT100M1
400-2259	#800 M / 3.5 M EZ	Transition Sub	
368-815		Collar	
105-593		Retainer Bolt	



# HAWKEYE®

## DITCH WITCH® THREAD

The revolutionary Hawkeye quick connect system is made specifically for today's more powerful drilling rigs. Our patented wear compensation design provides:

- Longer tool life
- Virtually eliminates cross threading
- Compatible with any machine
- Faster make up
- Through-collar lubrication



PART NUMBERS	THREAD	DESCRIPTION	MODEL(S)
918-0734	1.41 M / HKEYE 275 F	Hawkeye 275 Starter Rod Short	JT920 / JT920L / JT921 / JT922 Fine Thread
918-0759	1.41 M / HKEYE 275 F	Hawkeye 275 Starter Rod Long	JT920 / JT920L / JT921 / JT922 Fine Thread
918-0715		Hawkeye 275 Collar	
918-0722		O-Ring	
918-0736	1.3 M / HKEYE 275 F	Hawkeye 275 Starter Rod Short	JT922 Coarse Thread / JT9
918-0760	1.3 M / HKEYE 275 F	Hawkeye 275 Starter Rod Long	JT922 Coarse Thread / JT9
918-0715		Hawkeye 275 Collar	
918-0722		O-Ring	
918-0738	1.47 M / HKEYE 275 F	Hawkeye 275 Starter Rod Short	JT1220M1
918-0761	1.47 M / HKEYE 275 F	Hawkeye 275 Starter Rod Long	JT1220M1
918-0715		Hawkeye 275 Collar	
918-0722		O-Ring	
918-2454	1.69 M / HKEYE 350 F	Hawkeye 350 Starter Rod Short	JT1720M1
918-2492	1.69 M / HKEYE 350 F	Hawkeye 350 Starter Rod Long	JT1720M1
918-2439		Hawkeye 350 Collar	
918-2423		O-Ring	
918-2495	1.76 M / HKEYE 350 F	Hawkeye 350 Starter Rod	JT24
918-2439		Hawkeye 350 Collar	
918-2423		O-Ring	
918-2453	1.94 M / HKEYE 350 F	Hawkeye 350 Starter Rod Short	JT2020M1
918-2491	1.94 M / HKEYE 350 F	Hawkeye 350 Starter Rod Long	JT2020M1
918-2439		Hawkeye 350 Collar	
918-2423		O-Ring	
918-2455	2.11 M / HKEYE 350 F	Hawkeye 350 Starter Rod Short	JT24 / JT25 / JT2720M1 / JT3020 / JT30
918-2493	2.11 M / HKEYE 350 F	Hawkeye 350 Starter Rod Long	JT24 / JT25 / JT2720M1 / JT3020 / JT30
918-2439		Hawkeye 350 Collar	
918-2423		O-Ring	
918-3049	2.11 M / HKEYE 390 F	Hawkeye 390 Starter Rod Short	JT24 / JT25 / JT2720M1 / JT3020 / JT30
918-3091	2.11 M / HKEYE 390 F	Hawkeye 390 Starter Rod Long	JT24 / JT25 / JT2720M1 / JT3020 / JT30
918-3029		Hawkeye 390 Collar	
918-3019		O-Ring	
918-2471	2.77 DS M / HKEYE 350 F	Hawkeye 350 Starter Rod	AT2720M1 / AT30
918-2439		Hawkeye 350 Collar	
918-2423		O-Ring	
918-2470	2.52 SS M / HKEYE 350 F	Hawkeye 350 Starter Rod	AT2720M1 / AT30
918-2439		Hawkeye 350 Collar	
918-2423		O-Ring	
908-3058	2.77 DS M / HKEYE 390 F	Hawkeye 390 Starter Rod	AT2720M1 / AT30
918-3029		Hawkeye 390 Collar	
918-3019		O-Ring	
918-3057	2.52 SS M / HKEYE 390 F	Hawkeye 390 Starter Rod	AT2720M1 / AT30
918-3029		Hawkeye 390 Collar	
918-3019		O-Ring	



# HAWKEYE®

## DITCH WITCH® THREAD

PART NUMBERS	THREAD	DESCRIPTION	MODEL(S)
918-2459	2.59 M / HKEYE 350 F	Hawkeye 350 Starter Rod Short	JT4020 / JT4020M1
918-2494	2.59 M / HKEYE 350 F	Hawkeye 350 Starter Rod Long	JT4020 / JT4020M1
918-2439		Hawkeye 350 Collar	
918-2423		O-Ring	
918-3050	2.59 M / HKEYE 390 F	Hawkeye 390 Starter Rod Short	JT4020 / JT4020M1
918-3092	2.59 M / HKEYE 390 F	Hawkeye 390 Starter Rod Long	JT4020 / JT4020M1
918-3029		Hawkeye 390 Collar	
918-3019		O-Ring	
918-3648	2.59 M / HKEYE 426 F	Hawkeye 426 Starter Rod	JT4020M1
918-3640		Hawkeye 426 Collar	
918-3619		O-Ring	
918-3074	2.10 M / HKEYE 390 F	Hawkeye 390 Starter Rod	JT40
918-3676	2.10 M / HKEYE 426 F	Hawkeye 426 Starter Rod	JT40

# HAWKEYE

## HDX/HIWS1/HXT™ THREAD

PART NUMBERS	THREAD	DESCRIPTION	MODEL(S)
918-0756	#200 M / HKEYE 275 F	Hawkeye 275 Starter Rod	JT5 / JT922 / JT9
918-0715		Hawkeye 275 Collar	
918-0722		O-Ring	
918-0713	#200 F / HKEYE 275 F	Hawkeye 275 Starter Rod	D6X6 / D7X11 / D9X13
918-0715		Hawkeye 275 Collar	
918-0722		O-Ring	
918-0757	#250 M / HKEYE 275 F	Hawkeye 275 Starter Rod	JT1220
918-0715		Hawkeye 275 Collar	
918-0722		O-Ring	
918-2486	#400 M / HKEYE 350 F	Hawkeye 350 Starter Rod	JT1220 / JT20
918-2439		Hawkeye 350 Collar	
918-2423		O-Ring	
918-2437	#250 F / HKEYE 350 F	Hawkeye 350 Starter Rod	D16X20
918-2439		Hawkeye 350 Collar	
918-2423		O-Ring	
918-2468	#600 M / HKEYE 350 F	Hawkeye 350 Starter Rod	JT2020 / JT20
918-2439		Hawkeye 350 Collar	
918-2423		O-Ring	
918-2489	#600 M / HKEYE 350 F	Hawkeye 350 Starter Rod Long	JT24 / JT25 / JT30
918-2439		Hawkeye 350 Collar	
918-2423		O-Ring	
918-3067	#600 M / HKEYE 390 F	Hawkeye 390 Starter Rod	JT24 / JT25 / JT30
918-3029		Hawkeye 390 Collar	
918-3019		O-Ring	
918-3043	#700 / HKEYE 390 F	Hawkeye 390 Starter Rod	JT40
918-3029		Hawkeye 390 Collar	
918-3019		O-Ring	
918-3654	#700 / HKEYE 426 F	Hawkeye 426 Starter Rod	JT40
918-3460		Hawkeye 426 Collar	
918-3619		O-Ring	





# HAWKEYE®

## HDX/HIWS1/HXT™ THREAD

PART NUMBERS	THREAD	DESCRIPTION	MODEL(S)
918-3046	#250 F / HKEYE 390 F	Hawkeye 390 Starter Rod	D16X20
918-3029		Hawkeye 390 Collar	
918-3019		O-Ring	
918-2436	#400 F / HKEYE 350 F	Hawkeye 350 Starter Rod	D18X20 / D22X20 / D24X26
918-2439		Hawkeye 350 Collar	
918-2423		O-Ring	
918-3047	#400 F / HKEYE 390 F	Hawkeye 390 Starter Rod	D18X20 / D22X20 / D24X26
918-3029		Hawkeye 390 Collar	
918-3019		O-Ring	
918-2456	#402 F / HKEYE 350 F	Hawkeye 350 Starter Rod	D24X33
918-2439		Hawkeye 350 Collar	
918-2423		O-Ring	
918-3048	#402 F / HKEYE 390 F	Hawkeye 390 Starter Rod	D24X33
918-3029		Hawkeye 390 Collar	
918-3019		O-Ring	
918-2434	#600 F / HKEYE 350 F	Hawkeye 350 Starter Rod	JT24 / JT25 / D24X40
918-2439		Hawkeye 350 Collar	
918-2423		O-Ring	
918-3017	#600 F / HKEYE 390 F	Hawkeye 390 Starter Rod	JT24 / JT25 / D24X40
918-3029		Hawkeye 390 Collar	
918-3019		O-Ring	
918-3617	#600 F / HKEYE 426 F	Hawkeye 426 Starter Rod	JT24 / JT25 / D24X40
918-3640		Hawkeye 426 Collar	
918-3619		O-Ring	
918-2435	#602 F / HKEYE 350 F	Hawkeye 350 Starter Rod	D33X44 / D36X50
918-2439		Hawkeye 350 Collar	
918-2423		O-Ring	
918-3018	#602 F / HKEYE 390 F	Hawkeye 390 Starter Rod	D33X44 / D36X50
918-3029		Hawkeye 390 Collar	
918-3019		O-Ring	
918-3609	#602 F / HKEYE 426 F	Hawkeye 426 Starter Rod	D33X44 / D36X50
918-3640		Hawkeye 426 Collar	
918-3619		O-Ring	
918-2457	#650 F / HKEYE 350 F	Hawkeye 350 Starter Rod	D33X44 / D36X50
918-2439		Hawkeye 350 Collar	
918-2423		O-Ring	
918-3015	#650 F / HKEYE 390 F	Hawkeye 390 Starter Rod	D33X44 / D36X50
918-3029		Hawkeye 390 Collar	
918-3019		O-Ring	
918-3649	#650 F / HKEYE 426 F	Hawkeye 426 Starter Rod	D33X44 / D36X50
918-3640		Hawkeye 426 Collar	
918-3619		O-Ring	
918-2458	#700 F / HKEYE 350 F	Hawkeye 350 Starter Rod	D36X50 / D33X44 / D36X50
918-2439		Hawkeye 350 Collar	
918-2423		O-Ring	
918-3016	#700 F / HKEYE 390 F	Hawkeye 390 Starter Rod	D36X50 / D33X44 / D36X50
918-3029		Hawkeye 390 Collar	
918-3019		O-Ring	

Note: Collar and O-Ring sold separately.



# HAWKEYE® REAMER COLLARS

PART NUMBERS	DESCRIPTION	SIZE
918-2488	Reamer Collar	Hawkeye 350
918-2461	Pull Tab Connector	Hawkeye 350
918-3088	Reamer Collar	Hawkeye 390
918-3054	Pull Tab Connector	Hawkeye 390



# HAWKEYE SCREWS

PART NUMBERS	DESCRIPTION	SIZE
918-0618	Socket Head Cap Screw	Hawkeye 275
918-0719	Plug	Hawkeye 275
918-0718	Nozzle	Hawkeye 275
918-0001	Socket Head Cap Screw	Hawkeye 350-426
918-2419	Plug	Hawkeye 350-426
918-2418	Nozzle	Hawkeye 350-426



# LPT QUICK CONNECT

Our LPT quick connects are specifically designed to fit your Vermeer® rig.

PART NUMBERS	THREAD	DESCRIPTION	MODEL(S)
400-2249	#600 M / 2.125 LPT F	2.125 LPT Starter Rod	JT25 / JT3020 / JT30
908-4244		2.125 LPT Collar	
908-0812	#200 F / 1.62 LPT F	1.62 LPT Starter Rod	D6X6 / D7X7 / D9X13
908-0844		1.62 LPT Collar	
908-0101		1.62 LPT Bolt	
908-4273	#250 F / 2.125 LPT F	2.125 LPT Starter Rod	D16X20
908-4244		2.125 LPT Collar	
908-4272	#400 F / 2.125 LPT F	2.125 LPT Starter Rod	D18X20 / D20X22 / D24X26
908-4244		2.125 LPT Collar	
908-4275	#402 F / 2.125 LPT F	2.125 LPT Starter Rod	D24X33
908-4244		2.125 LPT Collar	
908-4274	#600 F / 2.125 LPT F	2.125 LPT Starter Rod	JT24 / JT25 / D24X40
908-4244		2.125 LPT Collar	
908-4277	#602 F / 2.125 LPT F	2.125 LPT Starter Rod	D33X44 / D36X50
908-4244		2.125 LPT Collar	
908-4278	#650 F / 2.125 LPT F	2.125 LPT Starter Rod	D33X44 / D36X50
908-4244		2.125 LPT Collar	
908-4280	#700 F / 2.125 LPT F	2.125 LPT Starter Rod	D36X50
908-4244		2.125 LPT Collar	
908-0104		2.125 LPT Bolt	
908-4288	2.12 LPT	Reamer Collar	
908-4285	2.12 LPT	Pull Tab Connector	



QUICK CONNECT SYSTEMS



## SPLINELOK® II

SplineLok II is the strongest non-rotational quick connect system on the market. Its patented double-pin system and its unique taper-to-taper interlock design ensure quick assembly and tooling removal.

PART NUMBERS	THREAD	DESCRIPTION	MODEL(S)
908-4271	1.69 M / SPLK 350 M	SplineLok II 350 Starter Rod Short	JT1720M1
908-4311	1.69 M / SPLK 350 M	SplineLok II 350 Starter Rod Long	JT1720M1
908-4270	1.94 M / SPLK 350 M	SplineLok II 350 Starter Rod Short	JT2020M1
908-4310	1.94 M / SPLK 350 M	SplineLok II 350 Starter Rod Long	JT2020M1
908-4318	1.76 M / SPLK 350 M	SplineLok II 350 Starter Rod Long	JT24
908-4276	2.11 M / SPLK 350 M	SplineLok II 350 Starter Rod Short	JT2020 / JT20 / JT25 / JT2720M1 / JT30M1
908-4312	2.11 M / SPLK 350 M	SplineLok II 350 Starter Rod Long	JT2020 / JT20 / JT25 / JT2720M1 / JT30M1
908-4281	2.59 M / SPLK 350 M	SplineLok II 350 Starter Rod Short	JT4020M1
908-4313	2.59 M / SPLK 350 M	SplineLok II 350 Starter Rod Long	JT4020M1
908-4376	2.10 M / SPLK 350 M	SplineLok II Starter Rod Long	JT40
908-4315	#700 M / SPLK 350 M	SplineLok II Starter Rod Long	JT40
908-4300	2.72 DS M / SPLK 350 M	SplineLok II 350 Starter Rod Short	AT30
908-4301	2.52 SS M / SPLK 350 M	SplineLok II 350 Starter Rod Short	AT30
908-4174	#250 F / SPLK 350 M	SplineLok II 350 Starter Rod Short	D16X20
908-4182	#400 F / SPLK 350 M	SplineLok II 350 Starter Rod Short	D18X20 / D20X22 / D24X26
908-4113	#402 F / SPLK 350 M	SplineLok II 350 Starter Rod Short	D24X33
908-4111	#600 F / SPLK 350 M	SplineLok II 350 Starter Rod Short	JT24 / JT25 / D24X40
908-4112	#602 F / SPLK 350 M	SplineLok II 350 Starter Rod Short	D33X44 / D36X50
908-4221	#650 F / SPLK 350 M	SplineLok II 350 Starter Rod Short	D33X44 / D36X50
908-4279	#700 F / SPLK 350 M	SplineLok II 350 Starter Rod Short	D36X50 / JT40
908-1721	#400 M / SPLK 350 M	SplineLok II 350 Starter Rod Short	JT1220 / JT20
908-4243	#600 M / SPLK 350 M	SplineLok II 350 Starter Rod Short	JT20
908-4257	#600 M / SPLK 350 M	SplineLok II 350 Starter Rod Short	JT25 / JT30
908-4258	#700 M / SPLK 350 M	SplineLok II 350 Starter Rod Short	D33X44 / D36X50 / JT40
908-4104		Solid Pins	
908-0036		Coiled Pins	
908-4009		O-Ring	



## CONNECTORS

Ditch Witch® HDD Tooling offers the widest range of connectors available, so you can adapt to virtually any drilling situation. You'll find exactly what you need to establish solid pin-to-pin or pin-to-box connections. And if you don't, we'll customize a connector to your specifications.

PART NUMBERS	DESCRIPTION	MODEL(S)
369-310	1.21 M / 1.41 F	JT520
369-470	1.21 M / 1.21 M	JT520
908-0804	1.21 M / #200 M	JT520
368-263	1.41 M / 1.94 M	JT920 / JT920L / JT921 / JT922 / JT9 / JT10
908-0806	1.41 M / 2.11 M	JT920 / JT920L / JT921 / JT922 / JT9 / JT10
908-0805	1.41 M / #200 M	JT920 / JT920L / JT921 / JT922 / JT9 / JT10
400-2220	1.41 M / 2.0 M API IF	JT920 / JT922 / JT9 / JT10
400-2222	2.0 F API IF / 1.94 M	JT920 / JT922 / JT9 / JT10
400-2221	2.0 F API IF / 1.41 F	JT920 / JT922 / JT9 / JT10
400-2223	2.0 M API IF / 1.94 F	JT920 / JT922 / JT9 / JT10
368-264	1.69 M / 1.94 M	JT1720M1
906-1783	1.69 F / 2.38 M API R	JT1720M1
908-1707	1.69 M / 2.38 M API R	JT1720M1
906-2562	1.69 M / 2.12 LPT M	JT1720M1
368-261	1.94 M / 1.94 M	JT1720M1 / JT2020 / JT20
369-139	1.94 M / 2.40 M	JT1720M1 / JT2020 / JT20
906-2582	1.94 M / 2.38 M API R	JT1720M1 / JT2020 / JT20
908-0818	1.94 F / 2.11 M	JT1720M1 / JT2020 / JT20
908-1703	1.94 F / 2.38 M API R	JT1720M1 / JT2020 / JT20
908-1708	1.94 M / 2.38 M API R	JT1720M1 / JT2020 / JT20
908-4189	1.94 M / 2.12 LPT F	JT1720M1 / JT2020 / JT20
908-4103	2.38 API R M / 2.12 LPT M	D16X20 / D24X33
400-2570	2.38 API R M / 2.38 API R M	JT1720 / JT2020 / JT20 / JT24 / JT25 / JT2720 / JT3020 / JT30 / D16X20 / D18X20 / D20X22 / D24X26 / D24X33 / D24X40 / D33X44 / D36X50 / JT40
400-1825	2.38 API R F / 2.88 API R M	JT1720 / JT2020 / JT20 / JT24 / JT25 / JT2720 / JT3020 / JT30 / D16X20 / D18X20 / D20X22 / D24X26 / D24X33 / D24X40 / D33X44 / D36X50 / JT40
400-2739	2.38 API R F / 3.5 API IF M	JT1720 / JT2020 / JT20 / JT24 / JT25 / JT2720 / JT3020 / JT30 / D16X20 / D18X20 / D20X22 / D24X26 / D24X33 / D24X40 / D33X44 / D36X50 / JT40
400-2571	2.88 API R M / 2.88 API R M	JT4020 / D24X26 / D24X40 / D36X50 / D50X100 / D55X10 / JT40
400-567	2.59 F / 2.40 M	JT4020
400-1676	2.59 F / 2.88 M API R	JT4020
400-568	2.59 F / 3.50 F API R	JT4020
400-576	2.59 F / 3.27 M	JT4020
908-4226	2.59 F / 2.38 M API R	JT4020
908-4004	2.38 F API R / 2.59 M	JT4020
400-035	3.5 IF M / 3.5 IF M	JT4020 / D24X26 / D24X40 / D36X50 / D50X100 / D55X10 / DD110 / JT40



QUICK CONNECT SYSTEMS





## CONNECTORS

PART NUMBERS	DESCRIPTION	MODEL(S)
400-016	2.88 M API IF / 2.88 M API R	AT4020
400-038	2.88 M API R / 2.38 M API IF	AT4020
400-040	2.88 M API R / 3.50 M API R	AT4020
400-3048	2.88 API R F / 3.5 API IF M	JT60
400-3049	3.5 F API IF / 2.88 M API R	JT60
400-2308	3.27 F / 2.88 M API R	JT60
400-2307	2.88 F API R / 3.27 M	JT60
400-2230	3.5 F API IF / 3.27 M	JT60 / JT7020 / JT8020 / JT100
401-255	3.27 F / 2.88 M API IF	JT7020 / JT8020 / JT100 / JT60 / AT60
401-256	3.27 F / 3.5 M API R	JT7020 / JT8020 / JT100 / JT60 / AT60
908-5188	3.27 F / 2.88 M API R	JT7020 / JT8020 / JT100
908-5196	3.27 F / 3.5 M API R	JT7020 / JT8020 / JT100
400-1675	3.27 F / 3.5 M API IF	JT7020 / JT8020 / JT100
400-035	3.5 M API IF / 3.5 M API IF	JT7020 / JT8020 / JT100
400-036	3.5 M API IF / 3.5 M API R	JT7020 / JT8020 / JT100
369-472	3.27 F / 3.5 F API R	JT60 / JT7020 / JT8020 / JT100 / AT60
369-257	1.31 F EZ2 / 1.21 M	JT520 / JT5
369-307	1.31 F EZ2 / 1.94 M	JT520 / JT5
369-309	1.31 F EZ2 / 5K Tab	JT520 / JT5
369-311	1.31 F EZ2 / 1.41 F	JT520 / JT5
400-1431	1.31 F EZ2 / 1.10 M	JT520 / JT5
908-0792	1.31 F EZ2 / #200 M	JT520 / JT5
400-064	1.63 F EZ2 / 1.41 F	JT920 / JT920L / JT921 / JT922 / JT9
400-2672	1.31 F EZ2 / 2.0 M	JT520 / JT5
400-068	1.63 F EZ2 / 1.94 M	JT920 / JT920L / JT921 / JT922 / JT9
908-0793	1.63 F EZ2 / 2.11 M	JT920 / JT920L / JT921 / JT922 / JT9
400-2218	1.63 F EZ2 / 2.0 M API IF	JT920 / JT920L / JT921 / JT922 / JT9
400-920	1.88 F EZ3 / 1.94 M	JT1220M1
401-006	1.88 F EZ3 / 1.94 F	JT1220M1
908-0808	1.88 F EZ3 / 2.11 M	JT1220M1
908-0816	1.88 F EZ3 / 2.38 M API R	JT1220M1
400-2188	1.88 F EZ3 / 2.0 M API IF	JT1220M1
369-999	2.0 F EZ / 1.94 M	JT1720M1 / JT2020 / JT20
400-615	2.0 F EZ2 / 1.94 F	JT1720M1 / JT2020 / JT20
400-824	2.0 F EZ2 / 2.59 M	JT1720M1 / JT2020 / JT20
400-2201	2.0 F EZ2 / 2.0 M API IF	JT1720M1 / JT2020 / JT20
908-1706	2.0 F EZ2 / 2.38 M API R	JT1720M1 / JT2020 / JT20
400-1050	2.25 F EZ3 / 1.94 M	JT1720M1 / JT2020 / JT20
400-1010	2.25 F EZ3 / 2.59 M	JT24 / JT25 / JT3020 / JT30
400-309	2.25 F EZ2 / 2.59 M	JT2720M1
401-340	2.25 F EZ2 / 2.4 M	JT2720M1
908-4235	2.25 F EZ2 / 2.38 M API R	JT24 / JT25 / JT3020 / JT30
908-4225	2.25 F EZ3 / 2.38 M API R	JT24 / JT25 / JT3020 / JT30



## CONNECTORS

PART NUMBERS	DESCRIPTION	MODEL(S)
400-091	2.63 F EZ2 / 3.27 M	JT4020 / JT40
400-1417	2.63 F EZ2 / 2.88 M API R	JT4020 / JT40
400-094	2.63 F EZ2 / 2.59 M	JT4020 / JT40
400-2392	2.85 6F EZ2 / 2.88 M API R	AT40 / JT60
400-2394	2.85 6F EZ2 / 3.50 M API IF	AT40 / JT60
400-2395	2.85 6F EZ2 / 3.27 M	AT40 / JT60
368-813	3.5 F EZ2 / 3.27 M	JT60 / JT7020 / JT8020 / JT100
400-1480	3.5 F EZ / 3.50 M API IF	JT7020 / JT8020 / JT100
400-2277	3.5-F EZ / 2.88 M API R	JT60
368-813	3.5-F EZ / 3.27 M	JT60
908-0817	#200 F / 2.11 M	JT520 / JT5 / JT922 / D6X6 / D7X11 / D9X13
908-0701	#200 M / 2.0 M API IF	JT520 / JT5 / JT922 / D6X6 / D7X11 / DX913
908-1701	#250 F / 2.38 M API R	JT1220 / D16X20
908-1724	#400 M / 2.0 M API IF	JT1220 / JT2020 / D18X20 / D20X22 / D24X26
908-1725	#400 M / 2.38 M API R	JT1220 / JT2020 / D18X20 / D20X22 / D24X26
908-1726	#400 M / 1.94 M	JT1220 / JT2020 / D18X20 / D20X22 / D24X26
908-1704	#400 F / 2.38 M API R	JT1220 / JT2020 / JT20 / D18X20 / D20X22 / D24X26
908-4228	#402 F / 2.38 M API R	D24X33
908-4196	#600 F / 2.88 M API R	JT2020 / JT20 / JT24 / JT25 / JT3020 / JT30 / D24X40
908-4224	#600 F / 2.38 M API R	JT2020 / JT20 / JT24 / JT25 / JT3020 / JT30 / D24X40
908-1727	#600 M / 1.94 M	JT2020 / JT20 / JT24 / JT25 / JT3020 / JT30 / D24X40
908-4002	#600 M / 2.38 M API R	JT2020 / JT20 / JT24 / JT25 / JT3020 / JT30 / D24X40
908-4003	#600 M / 2.59 M	JT2020 / JT20 / JT24 / JT25 / JT3020 / JT30 / D24X40
908-4197	#602 F / 2.88 M API R	D33X34 / D36X50
908-4233	#602 F / 2.38 M API R	D33X34 / D36X50
908-4234	#650 F / 2.38 M API R	D33X34 / D36X50
908-4242	#700 F / 2.38 M API R	D36X50
908-5199	#800 F / 3.50 M API R	JT7020 / JT8020 / JT100 / D80X100
908-5210	#800 F / 3.50 M API IF	JT7020 / JT8020 / JT100 / D80X100
908-5002	#800 M / 2.88 M API R	JT7020 / JT8020 / JT100 / D80X100
908-5186	#800 F / 2.88 M API R	JT100
908-5004	#800 M / 3.5 M API IF	JT7020 / JT8020 / JT100 / D80X100
908-5005	#800 M / 3.27 M	JT7020 / JT8020 / JT100 / D80X100
908-5205	#802 F / 3.50 M API R	D80X120 / D100X120 / DD110
908-5211	#802 F / 3.50 M API IF	D80X120 / D100X120 / DD110
908-5195	#802 F / 2.88 M API R	D80X120 / D100X120 / DD110
908-5184	#900 F / 2.88 M API R	D50X100 / D80X100
908-5200	#900 F / 3.50 M API R	JT60 / D50X100 / D80X100
908-5214	#900 F / 3.50 M API IF	JT60 / D50X100 / D80X100
908-5190	#1000 F / 2.88 M API R	D80X120 / D100X120 / DD110
908-5207	#1000 F / 3.50 M API R	D80X120 / D100X120 / DD110
908-5213	#1000 F / 3.50 M API IF	D80X120 / D100X120 / DD110



# CONNECTORS

PART NUMBERS	DESCRIPTION	MODEL(S)
918-0749	Hawkeye® 275 M / 1.41 F	JT9 / JT920 / JT920L / JT921 / JT922 / JT10 / JT1220 / D6X6 / D7X11 / D9X13
918-0747	Hawkeye 275 M / 1.94 M	JT9 / JT920 / JT920L / JT921 / JT922 / JT10 / JT1220 / D6X6 / D7X11 / D9X13
918-0751	Hawkeye 275 M / 2.0 M API IF	JT9 / JT920 / JT920L / JT921 / JT922 / JT10 / JT1220 / D6X6 / D7X11 / D9X13
918-0745	Hawkeye 275 M / 2.11 M	JT9 / JT920 / JT920L / JT921 / JT922 / JT10 / JT1220 / D6X6 / D7X11 / D9X13
918-0707	Hawkeye 275 M / 2.38 M API R	JT9 / JT920 / JT920L / JT921 / JT922 / JT10 / JT1220 / D6X6 / D7X11 / D9X13
918-0731	Hawkeye 275 M / SplineLok® II 350 M	JT9 / JT920 / JT920L / JT921 / JT922 / JT10 / JT1220 / D6X6 / D7X11 / D9X13
918-0729	Hawkeye 275 M / 1.62 LPT F	JT9 / JT920 / JT920L / JT921 / JT922 / JT10 / JT1220 / D6X6 / D7X11 / D9X13
918-0730	Hawkeye 275 M / 2.125 LPT F	JT9 / JT920 / JT920L / JT921 / JT922 / JT10 / JT1220 / D6X6 / D7X11 / D9X13
918-2451	Hawkeye 350 M / 1.94 M	JT1720 / JT2020 / JT20 / D16X20 / D18X20 / D20X22
918-2407	Hawkeye 350 M / 2.38 M API R	JT1720 / JT2020 / JT20 / JT24 / JT25 / JT2720 / JT3020 / JT30 / D16X20 / D18X20 / D20X22 / D24X26 / D24X33 / D24X40 / D33X44 / D36X50
918-2452	Hawkeye 350 M / 2.59 M	JT24 / JT25 / JT2720 / JT3020 / JT30 / D24X26 / D24X33 / D24X40 / D33X44 / D36X50
918-2481	Hawkeye 350 M / 2.88 M API R	JT24 / JT25 / JT2720 / JT3020 / JT30 / D24X26 / D24X33 / D24X40 / D33X44 / D36X50
918-2483	Hawkeye 350 M / 2.0 M API IF	JT1220 / JT2020 / JT20 / JT24
918-2429	Hawkeye 350 M / SplineLok II 350 M	JT1720 / JT2020 / JT20 / JT24 / JT25 / JT2720 / JT3020 / JT30 / D16X20 / D18X20 / D20X22 / D24X26 / D24X33 / D24X40 / D33X44 / D36X50
918-2479	Hawkeye 350 M / #800 M	JT7020 / JT8020 / JT100 / D80X100
918-2426	Hawkeye 350 M / 2.125 LPT F	D16X20 / D18X20 / D20X22 / D24X26 / D24X33 / D24X40 / D33X44 / D36X50
918-2428	Hawkeye 350 M / 1.625 LPT F	D6X6 / D7X11 / D9X13
918-3052	Hawkeye 390 M / 1.94 M	JT1720 / JT2020 / JT20 / D16X20 / D18X20 / D20X22
918-3044	Hawkeye 390 M / 2.59 M	JT24 / JT25 / JT2720 / JT3020 / JT30 / JT4020 / D24X26 / D24X33 / D24X40 / D33X44 / D36X50 / JT40
918-3024	Hawkeye 390 M / 2.38 M API R	JT1720 / JT2020 / JT20 / JT24 / JT25 / JT2720 / JT3020 / JT30 / D16X20 / D18X20 / D20X22 / D24X26 / D24X33 / D24X40 / D33X44 / D36X50
918-3006	Hawkeye 390 M / 2.88 M API R	JT4020 / D24X26 / D24X40 / D36X50 / D50X100 / D55X10 / JT40
918-3035	Hawkeye 390 M / SplineLok II 350 M	JT1720 / JT2020 / JT20 / JT25 / JT2720 / JT3020 / JT30 / D16X20 / D18X20 / D20X22 / D24X26 / D24X33 / D24X40 / D33X44 / D36X50 / JT40
918-3069	Hawkeye 390 M / #800 M	JT4020 / D24X26 / D24X40 / D36X50 / D50X100 / D55X10 / JT40
918-3071	Hawkeye 390 M / 3.27 M	JT4020 / D24X26 / D24X40 / D36X50 / D50X100 / D55X10 / JT40
918-3033	Hawkeye 390 M / 1.625 LPT F	D6X6 / D7X11 / D9X13
918-3034	Hawkeye 390 M / 2.12 LPT F	D16X20 / D18X20 / D20X22 / D24X26 / D24X33 / D24X40 / D33X44 / D36X50
918-3624	Hawkeye 426 M / 2.38 M API R	JT1720 / JT2020 / JT20 / JT24 / JT25 / JT2720 / JT3020 / JT30 / D16X20 / D18X20 / D20X22 / D24X26 / D24X33 / D24X40 / D33X44 / D36X50
918-3647	Hawkeye 426 M / 2.59 M	JT24 / JT25 / JT2720 / JT3020 / JT30 / JT4020 / D24X26 / D24X33 / D24X40 / D33X44 / D36X50 / JT40
918-3606	Hawkeye 426 M / 2.88 M API R	JT4020 / D24X26 / D24X40 / D36X50 / D50X100 / D55X10 / JT40
918-3607	Hawkeye 426 M / 3.5 M API R	JT4020 / D24X26 / D24X40 / D36X50 / D50X100 / D55X10 / JT40
918-3629	Hawkeye 426 M / #900 M	JT4020 / D24X26 / D24X40 / D36X50 / D50X100 / D55X10 / JT40
918-3622	Hawkeye 426 M / #800 M	JT4020 / D24X26 / D24X40 / D36X50 / D50X100 / D55X10 / JT40

# CONNECTORS

PART NUMBERS	DESCRIPTION	MODEL(S)
918-3634	Hawkeye® 426 M / 2.12 LPT F	D16X20 / D18X20 / D20X22 / D24X26 / D24X33 / D24X40 / D33X44 / D36X50
908-4268	SplineLok® II 350 F / 1.94 M	JT1720 / JT2020 / JT20
908-4124	SplineLok II 350 F / #600 F	JT2020 / JT20 / JT24 / JT25 / JT3020 / JT30 / D24X40
908-4123	SplineLok II 350 F / #600 M	JT2020 / JT20 / JT24 / JT25 / JT3020 / JT30 / D24X40
908-4269	SplineLok II 350 F / 2.59 M	JT4020 / JT40
908-4153	SplineLok II 350 M / 2.38 F API R	JT1720 / JT2020 / JT20 / JT24 / JT25 / JT2720 / JT3020 / JT30 / D16X20 / D18X20 / D20X22 / D24X26 / D24X33 / D24X40 / D33X44 / D36X50
908-4137	SplineLok II 350 F / #800 F	JT4020 / D24X26 / D24X40 / D36X50 / D50X100 / D55X10 / JT40
908-4180	SplineLok II 350 F / 3.5 M API R	JT4020 / D24X26 / D24X40 / D36X50 / D50X100 / D55X10 / JT40
908-4188	SplineLok II 350 F / #800 M	JT4020 / D24X26 / D24X40 / D36X50 / D50X100 / D55X10 / JT40
908-4021*	SplineLok II 350 F / 2.12 LPT WELD-OVER	D16X20 / D18X20 / D20X22 / D24X26 / D24X33 / D24X40 / D33X44 / D36X50
908-4171	SplineLok II 350 F / #900 M	JT4020 / D24X26 / D24X40 / D36X50 / D50X100 / D55X10 / JT40
908-4149	SplineLok II 350 F / 2.88 M API R	JT4020 / D24X26 / D24X40 / D36X50 / D50X100 / D55X10 / JT40
908-4102	SplineLok II 350 F / 2.38 M API R	JT1720 / JT2020 / JT20 / JT24 / JT25 / JT2720 / JT3020 / JT30 / D16X20 / D18X20 / D20X22 / D24X26 / D24X33 / D24X40 / D33X44 / D36X50
400-740	1.62 LPT M / 1.41 F	D6X6 / D7X11 / D9X13
400-742	1.62 LPT F / 1.94 M	D6X6 / D7X11 / D9X13
400-743	1.62 LPT M / 1.94 M	D6X6 / D7X11 / D9X13
908-0825	1.62 LPT M / 2.0 M API IF	D6X6 / D7X11 / D9X13
918-0728	1.62 LPT F / 2.38 F API R	D6X6 / D7X11 / D9X13
908-0790	1.62 LPT M / 2.38 M API R	D6X6 / D7X11 / D9X13
908-0815	1.62 LPT M / 2.11 M	D6X6 / D7X11 / D9X13
400-140	2.12 LPT / 1.94 M	D16X20 / D18X20 / D20X22 / D24X26 / D24X33
908-4007	2.12 LPT M / 2.0 M API IF	D6X6 / D7X11 / D9X13
918-3632	2.12 LPT F / 2.38 API R F	D24X33 / D24X40 / D33X44 / D36X50
908-1666	2.12 LPT M / 2.38 API R M	D16X20 / D18X20 / D20X22 / D24X26 / D24X33
908-4142	2.12 LPT M / 350 SPL II M	D16X20 / D18X20 / D20X22 / D24X26 / D24X33 / D24X40 / D33X44 / D36X50

\* Weld-on connector to convert 2.12 LPT to SplineLok II 350 F.



QUICK CONNECT SYSTEMS



# STRONG CONNECTIONS. SUPERIOR PROTECTION.



When it comes to protecting your electronics, Ditch Witch® HDD Tooling continues to offer innovative solutions. In our PowerHouse® HD housings, our industry-exclusive Beacon Buddy helps protect your electronics from overheating. We offer Ditch Witch and competitive bolt patterns and accommodate Subsite® Electronics and competitive electronics.

## POWERHOUSE® HD DIRT HOUSINGS

PowerHouse HD Dirt housings are the most advanced, durable and productive housings on the market today. They are exceptionally strong and offer extended battery life and electronic protection with a Beacon Buddy to prevent overheating. Every PowerHouse HD Dirt housing is designed to deliver increased uptime and more profit per foot.

PART NUMBERS	DIAMETER	BIT PATTERN / THREAD	ELECTRONICS	NOZZLE(S)	MODEL(S)
908-0680	2"	3 Hole / 12 mm / DW / 1.1	SBRP / 88B	1	JT5 / JT520
908-0880	2.5"	5 Hole / 12 mm / DW / 2.0 API IF	15T / 17T	1	JT9 / JT922 / JT921 / JT921S / JT920 / JT920L
908-1080	2.75"	5 Hole / 12 mm / DW / 2.0 API IF	15T / 17T	1	JT1220
908-1680	3"	5 Hole / 12 mm / DW / 2.38 API R	15T / 17T	1	JT20 / JT2020M1
908-4080	3.25"	6 Hole / 16 mm / DW / 2.38 API R	15T / 17T	2	JT25 / JT30 / JT3020M1 / JT2720M1
908-4082	3.75"	6 Hole / 20 mm / DW / 2.88 API R	15T / 17T	2	JT4020M1 / JT40
908-5280	4.25"	6 Hole / 20 mm / DW / 2.88 API R	15T / 17T	2	JT4020M1 / JT40 / JT60
400-3018	4.75"	6 Hole / 20 mm / DW / 3.5 API IF	15T / 17T / 19T	3	JT100 / DD110
906-5357*	4.75"	6 Hole / 20 mm / DW / 3.5 API IF	BHL Series	2	JT100 [TriHawk® Assembly 906-5356, 906-5296] / DD110
400-1423*	4.75"	6 Hole / 20 mm / DW / 3.5 API IF	BHL Series	2	JT100 / DD110
908-0670	2"	5 Hole / 3/8" / VM / Firestick® I #200	DCI® Mini	1	D6X6 / D7X11 / D9X13
908-0870**	2.5"	6 Hole / 1/2" / VM / 2.0 API IF	15T / 17T	1	D6X6 / D7X11 / D9X13
908-1070**	2.75"	6 Hole / 1/2" / VM / 2.0 API IF	15T / 17T	1	D6X6 / D7X11 / D9X13
908-1670**	3"	6 Hole / 1/2" / VM / 2.38 API R	15T / 17T	1	D16X20 / D18X20 / D20X22
908-4070**	3.25"	6 Hole / 1/2" / VM / 2.38 API R	15T / 17T	2	D24X26 / D24X33 / D24X40 / D33X44 / D36X50
908-5270**	4.25"	6 Hole / 5/8" / VM / 2.88 API R	15T / 17T	2	D50X100 / D55X100 / D75X100 / D80X100 / D80X120 / D100X120
908-5272**	4.25"	6 Hole / 3/4" / VM / 2.88 API R	15T / 17T	2	D50X100 / D55X100 / D75X100 / D80X100 / D80X120 / D100X120
159-461		Housing	Beacon Buddy - 8		Up to 3"
159-473		Housing	Beacon Buddy - 12		3.25" and up

\* Not a Single Pin Housing. \*\* These housings will accommodate DCI® Electronics with included isolation.

## HOUSING ACCESSORIES

DIAMETER	HOUSING	LID PIN	COIL PIN	LID BOLT	BIT BOLT
2	908-0680		911-2450	908-0671	107-277
2.5	908-0880	908-0852	906-2405	908-0833	107-277
2.75	908-1080	908-0852	906-2405	908-0833	107-277
3	908-1680	906-2652	906-2405	906-2633	107-277
3.25	908-4080	906-2652	906-2405	906-2633	106-681
3.75	908-4082	906-2652	906-2405	906-2633	107-284
4.25	908-5280	906-2652	906-2405	906-2633	107-284
4.75	906-5357	906-2652	906-2405	906-2633	107-284
2	908-0670		911-2450	908-0671	105-1743
2.5	908-0870	908-0852	906-2405	908-0833	105-910
2.75	908-1070	908-0852	906-2405	908-0833	105-910
3	908-1670	906-2652	906-2405	906-2633	105-910
3.25	908-4070	906-2652	906-2405	906-2633	105-910
4.25	908-5270	906-2652	906-2405	906-2633	105-1744
4.25	908-5272	906-2652	906-2405	906-2633	105-1745





SOIL CONDITION CHART

KEY ●=Best ○=Better ○=Good

# DURABIT

The Durabit is designed to provide extended wear in all non-rock soil formations.

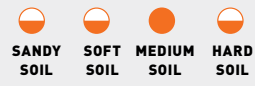

PART NUMBERS	CUT	BOLT PATTERN	BOLT SIZE	THICKNESS	BEND ANGLE
369-169*	2.5" / 63.5 mm	3 Hole DW	12 mm	1/2"	0°
368-901	3" / 76.2 mm	5 Hole DW	12 mm	5/8"	10°
368-900	3" / 76.2 mm	5 Hole DW	12 mm	1/2"	10°
368-899	3" / 76.2 mm	5 Hole DW	12 mm	5/8"	0°
368-898	3" / 76.2 mm	5 Hole DW	12 mm	1/2"	0°
368-904	4" / 101.6 mm	5 Hole DW	12 mm	3/4"	10°
368-903	4" / 101.6 mm	5 Hole DW	12 mm	5/8"	10°
368-902	4" / 101.6 mm	5 Hole DW	12 mm	1/2"	10°
369-082	5" / 127 mm	5 Hole DW	12 mm	5/8"	10°
369-005	5" / 127 mm	6 Hole DW	16 mm	3/4"	0°
368-980	5.2" / 132.08 mm	6 Hole DW	20 mm	1"	0°
368-982	6.4" / 162.56 mm	6 Hole DW	20 mm	1"	0°
368-984	8" / 203.2 mm	6 Hole DW	20 mm	1"	0°
400-1869	2.5" / 63.5 mm	5 Hole VM	3/8"	1/2"	0°

\*See page 75 for bit clevis 369-709.



# STEEP TAPER BIT

Designed with a pointed, triangle-shaped nose, the Steep Taper Bit can be used in highly compacted soil and cobble.

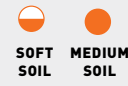

PART NUMBERS	CUT	BOLT PATTERN	BOLT SIZE	THICKNESS	BEND ANGLE
369-315*	2.5" / 63.5 mm	3 Hole DW	12 mm	1/2"	0°
369-072	3" / 76.2 mm	5 Hole DW	12 mm	5/8"	10°
368-895	4" / 101.6 mm	5 Hole DW	12 mm	5/8"	10°
369-074	5" / 127 mm	5 Hole DW	12 mm	5/8"	10°
400-170**	4.5" / 114.3 mm	6 Hole DW	16 mm	3/4"	10°
369-183	5" / 127 mm	6 Hole DW	16 mm	3/4"	0°
369-466	5" / 127 mm	6 Hole DW	16 mm	3/4"	10°
369-467	6.4" / 162.56 mm	6 Hole DW	16 mm	3/4"	10°
369-486	5" / 127 mm	6 Hole DW	20 mm	1"	0°
369-490	6.4" / 162.56 mm	6 Hole DW	20 mm	1"	0°
400-1851	3.5" / 88.9 mm	6 Hole VM	1/2"	1"	10°
400-1841	4" / 101.6 mm	6 Hole VM	1/2"	3/4"	10°
400-1843	5" / 127 mm	6 Hole VM	1/2"	1"	10°
400-1845	6.5" / 165.1 mm	6 Hole VM	1/2"	1"	10°
400-1847	5" / 127 mm	6 Hole VM	5/8"	1"	10°
400-1849	6" / 125.4 mm	6 Hole VM	5/8"	1"	10°
400-1915	8" / 203.2 mm	6 Hole VM	3/4"	1"	10°

See page 75 for:

\*bit clevis 369-709, \*\*bit pull eye assembly 400-242.



Vermeer® Compatible

# STEEP TAPER TUFF BIT

Designed for hard, compacted soils and cobble and chunk rock formations, the Steep Taper Tuff Bit features a pointed, triangle-shaped nose and Tuff Bit segments along the leading edge that have the strength and stability to withstand the pounding and vibration of drilling in rock.

PART NUMBERS	CUT	BOLT PATTERN	BOLT SIZE	THICKNESS	BEND ANGLE
400-120	4" / 101.6 mm	5 Hole DW	12 mm	3/4"	10°
400-122	4" / 101.6 mm	6 Hole DW	16 mm	3/4"	10°
400-124	5" / 127 mm	6 Hole DW	16 mm	3/4"	10°
400-1893	5" / 127 mm	6 Hole DW	20 mm	1"	10°
400-431	6" / 152.4 mm	6 Hole DW	20 mm	1"	10°
400-1895	8" / 203.2 mm	6 Hole DW	20 mm	1"	10°
400-1530	4" / 101.6 mm	6 Hole VM	1/2"	3/4"	10°
400-1885	3.5" / 88.9 mm	6 Hole VM	1/2"	5/8"	10°
400-1532	5" / 127 mm	6 Hole VM	1/2"	3/4"	10°
400-1887	5" / 127 mm	6 Hole VM	5/8"	1"	10°
400-1889	6" / 152.4 mm	6 Hole VM	5/8"	1"	10°
400-1891	8" / 203.2 mm	6 Hole VM	3/4"	1"	10°
400-2659***	4" / 101.6 mm	6 Hole DW	16 mm	3/4"	10°
400-2657***	4" / 101.6 mm	5 Hole DW	12 mm	3/4"	10°
400-2661***	5" / 127 mm	6 Hole DW	16 mm	3/4"	10°
400-2665***	4" / 101.6 mm	6 Hole VM	1/2"	3/4"	10°
400-2663***	3.5" / 88.9 mm	6 Hole VM	1/2"	5/8"	10°
400-2667***	5" / 127 mm	6 Hole VM	1/2"	3/4"	10°



\*\*\*See page 75 for pull tool 400-2669.

Note: See page 75 for pull tool shackles.



Vermeer® Compatible

400-2669



SOIL CONDITION CHART KEY ●=Best ○=Better ○=Good

## OMNI BIT™



Take on a wider range of soil conditions with one bit—the Omni Bit. Built to tackle any terrain, the Omni Bit features a new, forward-facing cutting structure that eliminates the blunt nose for more productive drilling in the widest range of soils. The contour design allows for a larger pull hole to accommodate bigger shackles and maximize pulling capabilities. Also redesigned, the carbide teeth are more rounded—a Ditch Witch® exclusive—and less susceptible to fracture, improving bit longevity, durability and productivity.

PART NUMBERS	DESCRIPTION	WIDTH	BOLT PATTERN	BOLT SIZE	THICKNESS
400-2749	3-3 / 12-50-10 Omni Bit	3" / 76.2 mm	3 Hole DW	12 mm	.5"
400-2751	3.5-5 / 12-75-10 Omni Bit	3.5" / 88.9 mm	5 Hole DW	12 mm	.75"
400-2753	4-5 / 12-75-10 Omni Bit	4" / 101.6 mm	5 Hole DW	12 mm	.75"
400-2755	4.5-5 / 12-75-10 Omni Bit	4.5" / 114.3 mm	5 Hole DW	12 mm	.75"
400-2757	4-6 / 16-75-10 Omni Bit	4" / 101.6 mm	6 Hole DW	16 mm	.75"
400-2759	4.5-6 / 16-75-10 Omni Bit	4.5" / 114.3 mm	6 Hole DW	16 mm	.75"
400-2761	5-6 / 16-75-10 Omni Bit	5" / 127 mm	6 Hole DW	16 mm	.75"
400-2763	6-6 / 20-1-10 Omni Bit	6" / 152.4 mm	6 Hole DW	20 mm	1"
400-2765	7-6 / 20-1-10 Omni Bit	7" / 177.8 mm	6 Hole DW	20 mm	1"
<b>VERMEER®</b>					
400-3092	4-6 / .5-75-10 Omni Bit	4" / 101.6 mm	6 Hole VM	12.7 mm	.75"
400-3123	5-6 / .5-75-10 Omni Bit	5" / 127 mm	6 Hole VM	12.7 mm	.75"
400-3125	5-6 / .625-75-10 Omni Bit	5" / 127 mm	6 Hole VM	12.7 mm	.75"



## TORNADO BIT

This long-lasting, all-purpose bit is designed for use in a variety of soils, including sandstone, chunk rock and hard soils. Tornado Bits use both button and crushed carbide for optimized performance and extended life.

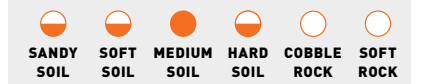

PART NUMBERS	CUT	BOLT PATTERN	BOLT SIZE	THICKNESS	BEND ANGLE
400-1929	3" / 76.2 mm	5 Hole DW	12 mm	5/8"	10°
400-1925	3.5" / 88.9 mm	5 Hole DW	12 mm	5/8"	10°
400-1927	4" / 101.6 mm	5 Hole DW	12 mm	5/8"	10°
400-1931	4" / 101.6 mm	5 Hole DW	12 mm	3/4"	10°
400-1585	5" / 127 mm	5 Hole DW	12 mm	3/4"	10°
400-1933	4.5" / 114.3 mm	6 Hole DW	16 mm	3/4"	10°
400-1935	5" / 127 mm	6 Hole DW	16 mm	3/4"	10°
400-1063	6" / 125.4 mm	6 Hole DW	16 mm	3/4"	10°
400-1937	6.5" / 165.1 mm	6 Hole DW	16 mm	3/4"	10°
400-1939	5" / 127 mm	6 Hole DW	20 mm	1"	10°
400-1941	6" / 125.4 mm	6 Hole DW	20 mm	1"	10°
400-1901	8" / 203.2 mm	6 Hole DW	20 mm	1"	10°
400-1897	3.5" / 88.9 mm	6 Hole VM	1/2"	5/8"	10°
400-1514	3.5" / 88.9 mm	6 Hole VM	1/2"	3/4"	10°
400-1516	4" / 101.6 mm	6 Hole VM	1/2"	3/4"	10°
400-1518	5" / 127 mm	6 Hole VM	1/2"	1"	10°
400-1520	6" / 125.4 mm	6 Hole VM	1/2"	3/4"	10°
400-1554	5" / 127 mm	6 Hole VM	5/8"	1"	10°
400-1558	6" / 125.4 mm	6 Hole VM	5/8"	1"	10°
400-1899	8" / 203.2 mm	6 Hole VM	3/4"	1"	10°



Vermeer® Compatible





### SOIL CONDITION CHART

KEY ● =Best ○ =Better ○ =Good

## TUFF BIT

The ultimate long-wearing bit for all soil conditions, including hard, compacted soils or soft, sedimentary rock. Tuff Bit segments along the leading edge have the strength and stability to handle the pounding and vibration of drilling in rock. The barracuda material down the sides reduces wear on the nose of the housing.

PART NUMBERS	CUT	BOLT PATTERN	BOLT SIZE	THICKNESS	BEND ANGLE
400-2963*	3" / 76.2 mm	3 Hole DW	12 mm	1/2"	10°
369-727**	3" / 76.2 mm	3 Hole DW	12 mm	1/2"	0°
369-729	3" / 76.2 mm	5 Hole DW	12 mm	5/8"	10°
401-334	3.5" / 88.9 mm	5 Hole DW	12 mm	5/8"	10°
369-731	4" / 101.6 mm	5 Hole DW	12 mm	5/8"	10°
369-733	5" / 127 mm	5 Hole DW	12 mm	5/8"	10°
400-172***	4.5" / 114.3 mm	6 Hole DW	16 mm	3/4"	10°
369-735	5" / 127 mm	6 Hole DW	16 mm	3/4"	10°
369-737	6.4" / 162.56 mm	6 Hole DW	16 mm	3/4"	10°
369-739	5" / 127 mm	6 Hole DW	20 mm	1"	10°
369-741	6.5" / 165.1 mm	6 Hole DW	20 mm	1"	10°
369-743	8" / 203.2 mm	6 Hole DW	20 mm	1"	10°
400-1871	2.5" / 63.5 mm	5 Hole VM	3/8"	1/2"	0°
400-1877	3.5" / 88.9 mm	6 Hole VM	1/2"	5/8"	10°
400-1522	4" / 101.6 mm	6 Hole VM	1/2"	3/4"	10°
400-1524	5" / 127 mm	6 Hole VM	1/2"	3/4"	10°
400-1881	5" / 127 mm	6 Hole VM	5/8"	1"	10°
400-1528	8" / 203.2 mm	6 Hole VM	5/8"	1"	10°
400-1560	6" / 152.4 mm	6 Hole VM	5/8"	1"	10°
400-1526	6.5" / 165.1 mm	6 Hole VM	1/2"	3/4"	10°
400-1879	8" / 203.2 mm	6 Hole VM	3/4"	1"	10°

See page 75 for: \*\*bit clevis 369-709, \*\*\*bit pulley assembly 400-242, \*pull tool 400-2669.



## SHOT GUN BIT



This new designed bit is made for hard compacted soils and sedimentary rock. The Shot Gun Bit uses large carbide cutters for greater rock fracturing and production. The barracuda material down the sides adds protection for the life of the bit.

PART NUMBERS	CUT	BOLT PATTERN	BOLT SIZE	THICKNESS	BEND ANGLE
400-1665	3.5" / 88.9 mm	5 Hole DW	12 mm	3/4"	10°
400-1667	4" / 101.6 mm	5 Hole DW	12 mm	3/4"	10°
400-1669	5" / 127 mm	5 Hole DW	12 mm	3/4"	10°
400-1671	4" / 101.6 mm	6 Hole DW	16 mm	1"	10°
400-1673	5" / 127 mm	6 Hole DW	16 mm	1"	10°
400-1905	5" / 127 mm	6 Hole DW	16 mm	3/4"	10°
400-1907	6" / 152.4 mm	6 Hole DW	20 mm	1"	10°
400-1909	8" / 103.2 mm	6 Hole DW	20 mm	1"	10°
400-1574	3.5" / 88.9 mm	6 Hole VM	1/2"	3/4"	10°
400-1576	4" / 101.6 mm	6 Hole VM	1/2"	3/4"	10°
400-1578	5" / 127 mm	6 Hole VM	1/2"	3/4"	10°
400-1580	5" / 127 mm	6 Hole VM	5/8"	1"	10°
400-1582	6" / 152.4 mm	6 Hole VM	5/8"	1"	10°
400-1903	8" / 203.2 mm	6 Hole VM	3/4"	1"	10°



Vermeer®  
Compatible







# TRIED. TRUE. TRIHAWK.

The Ditch Witch® TriHawk housing is an exceptionally versatile, durable and productive housing for directional drilling. But best of all, it's rebuildable. So no matter what your particular drilling application or jobsite conditions, Ditch Witch electronic housings are easy to use. **We're In This Together.**

CHECK VALVE PREVENTS CUTTINGS IN THE HOUSING

STRATEGIC CUTAWAY AND SIGNAL SLOTS EXTEND ELECTRONICS' BATTERY LIFE

HIGH FLOW AND DURABLE FOR VARYING SOIL CONDITIONS

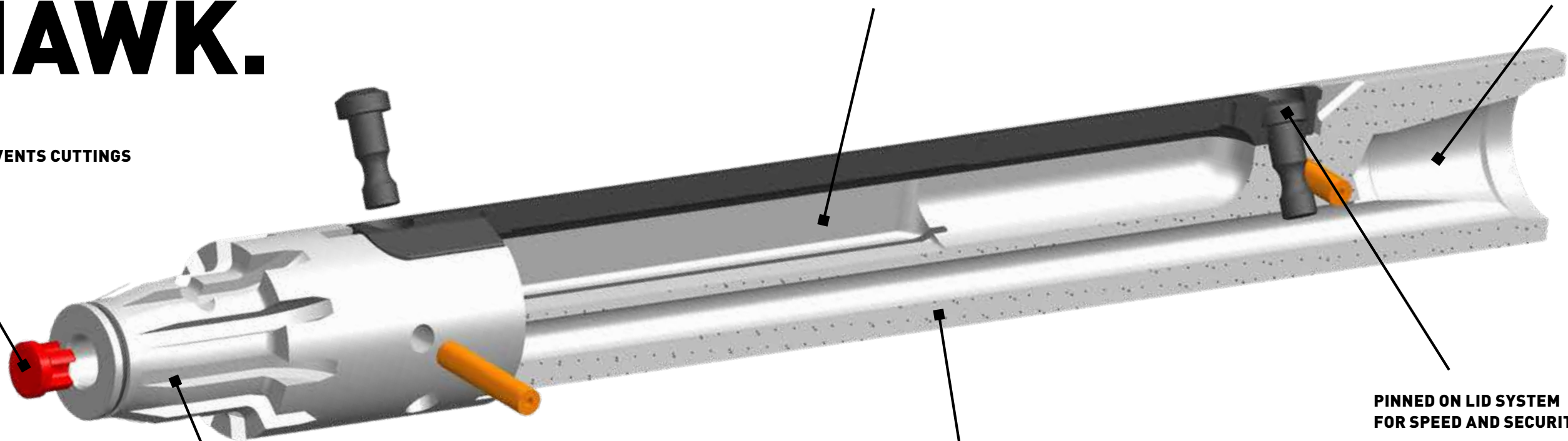

PINNED ON LID SYSTEM FOR SPEED AND SECURITY

SQUARE SPLINE PROVIDES BEST TORQUE TRANSFER AND RAPID BIT CHANGEABILITY

ALL DITCH WITCH HOUSINGS HAVE PROPER BIT TO DOOR ALIGNMENT FOR ADDED STRENGTH AND SECURITY (THIS IS AN ILLUSTRATION ONLY)

## AVAILABLE BITS:



TRIHAWK I



TRIHAWK I HD



TRIHAWK III



TRIHAWK IV



TRIHAWK V



TRIHAWK REAMER BIT



DIRT BIT ADAPTERS





# DRILLING CONDITIONS CHANGE. PERFORMANCE DOESN'T.



With their innovative, high-flow design and exceptional versatility, the TriHawk HD housings are the best choice for your lineup, and the best choice for varying soil conditions. Plus, you can change tooling with maximum speed and security thanks to its square drive spline. Just one of the TriHawk HD housing's many patented features.

## TRIHAWK® HD HOUSINGS

TriHawk HD housings are exceptionally versatile, durable and productive housings that are compatible with Ditch Witch® and Vermeer® drills. With their innovative high-flow design, TriHawk HD housings have the power and volume to drill in varying ground conditions. Plus, as drilling conditions change, you can change tooling with maximum speed and security thanks to a square drive spline, one of the TriHawk HD housing's many patented features.

PART NUMBERS	DIAMETER	THREAD	SPLINE SIZE	ELECTRONICS	MODEL(S)
906-0854	2.75"	2.0 API IF	2.125"	15T / 17T	JT9 / JT922 / JT1220 / D6X6 / D7X11 / D9X13
906-1854	3"	2.38 API R	2.125"	15T / 17T	JT1220 / JT1720M1 / JT20 / JT2020 / D6X6 / D7X11 / D9X13 / D16X20 / D18X20 / D20X22
906-2654	3.5"	2.38 API R	2.5"	15T / 17T	JT25 / JT2720M1 / JT30 / JT3020 / JT4020 / D24X26 / D24X33 / D24X40 / D33X44 / D36X50
906-2754	3.75"	2.88 R	2.5"	15T / 17T	JT40
906-5354	4.25"	2.88 API R	3.375"	15T / 17T	JT4020 / JT7020 / JT8020 / JT60 / D33X44 / D36X50 / D50X100 / D55X100 / D75X100 / D80X100 / D80X120
906-5356	4.75"	3.5 API IF	3.375"	906-5356 BHL Only	JT7020M1 / JT8020M1 / JT100 / D50X100 / D55X100 / D75X100 / D80X100 / D80X120 / DD110

## HOUSING ACCESSORIES

DIAMETER	HOUSING	LID	LID PIN	COIL PIN	FLOW CHECK	O-RING
2.75	906-0854	908-0835	908-0852	906-2405	906-2638	906-1604
3	906-1854	908-0835	908-0852	906-2405	906-2638	906-1604
3.5	906-2654	906-2635	906-2652	906-2405	906-2638	906-2404
3.75	906-2754	906-2635	906-2652	906-2405	906-2638	906-2404
4.25	906-5354	906-2635	906-2652	908-0019	906-2638	906-5004
4.75	906-5356	906-5335	906-2652	908-0019	906-2638	906-5004





SOIL CONDITION CHART KEY ●=Best ○=Better ○=Good

TriHawk bits are field-proven to provide unbeatable performance and reliability. Using the highest-quality, heat-treated alloy steel and strategically placed carbide, TriHawk bits punch through rock, overburdened cobble or compacted soil, while their patented square-drive spline is the toughest tooling connection in the industry. Combine them with TriHawk HD housings for an unbeatable combination.

## TRIHAWK I

TriHawk I is an aggressive directional drill bit designed for soft rock conditions. It also provides excellent performance in dry, compacted soils as well as cobble and broken formations. Made of high-quality, heat-treated alloy steel, TriHawk I features replaceable carbide teeth that are angled into the cut to increase production and reduce machine vibration.



PART NUMBERS	CUT	SPLINE	REPLACEMENT TEETH	DRILL SIZE
906-1792	3.75" / 95.25 mm	2.125"	906-1642 short / 906-1637 long	6K - 12K Drills
906-1626	4.44" / 112.77 mm	2.125"	906-2434 short / 906-2437 long	16K - 20K Drills
906-1627 HD	4.5" / 114.3 mm	2.125		16K - 20K Drills
906-2426	5.12" / 130.04 mm	2.5"	906-2446 med / 906-2494 long	24K - 40K Drills
906-2427 HD	5.12" / 130.04 mm	2.5"	906-2446 med / 906-2494 long	24K - 40K Drills
906-5026	6.12" / 157.48 mm	3.375"	906-5082 med / 906-5090 long	50K - 100K Drills
906-5027 HD	6.12" / 155.44 mm	3.375"		50K - 100K Drills
906-1827	TriHawk I Pullback Tool			5K - 12K Drills
906-2627	TriHawk I Pullback Tool			16K - 40K Drills

TriHawk I HD



TriHawk I with Pullback

Note: Please contact your local dealer about our rebuildable program that provides reduced operating costs.

## TRIHAWK® III

TriHawk III features superior abrasion resistance and massive, carbide-core cutting teeth designed to efficiently cut through soft to medium rock and cobble. Welded carbide grit is applied not only to the bit surface, but also into grooves that are cut into high-wear areas, keeping the bit surface smooth and resulting in less resistance when pushing to steer.



PART NUMBERS	CUT	SPLINE SIZE	REPLACEMENT TEETH	DRILL SIZE
906-1719	4.38" / 111.25 mm	2.125"	906-1713	16K - 20K Drills
906-2519	5.5" / 139.7 mm	2.5"	906-2516	24K - 40K Drills
906-5119	6.6" / 167.64 mm	3.375"	906-5116	50K - 100K Drills
906-1513	10.0" / 254 mm	4.5 F API IF	906-1512	150K - 300K Drills
906-1527	12.5" / 317.5 mm	6.625 F FH	906-1530	500K Drills +
906-1723	TriHawk III Pull Back		Use with	906-1719
906-2523	TriHawk III Pull Back		Use with	906-2519



## TRIHAWK IV

The TriHawk IV drill bit is designed for use in heavy, overburdened cobble or fractured rock. Our bit is machined from high-grade alloy steel and engineered to reduce machine vibration in tough drilling conditions. The TriHawk IV's numerous carbide chisels are positioned to help provide smooth, rotational drilling and fracture clearance space for the housing.



PART NUMBERS	CUT	SPLINE SIZE	DRILL SIZE
906-1730	4.38" / 111.25 mm	2.125"	16K - 20K Drills
906-2530	5.5" / 139.7 mm	2.5"	24K - 40K Drills
906-5130	6.6" / 167.64 mm	3.375"	50K - 100K Drills





SOIL CONDITION CHART KEY ● =Best ○ =Better ○ =Good

## TRIHAWK V

The innovative design of TriHawk V combines torque-edge steering with thrust-face steering to provide unbeatable performance in round rock cobble, flat river stone, and loose fill. TriHawk V's patented J-tapered torque edge feature converts rotational torque to direct steering thrust, which gives the operator exceptional control. The key to TriHawk V's outstanding productivity is the tapering of the leading edge toward the bit's trailing edge.



PART NUMBERS	CUT	SPLINE SIZE	DRILL SIZE
906-0708	3.5" / 88.9 mm	6 Hole VM - Bolt-on	5K - 12K Drills
906-0792	3.5" / 88.9 mm	5 Hole DW - Bolt-on	5K - 12K Drills
906-1771	3.88" / 98.55 mm	2.125"	16K - 20K Drills
906-2571	4.8" / 121.92 mm	2.5"	24K - 40K Drills
906-5171	7" / 177.8 mm	3.375"	50K - 100K Drills
906-1523	9" / 228.6 mm	4.5 F API IF	150K - 300K Drills
906-0825	TriHawk V Pullback		5K - 12K Drills
906-1825	TriHawk V Pullback		16K - 20K Drills
906-2625	TriHawk V Pullback		24K - 40K Drills



TriHawk V with Pullback

## TRIHAWK REAMER BIT



Intended to use for fast, easy, small-diameter installations. When you finish a bore with your TriHawk system, simply drive out the two roll pins holding the bit and install the reamer bit instead. This cast reamer is equipped with a pulling tab intended to be used in conjunction with a swivel and will cut a 5.25" hole.

PART NUMBERS	CUT	SPLINE SIZE	DRILL SIZE
906-1812	6" / 152.4 mm	2.125"	16K - 20K Drills
906-2712	6" / 152.4 mm	2.5"	24K - 40K Drills



## TRIHAWK® DIRT BIT ADAPTERS

PART NUMBERS	HOUSING DIAMETER	SPLINE SIZE	BOLT PATTERN	NOZZLES
906-1796	3" TriHawk HD	2.125"	5 Hole DW / 12 mm	2
906-2697	3.5" TriHawk HD	2.5"	6 Hole DW / 16 mm	2
906-2698	3.5" TriHawk HD	2.5"	6 Hole DW / 20 mm	2
906-5296	4.25" TriHawk HD	3.375"	6 Hole DW / 20 mm	2
906-1665	3" TriHawk HD	2.125"	6 Hole VM (1/2" Bolt)	2
906-2465	3.5" TriHawk HD	2.5"	6 Hole VM (1/2" Bolt)	2
906-5165	4.25" TriHawk HD	3.375"	6 Hole VM (5/8" Bolt)	2
906-5166	4.25" TriHawk HD	3.375"	6 Hole VM (3/4" Bolt)	2



Vermeer® Compatible

## TRIHAWK PULLERS

PART NUMBERS	DESCRIPTION	SPLINE SIZE	DRILL SIZE
906-1593	TriHawk HSG Pull Tab	2.125" F	10K - 20K Drills
906-2493	TriHawk HSG Pull Tab	2.5" F	24K - 40K Drills







# DITCH WITCH® ROCKMASTER®

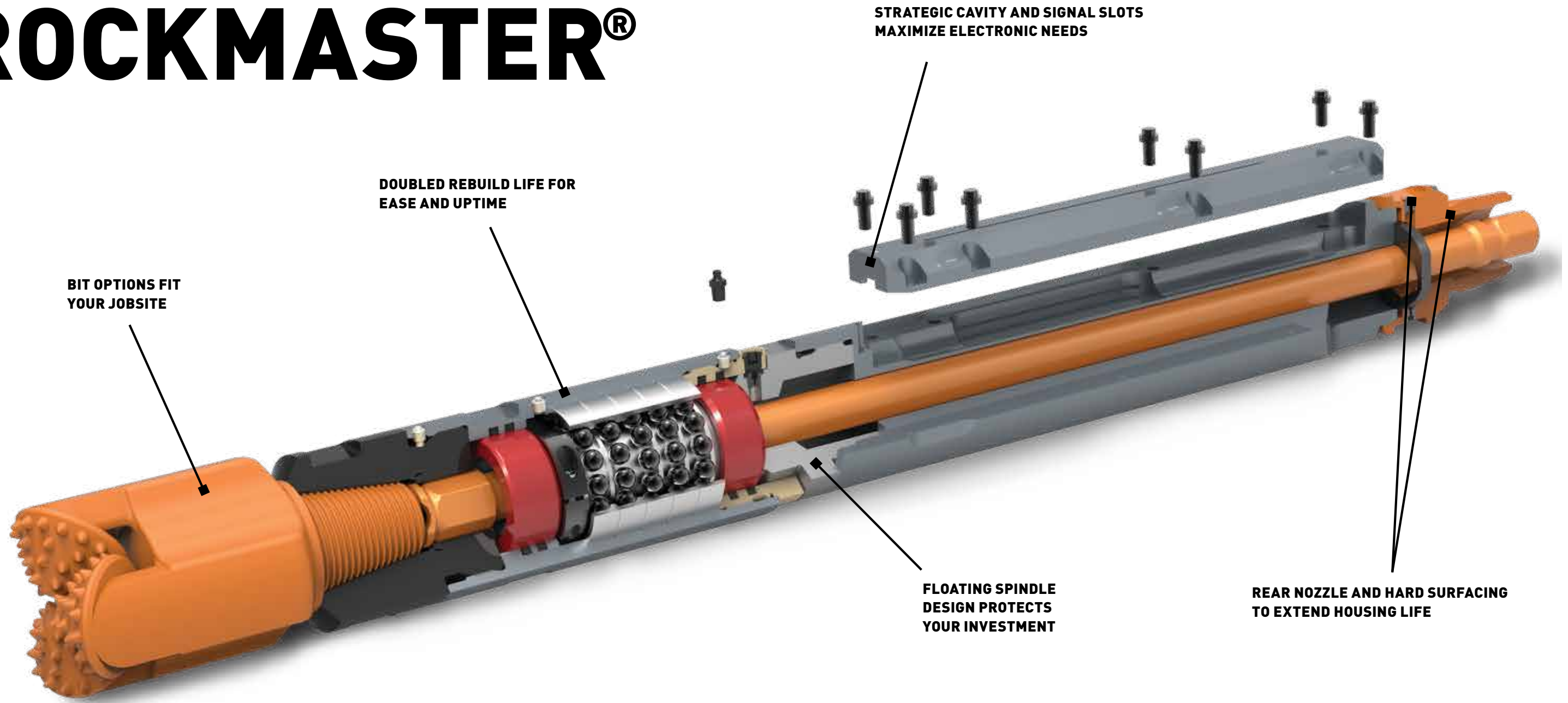

BIT OPTIONS FIT  
YOUR JOBSITE

DOUBLED REBUILD LIFE FOR  
EASE AND UPTIME

STRATEGIC CAVITY AND SIGNAL SLOTS  
MAXIMIZE ELECTRONIC NEEDS

FLOATING SPINDLE  
DESIGN PROTECTS  
YOUR INVESTMENT

REAR NOZZLE AND HARD SURFACING  
TO EXTEND HOUSING LIFE



# CRUSH THROUGH ROCK. CRUSH THROUGH THE COMPETITION.



## ROCKMASTER® AT HOUSINGS

RockMaster All Terrain housings are the only housings designed and manufactured to provide superior performance with the All Terrain technology, which allows you to steer while drilling and are designed with a 2° offset for responsive steering.

PART NUMBERS	STYLE	DESCRIPTION	ELECTRONICS	MODEL(S)	BOLTS FOR LID
401-159	3.75" RockMaster 2°	2.77 DS / AT30 / 2.88 API R	88 Series	AT2720 / AT30	107-433 6x
401-329	3.75" RockMaster 2°	2.77 DS / AT30 / 2.88 API R	15T / 17T	AT2720 / AT30	106-891 6x
400-3162*	4.5" RockMaster 2°	2.77 DS / AT30 / 2.88 API R	15T / 17T	AT2720 / AT30	106-891 8x
400-3163*	4.5" SwitchBack™ 2°	2.77 DS / AT30 / 2.88 API R	15T / 17T	AT2720 / AT30	106-891 8x
350-1254	4.75" RockMaster 2°	2.77 DS / AT30 / 2.88 API R	15T / 17T	AT2720 / AT30	106-891 8x
400-2460*	4.75" RockMaster 2°	2.95 DS / AT40 / 2.88 API R	15T / 17T / 19T	AT40	106-891 8x
400-2630*	4.75" RockMaster 2.5°	2.95 DS / AT40 / 3.5 API R F	15T / 17T / 19T	AT40	106-891 8x
400-919*	5" RockMaster 1.5°	3.25 SS / AT4020 / 3.5 API R	15T / 17T	AT4020 / AT60	106-891 8x
400-1467*	5" RockMaster 2°	3.25 SS / AT4020 / 3.5 API R	15T / 17T	AT4020 / AT60	106-891 8x
400-1488*	5" RockMaster 2°	3.44 SS / AT100 / 3.5 API R	15T / 17T	AT100	106-891 8x

\* Air Capable  
Note: DCI® isolation kit is 908-4306.

## AT30 SWITCHBACK ACCESSORIES

PART NUMBERS	DESCRIPTION
400-3094	SwitchBack Adapter [2-7/8" API-Reg]
400-3100	10K SwitchBack Swivel Assembly

Engineered to deliver the most impact in the toughest conditions, the RockMaster AT Housings are your go-to components for jobsite challenges. The RockMaster AT housings feature a more robust bearing design, a higher-strength door, easy serviceability and high flow capacity. And as with all Ditch Witch® equipment, they're manufactured with the quality you expect, so you take on any job with confidence. And a whole lot of power.

# ROCKING THE INDUSTRY SINCE 1996.

<b>1996</b>	<b>2000</b>	<b>2017</b>	<b>2019</b>
Revolutionized HDD rock drilling with RockMaster® technology.	The revolution continues with All Terrain technology.	The future is now with new 12-point Patented Hex Design.	The SwitchBack® System changes the way you drill.



The International Association of Drilling Contractors (IADC) developed a system to describe any tricone bit through a simple 4-digit number. This streamlines the process of ordering a new tricone bit for drillers everywhere. By coming up with a simple 4-digit code to describe and categorize any tri-cone bit they eliminated any confusion that can arise when ordering. This classification system dedicates the first 3 digits to the design and function of the tricone, with the final digit being an alphabetical code for any additional features of the bit.

## IADC NUMBER DESIGNATION SYSTEM

First Number Type of Bit	Second Number Formation Hardness	Third Number Bit Features
1-Steel Tooth, Soft Formation	1-Soft Formation	1-Standard Open Bearing
2-Steel Tooth, Medium Formation	1-Soft Formation	2-Standard Open Bearing/Air Cooled
3-Steel Tooth, Hard Formation	2-Medium-Soft Formation	3-Standard Open Bearing/Gage Protected
4-Tungsten Carbide Insert Bits	2-Medium-Soft Formation	4-Sealed Roller Bearing
5-Tungsten Carbide Insert Bits, Soft Formation	3-Medium-Hard Formation	5-Sealed Roller Bearing/Gage Protected
6-Tungsten Carbide Insert Bits, Medium-Soft Formation	3-Medium-Hard Formation	6-Sealed Journal Bearing
6-Tungsten Carbide Insert Bits, Hard Formation	4-Hard Formation	7-Sealed Journal Bearing/Gage Protected
7-Tungsten Carbide Insert Bits, Medium-Hard Formation	4-Hard Formation	7-Sealed Journal Bearing/Gage Protected

For Example: A Roller Cone Bit with a 517 IADC code means the bit has Tungsten Carbide Inserts Designed for Soft Formations, and has a Sealed Journal Bearing and Gage Protection.



## ROCKMASTER® BIT

The RockMaster bit is engineered with patented Edgeguard™ shirt tail protection, premium bearing technology utilizing high-performance components to extend bit life in hard rock conditions with an HDD application. Designed for Ditch Witch All Terrain drills.

PART NUMBERS	CUT	THREAD	DESCRIPTION
400-2317	5.5" / 139.7 mm	2.88 API R	TCI Open Bearing IADC:533
400-2319	5.5" / 139.7 mm	2.88 API R	TCI Sealed Bearing IADC:517
400-2517	5.5" / 139.7 mm	2.88 API R	TCI Sealed Bearing IADC:637
400-2320	6.5" / 165.1 mm	3.5 API R	TCI Sealed Bearing IADC:537
400-2516	6.5" / 165.1 mm	3.5 API R	TCI Sealed Bearing IADC:637
400-2420	4.75" / 120.65 mm	2.88 API R	TCI Sealed Bearing IADC:517
400-2421	4.75" / 120.65 mm	2.88 API R	TCI Open Bearing IADC:533

COBBLE ROCK	SOFT ROCK	MEDIUM ROCK	HARD ROCK
○	◐	●	◐
○	◐	●	◐
○	○	◐	●
○	◐	●	◐
○	○	◐	●
○	◐	●	◐
○	◐	●	◐





# DITCH WITCH® TRI-CONE BIT

Made with high-performance components and tungsten carbide, or steel tooth design options. The Tri-Cone Bit is perfect for variable ground conditions.

COBBLE ROCK	SOFT ROCK	MEDIUM ROCK	HARD ROCK
○	●	○	●
○	●	○	●
○	●	○	●
○	●	○	●

## OPEN BEARING

PART NUMBERS	CUT	THREAD	DESCRIPTION
400-2314	4.75" / 120.65 mm	2.88 API R	TCI IADC:612
400-2520	5.5" / 139.7 mm	2.88 API R	MT IADC:211
400-2521	6.5" / 165.1 mm	3.5 API R	MT IADC:211
400-2316	5.625" / 142.87 mm	3.5 API R	TCI IADC:612
400-2315	5.625" / 142.87 mm	3.5 API R	MT IADC:211

COBBLE ROCK	SOFT ROCK	MEDIUM ROCK	HARD ROCK
○	○	○	●
○	○	○	●
○	○	○	●
○	○	○	●
○	○	○	●
○	○	○	●
○	○	○	●
○	○	○	●

## SEALED BEARING

PART NUMBERS	CUT	THREAD	DESCRIPTION
401-345	5.5" / 139.7 mm	2.88 API R	TCI HDX40 IADC:627
401-349	5.5" / 139.7 mm	2.88 API R	TCI HDS2 IADC:517
401-361	6.5" / 165.1 mm	3.5 API R	TCI HDS3 IADC:537
401-346	6.5" / 165.1 mm	3.5 API R	TCI HDX30 IADC:547
400-1812	6.5" / 165.1 mm	3.5 API R	TCI XR50 IADC:627
400-2740	5.5" / 139.7 mm	2.88 API R	TCI IADC:727
400-2741	6.5" / 165.1 mm	3.5 API R	TCI IADC:727
400-2318	6.5" / 165.1 mm	3.5 API R	TCI IADC:537

Note: MT = Mill Tooth and TCI = Tungsten Carbide Inserts  
 Note: Refer to IADC code on page 60.



SOFT SOIL	HARD SOIL	COBBLE ROCK	SOFT ROCK
○	○	○	●

# PIRANHA BIT

PART NUMBERS	CUT	THREAD	INSERT BIT	QUANTITY
400-2972	5.5 / 139.7 mm	2.88 API-REG	135-1630	4
400-2973	6.5 / 165.1 mm	3.5 API-REG	135-1630	6

# NOZZLES

## ROCKMASTER® AND TRI-CONE BIT NOZZLES

PART NUMBERS	DESCRIPTION	ORIFICE SIZE	RETENTION TYPE	COMPATIBLE BITS
159-1016	Jet Nozzle	.125"	Snap Ring	400-2319, 400-2517, 400-2420
159-1017	Jet Nozzle	.25"	Snap Ring	400-2319, 400-2517, 400-2420
159-1018	Jet Nozzle	.375"	Snap Ring	400-2319, 400-2517, 400-2420
159-1019	Jet Nozzle	.125"	Nail	400-2421, 400-2316
159-1020	Jet Nozzle	.25"	Nail	400-2421, 400-2316
159-1021	Jet Nozzle	.375"	Nail	400-2421, 400-2316
159-1022	Jet Nozzle	.375"	Snap Ring	400-2320, 400-2516, 400-2318
159-1023	Jet Nozzle	.5"	Snap Ring	400-2320, 400-2516, 400-2318
159-1024	Jet Nozzle	.62"	Snap Ring	400-2320, 400-2516, 400-2318
159-1029	Jet Nozzle	.125"	Snap Ring	400-2740
159-1030	Jet Nozzle	.25"	Snap Ring	400-2740
159-1031	Jet Nozzle	.375"	Snap Ring	400-2740
159-1032	Jet Nozzle	.25"	Snap Ring	400-2741
159-1033	Jet Nozzle	.375"	Snap Ring	400-2741
159-1034	Jet Nozzle	.562"	Snap Ring	400-2741

Note: Sold in quantities of three.







# THE TOUGHEST TOOLS FOR THE TOUGHEST TERRAIN.



Kits Include: RockMaster® Housing, All Terrain Air Hammer, 6.5" convex bit, fluid/air adapter kit, wrench jaws and pins.

## ALL TERRAIN AIR HAMMER

PART NUMBERS	STYLE	DESCRIPTION	ELECTRONICS	MODEL(S)
190-1692	6" Air Hammer Kit	AT4020 / 3.5" API R	15T / 17T	AT4020
190-1932	6" Air Hammer Kit	AT60 / 3.5" API R	15T / 17T	AT60
190-1701	6" Air Hammer Kit	AT100 / 3.5" API R	15T / 17T	AT100 with 120 gpm
190-1969	6" Air Hammer Kit	AT100 / 3.5" API R	15T / 17T	AT100 with 200 gpm

\*Contact your dealer for more information.

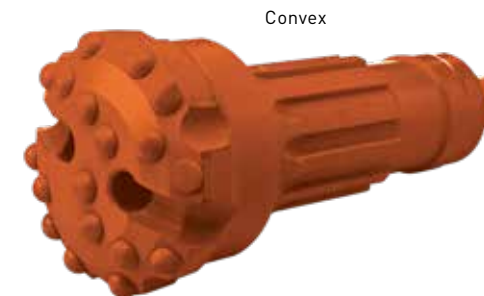

Convex



Concave

## AIR HAMMER BITS

PART NUMBERS	STYLE	DESCRIPTION	JAW PART NUMBER
400-1451	Concave / Spherical Inserts	6.5"	400-1486
400-1452	Convex / Spherical Inserts*	6.5"	400-1477
400-1454	Convex / Semi-Ballistic Inserts	6.5"	400-1487
400-1455	Convex / Ballistic Inserts	6.5"	400-1487

\*Comes standard in all AT air hammer kits.

Advanced technology enables the All Terrain Air Hammer to continuously drill as it is being steered, an exclusive All Terrain drill feature that results in superior productivity; no loss of productivity while steering.

Your All Terrain Air Hammer works like nothing else. It's designed to penetrate the hardest rock where rotary bits lose effectiveness. To ensure superior performance, trust genuine Ditch Witch® Air Hammer housings—the only parts designed, manufactured and tested by the creators of All Terrain technology.



# UNRIVALED VERSATILITY. UNIVERSAL PRODUCTIVITY.



## UNIVERSAL HD HOUSINGS

Universal HD housings are designed for maximum flow rate to be used with mud motor, air hammers and threaded bit applications. These are wireline capable and can accept 15" through 19" beacons.

PART NUMBERS	DIAMETER	FRONT THREADS	REAR THREADS	MODEL(S)
908-1690	3.25"	2.38 API R F	2.38 API R F	JT20 / JT2020 / D16x20 / D18x20 / D20X22 / D24X26 / D24X33
908-4290	3.75"	2.38 API R F	2.38 API R F	JT25 / JT3020 / JT30 / AT30 / D24X40 / D33X44 / D36X50
908-4390	4.25"	2.88 API R F	2.88 API R F	JT40 / JT60 / DD110
908-5290	4.75"	3.5 API I F F	3.5 API I F F	JT7020 / JT8020 / JT100 / AT40 / AT60 / AT100 / D50X100 / D55X100 / D60X90 / D75X100 / D80X10 / D100X120 / DD110
400-1426*	4.75"	3.5 API I F	3.5 API I F	JT7020 / JT8020 / JT100 / AT40 / AT60 / AT100 / D50X100 / D55X100 / D60X90 / D75X100 / D80X10 / D100X120 / DD110
400-1000**	4.75"	3.5 API I F	3.5 API I F	JT7020 / JT8020 / JT100 / AT40 / AT60 / AT100 / D50X100 / D55X100 / D60X90 / D75X100 / D80X10 / D100X120 / DD110
908-6190	6.5"	4.5 API I F M	4.5 API I F F	150K - 330K
908-8090	8"	6.625 API F H M	6.625 API F H F	400K - 1000K

\* BHL Electronics Only.

\*\* Not wireline compatible.

Note: These housings will accommodate Subsite® Electronics and DCI® Electronics, including the 19" sonde.

The Ditch Witch® Universal Housings deliver unbeatable flexibility, allowing you to do more using the same housing for a variety of tasks. Run threaded options such as mud motors, air hammers and threaded bits, all with the same component. Universal Housings are wireline capable and accept 15" through 19" beacons, so you tackle more jobs, increasing your productivity and your ROI.





# UNIVERSAL HD HOUSING ADAPTERS

PART NUMBERS	FRONT THREADS	SPLINE SIZE	BOLT SIZE	HOUSING	ADAPTER
906-1810	2.38 API M	2.125"		908-1690	Universal to TriHawk®
906-2585	2.38 API R M	2.5"		908-4290 / 908-1690	Universal to TriHawk
906-2478	2.88 API R M	2.5"		908-4290 / 908-1690	Universal to TriHawk
906-5310	3.5 API IF M	3.375"		908-5290	Universal to TriHawk
906-1720	2.38 API R M		12 mm	908-1690	Bit adapter
906-2637	2.38 API R M		16 mm	908-1690	Bit adapter
906-2636	2.38 API R M		20 mm	908-4290	Bit adapter
906-5312	2.88 API R M		20 mm	908-4390	Bit adapter
906-5298	3.5 API IF M		20 mm	908-5290	Bit adapter

# UNIVERSAL HD HOUSING ACCESSORIES

DIAMETER	HOUSING	LID	LID PIN	COIL PIN	LID BOLT
3.25	908-1690	908-4283	906-2652	906-2405	906-2633
3.75	908-4290	908-4283	906-2652	906-2405	906-2633
4.25	908-4390	908-4283	906-2652	906-2405	906-2633
4.75	908-5290	908-4283	906-2652	908-0019	906-2633
6.5	908-6190	908-4283	906-2652	906-2409	906-2633
8	908-8090	908-4283	906-2652	906-2409	906-2633



Choosing the ideal bit for a particular type of soil can be challenging. This chart offers guidelines to help, but for specific recommendations for your area, ask your Ditch Witch® dealer.

## SOIL CONDITION CHART

Key ●=Best ◐=Better ○=Good

	Sandy Soil	Soft Soil	Medium Soil	Hard Soil	Cobble Rock	Soft Rock	Medium Rock	Hard Rock
Durabit	◐	◐	●	◐				
Steep Taper Bit		◐	●					
Steep Taper Tuff Bit			◐	●	●	○		
Omni Bit	●	●	●	●	○	○		
Tornado Bit	◐	◐	●	◐	○	○		
Tuff Bit	◐	●	●	●	◐	○		
Shot Gun Bit		●	●	●	◐			
Rhino Rock Bit		◐	●		○	●		
TriHawk® I		○	◐	●	◐	●		
TriHawk III		○	○	◐	◐	●		
TriHawk IV				○	●	◐		
TriHawk V				○	●			
TriHawk Reamer Bit	●	●	●	◐	○			
Piranha Bit		○		◐	◐	●		

## SOIL TYPE DESCRIPTION CHART

Sandy Soil	Sugar sand, blow sand or other solids where sand is the predominant component
Soft Soil	Sandy loam
Medium Soil	Loams, loamy clays
Hard Soil	Packed clays, gumbo, all compacted soils
Cobble Rock	Chunk rock, glacier till, cobble, gravel, flat river stone
Soft Rock	Sandstone, shale, coral, caliche, chalk
Medium Rock	Limestone, caliche, sandstone, shale
Hard Rock	Granite, schist, marble, hard limestone

This chart is meant as a guideline only. See your local Ditch Witch dealer for recommendations in your area.





**BUILT  
BETTER  
TO LAST  
LONGER.**

Featuring a heavy-duty design, Ditch Witch® backreamers are ruggedly built to last longer. They're also the most versatile, designed to tackle the cutting and expanding requirements of extreme soil conditions like rock, chunk rock and cobble, and also effectively manage the spoils of long bores. If you demand superior performance, look for backreamers designed, manufactured and extensively tested by the same experts who built the drills that drive them. Demand Ditch Witch HDD Tooling.

Choosing the ideal backreamer for a particular type of soil can be challenging. This chart offers guidelines to help, but for specific recommendations for your area, ask your Ditch Witch® dealer.

**SOIL CONDITION CHART**

Key ● =Best ◐ =Better ○ =Good

	Sandy Soil	Soft Soil	Medium Soil	Hard Soil	Cobble Rock	Soft Rock	Medium Rock	Hard Rock
Compact Fluted HD	○	○	●	◐		○		
Kodiak™ HD			○	◐	●	◐		
Beavertail HD	◐	●	●	●				
Warthog™ HD		○	◐	●		○		
RockMaster®					○	●		●
Sandhog HD	●	◐	○					
Rock Monster™ HD						●	●	◐
Swab				●	◐			
EZ			◐	●	○			

This chart is meant as a guideline only. See your local Ditch Witch dealer for recommendations in your area.

**SOIL TYPE DESCRIPTION CHART**

<b>Sandy Soil</b>	Sugar sand, blow sand, or other solids where sand is the predominant component
<b>Soft Soil</b>	Sandy loam
<b>Medium Soil</b>	Loams, loamy clays
<b>Hard Soil</b>	Packed clays, gumbo, all compacted soils
<b>Cobble Rock</b>	Chunk rock, glacier till, cobble, gravel
<b>Soft Rock</b>	Sandstone, shale, coral, caliche, chaulk
<b>Medium Rock</b>	Limestone, caliche, sandstone, shale
<b>Hard Rock</b>	Granite, schist, marble, hard limestone

**FLANGED SWIVEL / STATIC PLATE**

PART NUMBERS	DESCRIPTION
190-2359	12K Swivel Kit (12K Clevis)
190-2360	12K Swivel Kit (12K Tab)
190-2361	20K Swivel Kit (20K Clevis)
190-2362	20K Swivel Kit (20K Tab)
190-2363	30K Swivel Kit (30K Clevis)
190-2364	30K Swivel Kit (30K Tab)
190-2365	40K/60K Swivel Kit (40K Clevis)
190-2366	40K/60K Swivel Kit (40K Tab)
190-2367	100K Swivel Kit (100K Clevis)
190-2368	100K Swivel Kit (100K Tab)
190-2613	12K Static Kit (12K Tab)
400-2368	12K Static Kit (20K Tab)
190-2614	20K Static Kit (20K Tab)
190-2615	30K Static Kit (30K Tab)
190-2616	40K/60K Static Kit (40K Tab)
190-2617	100K Static Kit (100K Tab)

Utilizing high-performance components to extend life and featuring a new clevis design, our flange swivel options eliminate the need for multiple connections between the reamer and product. They also position the product closer to the reamer, reducing the possibility of binding.



190-2615

Note: Flanged swivel options for Compact Fluted HD and Kodiak backreamers.





SOIL CONDITION CHART KEY ●=Best ○=Better ○=Good

# COMPACT FLUTED HD BACKREAMERS

All of our Compact Fluted HD Backreamers are built with integrated swivel options that position the product closer to the reamer, which reduces the possibility of binding. Fluid distribution is enhanced with a replaceable hardened steel nozzle for flow flexibility allowing cuttings and fluid to flow behind the reamer over the product. The improved casting design and tapered base provide smooth pushback capability. As with all our tooling products, these backreamers feature heavy-duty components for extended life.

SOFT SOIL ○ SANDY SOIL ○ MEDIUM SOIL ● HARD SOIL ○ SOFT ROCK ○

PART NUMBERS	CUT	SHAFT	DESCRIPTION	NPT/ORIFICE/NOZZLE QTY.	MODEL(S)
400-2652	4.5" / 114.3 mm	2.0"	1.10-5 F / 12K FLG	1/4" / .188 - 4	5K
400-2543	4.5" / 114.3 mm	2.75"	2.0 API-IF F / 12K FLG	1/4" / .188 - 4	9K - 20K
400-2544	6.5" / 165.1 mm	2.75"	2.0 API-IF F / 12K FLG	1/4" / .188 - 9	9K - 20K
400-2545	8" / 203.2 mm	2.75"	2.0 API-IF F / 20K FLG	1/4" / .188 - 12	9K - 20K
400-2546	10" / 254 mm	2.75"	2.0 API-IF F / 20K FLG	1/4" / .188 - 12	9K - 20K
400-2547	12" / 304.8 mm	2.75"	2.0 API-IF F / 20K FLG	1/4" / .188 - 15	9K - 20K
400-2683	6.5" / 165.1 mm	3.25"	2.38 API R F / 20K FLG	1/4" / .188 - 6	16K - 36K
400-2396	8" / 203.2 mm	3.25"	2.38 API R F / 20K FLG	1/4" / .188 - 12	16K - 36K
400-2397	10" / 254 mm	3.25"	2.38 API R F / 20K FLG	1/4" / .188 - 12	16K - 36K
400-2398	12" / 304.8 mm	3.25"	2.38 API R F / 30K FLG	1/4" / .188 - 15	16K - 36K
400-2399	14" / 355.6 mm	3.25"	2.38 API R F / 30K FLG	1/4" / .188 - 18	16K - 36K
400-2400	16" / 406.4 mm	3.25"	2.38 API R F / 30K FLG	1/4" / .188 - 18	16K - 36K
400-2401	18" / 457.2 mm	3.25"	2.38 API R F / 30K FLG	1/4" / .188 - 18	16K - 36K
400-2485	8" / 203.2 mm	4.25"	2.88 API R F / 20K FLG	1/4" / .188 - 12	40K - 60K
400-2486	10" / 254 mm	4.25"	2.88 API R F / 20K FLG	1/4" / .188 - 12	40K - 60K
400-2487	12" / 304.8 mm	4.25"	2.88 API R F / 30K FLG	1/4" / .188 - 15	40K - 60K
400-2488	14" / 355.6 mm	4.25"	2.88 API R F / 40K FLG	1/4" / .188 - 18	40K - 60K
400-2489	16" / 406.4 mm	4.25"	2.88 API R F / 40K FLG	1/4" / .188 - 18	40K - 60K
400-2490	18" / 457.2 mm	4.25"	2.88 API R F / 40K FLG	1/4" / .188 - 18	40K - 60K
400-2491	12" / 304.8 mm	4.75"	3.5 API-IF F / 30K FLG	1/4" / .188 - 15	70K - 100K
400-2492	14" / 355.6 mm	4.75"	3.5 API-IF F / 100K FLG	1/4" / .188 - 19	70K - 100K
400-2493	16" / 406.4 mm	4.75"	3.5 API-IF F / 100K FLG	1/4" / .188 - 19	70K - 100K
400-2494	18" / 457.2 mm	4.75"	3.5 API-IF F / 100K FLG	1/4" / .188 - 19	70K - 100K
400-2495	20" / 508 mm	4.75"	3.5 API-IF F / 100K FLG	1/4" / .188 - 22	70K - 100K
400-2496	22" / 558.8 mm	4.75"	3.5 API-IF F / 100K FLG	1/4" / .188 - 22	70K - 100K
400-2497	24" / 609.6 mm	4.75"	3.5 API-IF F / 100K FLG	1/4" / .188 - 25	70K - 100K
400-2498	26" / 660.4 mm	4.75"	3.5 API-IF F / 100K FLG	1/4" / .188 - 18	70K - 100K

Find your flanged swivel and static plate options on page 63.

Note: Swivel and static plate sold separately.



# KODIAK™ HD

MEDIUM SOIL ○ HARD SOIL ● COBBLE ROCK ● SOFT ROCK ○



Its name says it all. The Kodiak is the ultimate backreamer for challenging conditions. Designed for extreme soils like rock, chunk rock and cobble, its spiraling flutes allow for cuttings and fluid to flow behind the reamer over the product. It also features an improved plate design and tapered tail end to better accommodate pushing back. The Kodiak is a great reamer for compacting and pushing chunk and cobble rock away from the bore path to make easier install of product.

PART NUMBERS	CUT	SHAFT	DESCRIPTION	NPT/ORIFICE/NOZZLE QTY.	MODEL(S)
400-2599	8" / 203.2 mm	2.75"	2.0 API IF F / 12K FLG	1/4" / .250 - 12	9K - 20K
400-2600	10" / 254 mm	2.75"	2.0 API IF F / 20K FLG	1/4" / .250 - 15	9K - 20K
400-2601	12" / 304.8 mm	2.75"	2.0 API IF F / 20K FLG	1/4" / .250 - 18	9K - 20K
400-2357	8" / 203.2 mm	3.25"	2.38 API R F / 12K Flange	1/4" / .188 - 12	16K - 36K
400-2358	10" / 254 mm	3.25"	2.38 API R F / 20K Flange	1/4" / .188 - 15	16K - 36K
400-2359	12" / 304.8 mm	3.25"	2.38 API R F / 20K Flange	1/4" / .188 - 18	16K - 36K
400-2360	14" / 355.6 mm	3.25"	2.38 API R F / 30K Flange	1/4" / .188 - 21	16K - 36K
400-2361	16" / 406.4 mm	3.25"	2.38 API R F / 30K Flange	1/4" / .188 - 24	16K - 36K
400-2362	18" / 457.2 mm	3.25"	2.38 API R F / 30K Flange	1/4" / .188 - 27	16K - 36K
400-2500	10" / 254 mm	4.25"	2.88 API R F / 30K Flange	1/4" / .188 - 9	40K - 60K
400-2501	12" / 304.8 mm	4.25"	2.88 API R F / 30K Flange	1/4" / .188 - 15	40K - 60K
400-2502	14" / 355.6 mm	4.25"	2.88 API R F / 40K Flange	1/4" / .188 - 19	40K - 60K
400-2503	16" / 406.4 mm	4.25"	2.88 API R F / 40K Flange	1/4" / .188 - 22	40K - 60K
400-2504	18" / 457.2 mm	4.25"	2.88 API R F / 40K Flange	1/4" / .188 - 25	40K - 60K
400-2505	20" / 508 mm	4.25"	2.88 API R F / 40K Flange	1/4" / .188 - 22	40K - 60K
400-2506	24" / 609.6 mm	4.25"	2.88 API R F / 40K Flange	1/4" / .188 - 25	40K - 60K
400-2507	28" / 711.2 mm	4.25"	2.88 API R F / 40K Flange	1/4" / .188 - 28	40K - 60K
400-2588	12" / 304.8 mm	4.75"	3.5 API IF F / 30K Flange	1/4" / .250 - 12	70K - 100K
400-2589	14" / 355.6 mm	4.75"	3.5 API IF F / 40K Flange	1/4" / .250 - 16	70K - 100K
400-2590	16" / 406.4 mm	4.75"	3.5 API IF F / 100K Flange	1/4" / .250 - 19	70K - 100K
400-2591	18" / 457.2 mm	4.75"	3.5 API IF F / 100K Flange	1/4" / .250 - 22	70K - 100K
400-2592	20" / 508 mm	4.75"	3.5 API IF F / 100K Flange	1/4" / .250 - 22	70K - 100K
400-2593	24" / 609.6 mm	4.75"	3.5 API IF F / 100K Flange	1/4" / .250 - 22	70K - 100K
400-2594	28" / 711.2 mm	4.75"	3.5 API IF F / 100K Flange	1/4" / .250 - 25	70K - 100K
400-2595	30" / 762 mm	4.75"	3.5 API IF F / 100K Flange	1/4" / .250 - 28	70K - 100K
400-2596	34" / 863.6 mm	4.75"	3.5 API IF F / 100K Flange	1/4" / .250 - 31	70K - 100K
400-2597	36" / 914.4 mm	4.75"	3.5 API IF F / 100K Flange	1/4" / .250 - 31	70K - 100K

Find your flanged swivel and static plate options on page 63.

Note: Swivel and static options sold separately.





# BEAVERTAIL HD BACKREAMER

With its low-weight design and low-resistance profile, the Beavertail allows for more efficient fluid-mixing capabilities downhole, requiring less horsepower for rotation. It features a replaceable, hardened-steel Allen-head nozzle for flow flexibility and consistent carbide Shark® teeth for improved life.



PART NUMBERS	CUT	SHAFT	DESCRIPTION	NPT/ORIFICE/NOZZLE QTY.	MODEL(S)
400-1439*	4.5" / 114.3 mm	2.0"	1.10-5 F / 12K TAB	7/16" / .188	5K
400-2602	6" / 152.4 mm	2.75"	2.0 API IF F / 20K TAB	1/4" / .188 - 13	9K - 20K
400-2603	8" / 203.2 mm	2.75"	2.0 API IF F / 20K TAB	1/4" / .188 - 13	9K - 20K
400-2604	10" / 254 mm	2.75"	2.0 API IF F / 20K TAB	1/4" / .188 - 13	9K - 20K
400-2605	12" / 304.8 mm	2.75"	2.0 API IF F / 20K TAB	1/4" / .188 - 13	9K - 20K
400-2606	14" / 355.6 mm	2.75"	2.0 API IF F / 20K TAB	1/4" / .188 - 13	9K - 20K
400-2607	16" / 406.4 mm	2.75"	2.0 API IF F / 20K TAB	1/4" / .188 - 13	9K - 20K
400-2608	18" / 457.2 mm	2.75"	2.0 API IF F / 20K TAB	1/4" / .188 - 13	9K - 20K
400-2609	20" / 508 mm	2.75"	2.0 API IF F / 20K TAB	1/4" / .188 - 13	9K - 20K
400-2974	6" / 152.4 mm	2.75"	2.38 API R F / 20K TAB	1/4" / .188 - 13	16K - 36K
400-2381	8" / 203.2 mm	3.25"	2.38 API R F / 2.38 API R F	1/4" / .188 - 13	16K - 36K
400-2382	10" / 254 mm	3.25"	2.38 API R F / 2.38 API R F	1/4" / .188 - 13	16K - 36K
400-2383	12" / 304.8 mm	3.25"	2.38 API R F / 2.38 API R F	1/4" / .188 - 13	16K - 36K
400-2384	14" / 355.6 mm	3.25"	2.38 API R F / 2.38 API R F	1/4" / .188 - 13	16K - 36K
400-2385	16" / 406.4 mm	3.25"	2.38 API R F / 2.38 API R F	1/4" / .188 - 13	16K - 36K
400-2386	18" / 457.2 mm	3.25"	2.38 API R F / 2.38 API R F	1/4" / .188 - 13	16K - 36K
400-2387	20" / 508 mm	3.25"	2.38 API R F / 2.38 API R F	1/4" / .188 - 13	16K - 36K
400-2388	24" / 609.6 mm	3.25"	2.38 API R F / 2.38 API R F	1/4" / .188 - 13	16K - 36K

\*Nozzles included. See page 81 for optional replacements.

Note: Threaded connection options on page 77 and 79.

# BEAVERTAIL HD BACKREAMER

○ SANDY SOIL
● SOFT SOIL
● MEDIUM SOIL
● HARD SOIL

PART NUMBERS	CUT	SHAFT	DESCRIPTION	NPT/ORIFICE/NOZZLE QTY.	MODEL(S)
400-2508	8" / 203.2 mm	4.25"	2.88 API R F / 2.88 API R F	3/8" / .250 - 13	40K - 60K
400-2509	10" / 254 mm	4.25"	2.88 API R F / 2.88 API R F	3/8" / .250 - 13	40K - 60K
400-2510	12" / 304.8 mm	4.25"	2.88 API R F / 2.88 API R F	3/8" / .250 - 13	40K - 60K
400-2511	14" / 355.6 mm	4.25"	2.88 API R F / 2.88 API R F	3/8" / .250 - 13	40K - 60K
400-2512	16" / 406.4 mm	4.25"	2.88 API R F / 2.88 API R F	3/8" / .250 - 13	40K - 60K
400-2513	18" / 457.2 mm	4.25"	2.88 API R F / 2.88 API R F	3/8" / .250 - 13	40K - 60K
400-2514	20" / 508 mm	4.25"	2.88 API R F / 2.88 API R F	3/8" / .250 - 13	40K - 60K
400-2515	24" / 609.6 mm	4.25"	2.88 API R F / 2.88 API R F	3/8" / .250 - 13	40K - 60K
400-2524	12" / 304.8 mm	4.75"	3.5 API IF F / 3.5 API IF F	3/8" / .250 - 13	60K - 100K
400-2525	14" / 355.6 mm	4.75"	3.5 API IF F / 3.5 API IF F	3/8" / .250 - 13	60K - 100K
400-2526	16" / 406.4 mm	4.75"	3.5 API IF F / 3.5 API IF F	3/8" / .250 - 13	60K - 100K
400-2527	18" / 457.2 mm	4.75"	3.5 API IF F / 3.5 API IF F	3/8" / .250 - 13	60K - 100K
400-2528	20" / 508 mm	4.75"	3.5 API IF F / 3.5 API IF F	3/8" / .250 - 13	60K - 100K
400-2529	24" / 609.6 mm	4.75"	3.5 API IF F / 3.5 API IF F	3/8" / .250 - 13	60K - 100K
400-2530	28" / 711.2 mm	4.75"	3.5 API IF F / 3.5 API IF F	3/8" / .250 - 13	60K - 100K
400-2531	30" / 762 mm	4.75"	3.5 API IF F / 3.5 API IF F	3/8" / .250 - 13	60K - 100K
400-2532	34" / 863.6 mm	4.75"	3.5 API IF F / 3.5 API IF F	3/8" / .250 - 13	60K - 100K
400-2533	36" / 914.4 mm	4.75"	3.5 API IF F / 3.5 API IF F	3/8" / .250 - 13	60K - 100K
400-2534	38" / 965.2 mm	4.75"	3.5 API IF F / 3.5 API IF F	3/8" / .250 - 13	60K - 100K
400-2535	40" / 1016 mm	4.75"	3.5 API IF F / 3.5 API IF F	3/8" / .250 - 13	60K - 100K
400-2536	42" / 1067 mm	4.75"	3.5 API IF F / 3.5 API IF F	3/8" / .250 - 13	60K - 100K

\*Nozzles included. See page 81 for optional replacements.

Note: Threaded connection options on page 77 and 79.







## WARTHOG™ HD BACKREAMER

## WARTHOG™ HD BACKREAMER

The Warthog's dynamic cutting structure is designed to reduce drag and use lower torque pressures downhole for superior backreaming efficiency. Its carbide-reinforced Shark teeth carve through everything from hard, compacted soils to sandstone and shale. Along with its box design, allowing for flexibility in setting up ideal configurations, the Warthog features a through-flow shaft to accommodate stacking reamers for increased production.



PART NUMBERS	CUT	SHAFT	DESCRIPTION	NPT/ORIFICE/NOZZLE QTY.	MODEL(S)
400-2537	8" / 203.2 mm	2.75"	2.0 API R F / 20K Tab	1/4" / .188 - 5	9K - 20K
400-2538	10" / 254 mm	2.75"	2.0 API R F / 20K Tab	1/4" / .188 - 8	9K - 20K
400-2539	12" / 304.8 mm	2.75"	2.0 API R F / 20K Tab	1/4" / .188 - 14	9K - 20K
400-2540	14" / 355.6 mm	2.75"	2.0 API R F / 20K Tab	1/4" / .188 - 14	9K - 20K
400-2541	16" / 406.4 mm	2.75"	2.0 API R F / 20K Tab	1/4" / .188 - 17	9K - 20K
400-2542	18" / 457.2 mm	2.75"	2.0 API R F / 20K Tab	1/4" / .188 - 20	9K - 20K
400-2349	8" / 203.2 mm	3.25"	2.38 API R F / 2.38 API R F	1/4" / .188 - 6	16K - 36K

\*Nozzles included. See page 81 for optional replacements.

Note: Threaded connection options on page 77 and 79.

PART NUMBERS	CUT	SHAFT	DESCRIPTION	NPT/ORIFICE/NOZZLE QTY.	MODEL(S)
400-2350	10" / 254 mm	3.25"	2.38 API R F / 2.38 API R F	1/4" / .188 - 9	16K - 36K
400-2351	12" / 304.8 mm	3.25"	2.38 API R F / 2.38 API R F	1/4" / .188 - 15	16K - 36K
400-2352	14" / 355.6 mm	3.25"	2.38 API R F / 2.38 API R F	1/4" / .188 - 15	16K - 36K
400-2353	16" / 406.4 mm	3.25"	2.38 API R F / 2.38 API R F	1/4" / .188 - 18	16K - 36K
400-2354	18" / 457.2 mm	3.25"	2.38 API R F / 2.38 API R F	1/4" / .188 - 21	16K - 36K
400-2355	20" / 508 mm	3.25"	2.38 API R F / 2.38 API R F	1/4" / .188 - 21	16K - 36K
400-2356	24" / 609.6 mm	3.25"	2.38 API R F / 2.38 API R F	1/4" / .188 - 21	16K - 36K
400-2423	8" / 203.2 mm	4.25"	2.88 API R F / 2.88 API R F	1/4" / .188 - 5	40K - 60K
400-2424	10" / 254 mm	4.25"	2.88 API R F / 2.88 API R F	1/4" / .188 - 8	40K - 60K
400-2425	12" / 304.8 mm	4.25"	2.88 API R F / 2.88 API R F	1/4" / .188 - 8	40K - 60K
400-2427	14" / 355.6 mm	4.25"	2.88 API R F / 2.88 API R F	1/4" / .188 - 14	40K - 60K
400-2426	16" / 406.4 mm	4.25"	2.88 API R F / 2.88 API R F	1/4" / .188 - 17	40K - 60K
400-2428	18" / 457.2 mm	4.25"	2.88 API R F / 2.88 API R F	1/4" / .188 - 20	40K - 60K
400-2429	20" / 508 mm	4.25"	2.88 API R F / 2.88 API R F	1/4" / .188 - 20	40K - 60K
400-2430	24" / 609.6 mm	4.25"	2.88 API R F / 2.88 API R F	1/4" / .188 - 20	40K - 60K
400-2431	28" / 711.2 mm	4.25"	2.88 API R F / 2.88 API R F	1/4" / .188 - 20	40K - 60K
400-2432	30" / 762 mm	4.25"	2.88 API R F / 2.88 API R F	1/4" / .188 - 20	40K - 60K
400-2447	12" / 304.8 mm	4.75"	3.5 API I F F / 3.5 API I F F	1/4" / .188 - 8	60K - 100K
400-2448	14" / 355.6 mm	4.75"	3.5 API I F F / 3.5 API I F F	1/4" / .188 - 8	60K - 100K
400-2449	16" / 406.4 mm	4.75"	3.5 API I F F / 3.5 API I F F	1/4" / .188 - 17	60K - 100K
400-2450	18" / 457.2 mm	4.75"	3.5 API I F F / 3.5 API I F F	1/4" / .188 - 17	60K - 100K
400-2451	20" / 508 mm	4.75"	3.5 API I F F / 3.5 API I F F	1/4" / .188 - 20	60K - 100K
400-2452	24" / 609.6 mm	4.75"	3.5 API I F F / 3.5 API I F F	1/4" / .188 - 20	60K - 100K
400-2453	28" / 711.2 mm	4.75"	3.5 API I F F / 3.5 API I F F	1/4" / .188 - 20	60K - 100K
400-2454	30" / 762 mm	4.75"	3.5 API I F F / 3.5 API I F F	1/4" / .188 - 20	60K - 100K
400-2455	34" / 863.6 mm	4.75"	3.5 API I F F / 3.5 API I F F	1/4" / .188 - 26	60K - 100K
400-2456	36" / 914.4 mm	4.75"	3.5 API I F F / 3.5 API I F F	1/4" / .188 - 26	60K - 100K

\*Nozzles included. See page 81 for optional replacements.

Note: Threaded connection options on page 77 and 79.





SOIL CONDITION CHART

KEY ● = Best ○ = Better ○ = Good



## SANDHOG HD BACKREAMER

The Sandhog Backreamer is a triple-action backreamer designed for aggressive cutting, mixing and packing, giving you the best-prepared bore path for pullback in sandy and soft soils. It's strategically engineered to cut the hole to allow the barrel-shaped body to compact true to size and give maximum capacity for fluid flow for product pullback in unstable soil conditions.



PART NUMBERS	CUT	PACK	SHAFT	DESCRIPTION	NOZZLE/QTY.	MODEL(S)
400-2964	6" / 152.4 mm	4	2.75"	2.0 IF / 20K Tab	1/4" / .188 - 8	9K - 20K
400-2965	8" / 203.2 mm	6	2.75"	2.0 IF / 20K Tab	1/4" / .188 - 8	9K - 20K
400-2966	10" / 254 mm	8	2.75"	2.0 IF / 20K Tab	1/4" / .188 - 8	9K - 20K
400-2967	12" / 304.8 mm	10	2.75"	2.0 IF / 20K Tab	1/4" / .188 - 14	9K - 20K
400-2968	6" / 152.4 mm	4	3.25"	2.38 API-R / 20K Tab	1/4" / .188 - 8	16K - 36K
400-2969	8" / 203.2 mm	6	3.25"	2.38 API-R / 20K Tab	1/4" / .188 - 8	16K - 36K
400-2970	10" / 254 mm	8	3.25"	2.38 API-R / 20K Tab	1/4" / .188 - 8	16K - 36K
400-2971	12" / 304.8 mm	10	3.25"	2.38 API-R / 20K Tab	1/4" / .188 - 14	16K - 36K

## SWAB REAMER

The Swab reamer is designed for direct pullback for All Terrain drills in rocky and hard soils. This backreamer directly connects to All Terrain drill pipe without the use of connectors, increasing productivity and jobsite efficiency.

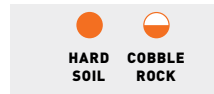

PART NUMBERS	CUT	SHAFT	DESCRIPTION	NPT/ORIFICE/NOZZLE/QTY.	MODEL(S)
400-2614	5.5" / 139.7 mm	3.25"	2.77 M / 20K Tab	1/4" NPT / .100/3	30K
400-2799	5.5" / 139.7 mm	4.375"	2.95 M / 20K Tab	1/4" NPT / .100/3	AT40
400-3066	6.5" / 165.1 mm	4.375"	2.95 M / 20K Tab	1/4" NPT / .100/3	AT40
400-2716	6.5" / 165.1 mm	4.375"	3.25 M / 20K Tab	1/4" NPT / .100/3	AT4020 / AT60
400-2719	6.5" / 165.1 mm	4.375"	3.44 M / 20K Tab	1/4" NPT / .100/3	AT100

\*Nozzles included. See page 81 for optional replacements.



## ROCK MONSTER™ HD BACKREAMER

Engineered to improve longevity in a variety of drilling environments, the Ditch Witch® Rock Monster HD backreamer is equipped with EdgeGuard™ protection that includes strategically placed tungsten carbide disks and patented High Energy Tumbling (HET™) inserts. The Rock Monster HD is designed for smooth cutting downhole and is available in multiple sizes to maximize your effectiveness and productivity when drilling rock.



PART NUMBERS	CUT	IADC	SHAFT	FRONT CONNECTION	REAR CONNECTION	NOZZLE QUANTITY
400-2993	10" / 254 mm	517	3.75"	2.875" API-REG	40K Tab	4
400-3036	12" / 304.8 mm	517	3.75"	2.875" API-REG	40K Tab	4
400-3037	14" / 355.6 mm	537	4.75"	3.5" API-IF	3.5" API-IF	4
400-3038	14" / 355.6 mm	517	4.75"	3.5" API-IF	3.5" API-IF	5
400-3039	16" / 406.4 mm	537	4.75"	3.5" API-IF	3.5" API-IF	5
400-2735	18" / 457 mm	537	4.75"	3.5" API-IF	3.5" API-IF	5
400-2736	20" / 508 mm	537	4.75"	3.5" API-IF	3.5" API-IF	6
400-2737	22" / 559 mm	537	4.75"	3.5" API-IF	3.5" API-IF	6
400-1647	24" / 610 mm	537	4.75"	3.5" API-IF	3.5" API-IF	6

## ROCK MONSTER™ REAMER NOZZLES

PART NUMBERS	DESCRIPTION	ORIFICE SIZE	RETENTION TYPE	COMPATIBLE REAMERS
159-1022	Jet Nozzle	.375	Snap Ring	400-2993
159-1025	Jet Nozzle	.125	Snap Ring	400-2993
159-1026	Jet Nozzle	.25	Snap Ring	400-2993
159-1027	Jet Nozzle	.25	Snap Ring	400-3037, 400-3038, 400-3039, 400-2735, 400-2736, 400-2737, 400-2738
159-1028	Jet Nozzle	.375	Snap Ring	400-3037, 400-3038, 400-3039, 400-2735, 400-2736, 400-2737, 400-2738

Note: Sold in quantities of three.



## EZ BACKREAMER

Designed for direct connections to the EZ connect assembly, this backreamer is a simple, effective and fast-connecting tool for small diameter installations in soft to medium-hard soil conditions.



PART NUMBERS	CUT	SHAFT	DESCRIPTION	NPT/ORIFICE/NOZZLE/QTY.	MODEL(S)
400-2579	6" / 152.4 mm	3.25"	2.00-6 F, EZ2 / 30K Tab	1/4" NPT / .100/3	JT20
400-2584	8" / 203.2 mm	3.25"	2.00-6 F, EZ2 / 30K Tab	1/4" NPT / .100/3	JT20
400-2699	6" / 152.4 mm	3.25"	2.25-6 F, EZ3 / 30K Tab	1/4" NPT / .100/3	JT25 / JT30
400-2700	8" / 203 mm	3.25"	2.25-6 F, EZ3 / 30K Tab	1/4" NPT / .100/3	JT25 / JT30
400-2732	6" / 152.4 mm	3.25"	1.63-6 F, EZ2 / 30K Tab	1/4" NPT / .100/3	JT10

\*Nozzles included. See pg 81 for optional replacement.

Note: Threaded connection options on page 77 and 79.





SOIL CONDITION CHART KEY ●=Best ○=Better ○=Good

## ROCKMASTER® HOLE OPENER

Designed for heavy or solid rock bores, the RockMaster reamer body is available in four reamer body sizes. Features include replaceable Mill Tooth or TCI (Tungsten Carbide Insert) cutters that are field-replaceable and gauge-protected for extended life. Hole diameters range from 6" (152 mm) to 22" (559 mm), depending on the reamer body and cutters used.



PART NUMBERS	CUT	SERIES	SHAFT	DESCRIPTION	MODEL(S)
190-1403	6" / 152.4 mm	TCI	2.75"	2.59 F / 30K Tab	27K - 30K Drills
190-1404	6" / 152.4 mm	MT200	2.75"	2.59 F / 30K Tab	27K - 30K Drills
190-1391	8" / 203.2 mm	TCI	4"	2.59 F / 40K Soc	27K - 40K Drills
190-1392	8" / 203.2 mm	MT200	4"	2.59 F / 40K Soc	27K - 40K Drills
190-1393	10" / 254 mm	TCI	4"	2.59 F / 40K Soc	27K - 40K Drills
190-1394	10" / 254 mm	MT200	4"	2.59 F / 40K Soc	27K - 40K Drills
190-1395	12" / 304.8 mm	TCI	4"	2.59 F / 40K Soc	27K - 40K Drills
190-1396	12" / 304.8 mm	MT200	4"	2.54 F / 40K	27K - 40K Drills
368-380	Body Only	N/A	4"	2.59 F / 40K	27K - 40K Drills
190-1397	10" / 254 mm	TCI	5.75"	3.5 API M / 30K Tab	60K - 100K Drills
190-1398	10" / 254 mm	MT200	5.75"	3.5 API M / 30K Tab	60K - 100K Drills
190-1399	12" / 304.8 mm	TCI	5.75"	3.5 API M / 30K Tab	60K - 100K Drills
190-1400	12" / 304.8 mm	MT200	5.75"	3.5 API M / 30K Tab	60K - 100K Drills
190-1401	14" / 355.6 mm	TCI	5.75"	3.5 API M / 30K Tab	60K - 100K Drills
190-1402	14" / 355.6 mm	MT200	5.75"	3.5 API M / 30K Tab	60K - 100K Drills
368-236	Body Only	N/A	5.75"	3.5 API M / 30K Tab	60K - 100K Drills
190-1405	16" / 406.4 mm	TCI 500	8"	3.27 F / 100K Tab	60K - 100K Drills
190-1406	16" / 406.4 mm	TCI 700	8"	3.27 F / 100K Tab	60K - 100K Drills
190-1407	18" / 457.2 mm	TCI 500	8"	3.27 F / 100K Tab	60K - 100K Drills
190-1408	18" / 457.2 mm	TCI 700	8"	3.27 F / 100K Tab	60K - 100K Drills
190-1409	20" / 508 mm	TCI 500	8"	3.27 F / 100K Tab	60K - 100K Drills
190-1410	20" / 508 mm	TCI 700	8"	3.27 F / 100K Tab	60K - 100K Drills
190-1411	22" / 558.8 mm	TCI 500	8"	3.27 F / 100K Tab	60K - 100K Drills
190-1412	22" / 558.8 mm	TCI 700	8"	3.27 F / 100K Tab	60K - 100K Drills
400-973	Body Only	N/A	8"	3.27 F / 100K Tab	60K - 100K Drills

Note: MT = Mill Tooth and TCI = Tungsten Carbide Inserts

## REPLACEMENT CUTTER SETS

PART NUMBERS	CONE HEIGHT	SERIES	SHAFT	CUT
369-301	1.8"	TCI 500	2.75"	6" / 125.4 mm
369-302	1.8"	MILL	2.75"	6" / 125.4 mm
400-809	1.8"	TCI 600	2.75"	6" / 125.4 mm
400-078	2.3"	TCI 500	4"/5.75"	8/10" / 203.2 / 254 mm
400-079	2.3"	MILL	4"/5.75"	8/10" / 203.2 / 254 mm
400-080	3.2"	TCI 500	4"/5.75"	10/12" / 254 / 304.8 mm
400-081	3.2"	MILL	4"/5.75"	10/12" / 254 / 304.8 mm
400-082	4.1"	TCI 500	4"/5.75"	12/14" / 304.8 / 355.6 mm
400-083	4.1"	MILL	4"/5.75"	12/14" / 304.8 / 355.6 mm
400-810	2.3"	TCI 600	4"/5.75"	8/10" / 203.2 / 254 mm
400-811	3.2"	TCI 600	4"/5.75"	10/12" / 254 / 304.8 mm
400-812	4.1"	TCI 600	4"/5.75"	12/14" / 304.8 / 355.6 mm
400-974		TCI 500	8"	16" / 406.4 mm
400-975		TCI 700	8"	16" / 406.4 mm
400-976		TCI 500	8"	18" / 457.2 mm
400-977		TCI 700	8"	18" / 457.2 mm
400-978		TCI 500	8"	20" / 508 mm
400-979		TCI 700	8"	20" / 508 mm
400-980		TCI 500	8"	22" / 558.8 mm
400-981		TCI 700	8"	22" / 558.8 mm

## CENTERING CONE

PART NUMBERS	SIZE	ALL TERRAIN MODEL(S)	DESCRIPTION	NOZZLE QUANTITY
400-3011	6"	AT30 / AT40	2.88 API R F/M	8
400-3012	8"	AT30 / AT40	2.88 API R F/M	8
400-2998	10"	AT30 / AT40	2.88 API R F/M	8
400-3013	12"	AT30 / AT40	2.88 API R F/M	8
400-3014	14"	AT30 / AT40	2.88 API R F/M	8
400-3015	16"	AT30 / AT40	2.88 API R F/M	8
400-3016	18"	AT30 / AT40	2.88 API R F/M	8
400-3023	10"	AT60 / AT100	3.5 API IF F/M	8
400-3024	12"	AT60 / AT100	3.5 API IF F/M	8
400-3025	14"	AT60 / AT100	3.5 API IF F/M	8
400-3026	16"	AT60 / AT100	3.5 API IF F/M	8
400-3027	18"	AT60 / AT100	3.5 API IF F/M	8

Note: Replaceable nozzles on page 81.





# DURABLE AS THE DRILLS THAT PULL THEM.



A weak link can cripple your entire jobsite. That's why you can't skimp on important components like pullers, swivels and tabs. Ditch Witch® one-piece pullers provide a reliable connection you can count on bore after bore. Our swivels are built to last up to four times longer than aftermarket counterparts. And our pulling tabs are made from hardened steel and tested to perform up to the demanding Ditch Witch standards.

## BIT PULLING ACCESSORIES



PART NUMBERS	DESCRIPTION
369-709	Bit Clevis - JT5 bits only
400-242*	Bit Pull Eye Assembly
400-2668	Pull Tool (small)
906-1828	Shackle 3/8 screw pin anchor
400-2669	Pull Tool with shackle

\*See Bit Page for Application.

## PULLING GRIPS

### WITH SWIVEL

PART NUMBERS	SIZE
185-901	1/4 - 1/2"
185-902	1/2 - 3/4"
185-903	3/4 - 1-1/4"
185-904	1-1/4 - 2"
185-906	2 - 2-3/4"
185-907	2-3/4 - 3-1/2"
185-913	3-1/2 - 4-1/4"
185-914	4-1/4 - 4-3/4"

### WITHOUT SWIVEL

PART NUMBERS	SIZE
185-917	3/4 - 1-1/4"
185-918	1-1/4 - 2"
185-919	2 - 2-3/4"
185-920	2-3/4 - 3-1/2"
185-921	3-1/2 - 4-1/4"

### HEAVY-DUTY PULLING GRIP

PART NUMBERS	SIZE
185-922	3/4 - 1-1/4"
185-923	1-1/4 - 2"
185-924	2 - 2-3/4"
185-925	2-3/4 - 3-1/2"
185-926	3-1/2 - 4-1/4"



## ANCHOR SHACKLES

PART NUMBERS	SIZE	BOLT SIZE	WIDTH	LOAD LIMIT
110-289	5/16"	3/8"	.53"	1K
110-509	1/2"	5/8"	.815"	4K
110-969	5/8"	3/4"	1.065"	6.5K
110-040	3/4"	7/8"	1.25"	9.5K
110-987	7/8"	1"	1.44"	13K
110-847	1"	1-1/8"	1.69"	17K
111-018	1-1/4"	1-3/8"	2.03"	24K
111-019	1-1/2"	1-5/8"	2.375"	34K
369-709	Bit Clevis	1/2"	N/A	
908-1828	3/8"	7/16"	.66"	2K





## SLEEVED PULLERS

PART NUMBERS	SIZE	MIN - MAX ID	SDR RANGE
902-2100	1"	1.050 - 1.200" ID	11 - 17
902-2200	1.25"	1.200 - 1.500" ID	9 - 17
902-2300	1.5"	1.530 - 1.620" ID	11 - 13.5
902-2400	2"	1.900 - 2.050" ID	11 - 13.5
902-2500	2.5"	2.310 - 2.700" ID	11 - 17
902-2600	3"	2.825 - 3.070" ID	11 - 17
902-2700	4"	3.620 - 4.090" ID	11 - 21
902-2800	5"	4.470 - 5.160" ID	11 - 26
902-2900	6"	5.320 - 6.040" ID	11 - 21



## CARROT PULLER

Made of high-quality alloys, carrot pullers are designed for quick and reliable connections. They feature extra thread reliefs that create a clean, precise thread on the pipe to ensure a superior connection.

PART NUMBERS	SIZE	MIN - MAX ID	SDR RANGE
901-0102	.5 - 1"	0.38 - 1.08" ID	9 - 11
901-0105	1"	0.90 - 1.21" ID	7.3 - 17
901-0122	1 - 1.25"	1 - 1.39" ID	9 - 13.5
901-0125	1.25"	1.27 - 1.51" ID	9 - 17
901-0152	1.25 - 1.5"	1.1 - 1.66" ID	7 - 17
901-0150	1.5"	1.52 - 1.67" ID	11 - 17
901-0202	2.0"	1.82 - 2.10" ID	9 - 17



## NON-SLEEVED PULLERS

The economical choice for trenchless installation professionals, Ditch Witch® Non-Sleeved Pullers offer the secure connection you need for pullback in tough downhole conditions. Non-sleeved pullers are made of high-quality alloys and feature a durable pulling eye for reliable performance every time. Like our sleeved puller, non-sleeved pullers can be quickly and easily installed into HDPE, PVC and other types of pipe.

PART NUMBERS	SIZE	MIN - MAX ID	SDR RANGE
902-0010	1"	1.050 - 1.200" ID	11 - 17
902-0101	1.25"	1.200 - 1.500" ID	9 - 17
902-0151	1.5"	1.530 - 1.620" ID	11 - 13.5
902-0201	2"	1.900 - 2.050" ID	11 - 13.5
902-0251	2.5"	2.310 - 2.700" ID	11 - 17
902-0301	3"	2.825 - 3.070" ID	11 - 17
902-0401	4"	3.620 - 4.090" ID	11 - 21
902-0501	5"	4.470 - 5.160" ID	11 - 26
902-0601	6"	5.320 - 6.040" ID	11 - 21
902-0801	8"	7.050 - 7.750" ID	11 - 21
902-1001	10"	8.670 - 9.875" ID	11 - 26
902-1201	12"	10.430 - 11.960" ID	11 - 23.5



## SLIM LINE SWIVELS

Featuring heavy-duty contact bearings and exposed grease fittings for easy application, Ditch Witch® Slim-Line swivels are compatible with a variety of pull tabs, collars and HammerHead® pulling sleeves.

PART NUMBERS	CAPACITY
400-1588	5K Swivel
400-3056	10K Swivel
400-2744	20K Swivel
400-3059	30K Swivel



## THREADED SWIVELS

PART NUMBERS	CONNECTION	CAPACITY
369-195	1.94-4F / 12K Tab	10K
400-111	1.94-4M / 12K Tab	10K
400-112	1.94-4M / 20K Tab	20K
400-236	1.94-4F / 20K Tab	20K
300-1160	1.94-4F / 30K Tab	20K
400-2558	2.38 API R M / 20K Clevis	40K
400-2559	2.38 API R M / 20K Tab	40K
400-2560	2.38 API R M / 30K Clevis	40K
400-2561	2.38 API R M / 30K Tab	40K
400-1390	3.44-4M SS / 30K Tab	40K
400-2562	2.88 API R M / 30K Clevis	60K
400-2563	2.88 API R M / 30K Tab	60K
400-2564	2.88 API R M / 40K Clevis	60K
400-2565	2.88 API R M / 40K Tab	60K
400-2566	3.5 API IF M / 40K Clevis	100K
400-2567	3.5 API IF M / 40K Tab	100K
400-2568	3.5 API IF M / 100K Clevis	100K
400-2569	3.5 API IF M / 100K Tab	100K



## SLEEVED PULLER REPLACEMENT PARTS

REPLACEMENT PART	1" (25 MM) 902-2100	1.25" (32 MM) 902-2200	1.5" (40 MM) 902-2300	2" (50 MM) 902-2400	2.5" (63 MM) 902-2500	3" (75 MM) 902-2600	4" (120 MM) 902-2700	6" (160 MM) 902-2800
Stem	902-2101	902-2201	902-2301	902-2401	902-2401	902-2610	902-2610	902-2901
O-Ring Kit	902-2103	902-2203	902-2303	902-2403	902-2503	902-2603	902-2703	902-2904
Sleeve Assembly	902-2102	902-2202	902-2302	902-2402	902-2502	902-2601	902-2701	902-2902
Jaw Set	902-2114	902-2212	902-2315	902-2414	902-2513	902-2602	902-2713	902-2915
Expander Cone	902-0009	902-0109	902-0158	902-0209	902-0209	902-0302	902-0302	902-0619
Nut	n/a	n/a	n/a	n/a	n/a	2921	2921	2921
Eyebolt	30304	30304	51290	51290	51290	30291	30291	30291

PULLERS, SWIVELS & TABS





## DOUBLE CLEVIS

PART NUMBERS	CONNECTION	CAPACITY
185-935	5K Clevis / 5K Clevis	10K
401-283	20K Clevis / 20K Clevis	20K
300-1164	30K Clevis / 30K Clevis	30K
401-294	100K Clevis / 100K Clevis	40K

## CLEVIS TO TAB

PART NUMBERS	CONNECTION	CAPACITY
368-513	12K Clevis / 12K Tab	10K
368-634	20K Clevis / 20K Tab	20K
369-712	30K Clevis / 20K Tab	20K
300-1157	30K Clevis / 30K Tab	30K
400-748	40K Clevis / 40K Tab	60K
369-971	70K Clevis / 40K Tab	60K
369-972	100K Clevis / 70K Tab	100K



## PULL TAB & PULL CLEVIS

PART NUMBERS	DESCRIPTION	MODEL(S)
369-308	1.21 M / 5K Tab	JT520
369-309	1.31 F / 5K Tab	JT520
400-1432	1.33 F / 5K Tab	JT5
368-352	1.41 M / 12K Tab	JT920 / JT920L / JT921 / JT921S / JT922
400-921	1.88 F / 10K Tab	JT1220M1
401-007	1.88 F / 20K Tab	JT1220M1
369-864	1.94 M / 10K Tab	JT920L / JT1220M1
369-865	1.94 M / 20K Tab	JT920 / JT920L / JT921 / JT921S / JT922 / JT1220M1 / JT1720M1 / JT2020M1
400-2554	2.38 API R M / 20K Tab	16K - 36K
400-2419	2.38 API R M / 30K Tab	16K - 36K
400-760	DS 2.77 M / 30K Tab	AT2720 / AT30
400-803	SS 2.77 M / 30K Tab	AT2720 / AT30 Cobble
400-2555	2.88 API R M / 30K Tab	40K - 70K
400-2518	2.88 API R M / 40K Tab	40K - 70K
401-246	3.25 M / 30K Tab	AT4020 / AT60
400-818	3.25 M / 40K Tab	AT4020 / AT60
400-820	3.25 F / 60K Tab	AT60
369-123	3.27 M / 70K Tab	JT8020M1 / JT100M1
369-122	3.27 F / 70K Tab	JT8020M1 / JT100M1
400-2556	3.5 API IF M / 40K Tab	70K - 100K
400-2519	3.5 API IF M / 100K Tab	70K - 100K
400-583	40K Socket / 30K Tab	3.5" Shaft Reamers
400-704	40K Socket / 40K Tab	JT4020M1 / AT4020
369-854	70K Clevis / 40K Tab	JT4020M1 / JT8020M1 / JT100M1 / JT60
400-781	2.77" 4 DS AT F / 30K	AT30
400-2557*	2.88 API R M / 40K Socket	40K / 60K
400-3121	2.95 M / 40K Tab	AT40

DS = Double Shoulder

SS = Single Shoulder

\* Converts threaded HD reamers to 40K socket, connections and swivels.



## SOCKETS

PART NUMBERS	CONNECTION	CAPACITY
300-1159	40K Socket F / 30K Tab	30K
400-221	40K Socket / 40K Tab	60K





# RUGGED CONSTRUCTION. PRECISION PERFORMANCE. MAXIMUM EFFICIENCY.

Whether manufactured from heat-treated steel or fabricated with carbide inserts, our nozzles can take what the jobsite dishes out, while still regulating and directing fluid flow with precision. Available with varying flows and pressures, we have a nozzle that will help maximize the efficiency of your directional drill in virtually any application.

## BEACON HOUSING & BACKREAMER NOZZLES

PART NUMBERS	THREAD SIZE	ORIFICE SIZE
105-2635	1/8 NPT	Plug
908-0766	1/8 NPT	.155"
159-1006	1/4 NPT	.1"
159-1007	1/4 NPT	.125"
159-1008	1/4 NPT	.188"
159-1009	1/4 NPT	.25"
908-0043	1/4 NPT	.203"
149-200	1/4 NPT	.07"
149-201	1/4 NPT	.1"
149-202	1/4 NPT	.15"
149-203	1/4 NPT	.2"
149-204	1/4 NPT	.25"
906-2673	1/4 NPT	.25"
105-2637	1/4 NPT	Plug
159-1010	3/8 NPT	.125"
159-1011	3/8 NPT	.188"
159-1012	3/8 NPT	.25"
114-002	3/8 NPT	Plug
906-1526	3/8 NPT	.312"





**QUICK.  
CONVENIENT.  
AND EXCLUSIVE  
TO DITCH WITCH®.**



Ditch Witch® quick wrenches and jaws provide an effective way to manually connect and disconnect portions of the drill string. Use them to help you disconnect the drill head from the drill string before attaching a backreamer, or to connect the drill head to the drill string before drilling. We offer a variety of jaw shapes and sizes to accommodate the installation or removal of different types of bits, backreamers and transition subs.

368-533



**WRENCH SET**

PART NUMBERS	DESCRIPTION	SIZE	INCLUDED
368-681	Wrench Handle Assembly	0 - 4,000 ft-lb	
368-533	Vice Handle Assembly	0 - 4,000 ft-lb	
368-761	2 Vice Kit	0 - 4,000 ft-lb	2 Vice
401-229	Wrench Set	0 - 4,000 ft-lb	2 Vice, 1 Flat
369-297	Wrench Set	0 - 4,000 ft-lb	1 Vice, 2 Flat

368-681





# CONNECTIONS YOU CAN COUNT ON.



Ditch Witch® Hydra-Tong provides an effective way to manually connect and disconnect portions of the drill string. Use this system to help you disconnect the drill head from the drill string before attaching a backreamer, or to connect the drill head to the drill string before drilling. We offer a variety of jaw shapes and sizes to accommodate the installation or removal of different types of bits, backreamers and transition subs.

## HYDRA-TONG

Built with a compact design for use in tight quarters, the Hydra-Tong is compatible with a wide range of diameters (from 3-5/8" - 5") and features adjustable slides to reach wide spans. It delivers high torque output while running on a rechargeable 28 volt li-ion battery-operated cordless system.

PART NUMBERS	DESCRIPTION	SIZE
400-2638	Hydra-Tong Assembly	Fits Outside Diameter 3.625" up to 5"
400-2703	Hydra-Tong Assembly (CE)	Fits Outside Diameter 3.625" up to 5"
400-161	Hydra-Tong Jaw Handle	
400-2637	Hydra-Tong Power Supply & Hose Kit	
400-2702	Hydra-Tong Power Supply & Hose Kit (CE)	
105-592	Chain Extension	
110-833	Snapper Pin [3/8" x 2-3/4"]	
150-722	Hydraulic Wrench Cylinder	
178-503	Slide Pin	

Note: CE = 50hz / 240V for battery pack charger.







# HYDRA-TONG

PART NUMBERS	DESCRIPTION
400-161	Jaw Handle
400-889	Chain Tong Assembly
150-4648	Hydra-Tong Hose Assembly
215-2605	28V Battery Charger (CE)
215-2489	28V Battery Charger
215-2507	28V Battery
255-1050	Hydra-Tong Pump Oil

Note: CE = 50hz / 240V for battery pack charger.



# FLAT JAW

PART NUMBERS	DESCRIPTION	SIZE
368-693	Quick Wrench Jaw	1.24"
369-281	Quick Wrench Jaw	1.42"
369-282	Quick Wrench Jaw	1.56"
368-692	Quick Wrench Jaw	1.63"
368-690	Quick Wrench Jaw	2"
368-689	Quick Wrench Jaw	2.1"
368-688	Quick Wrench Jaw	2.25"
368-687	Quick Wrench Jaw	2.35"
368-686	Quick Wrench Jaw	2.4"
369-286	Quick Wrench Jaw	2.5"
400-004	Jaw (1" Thick)	3.25"
368-682	Quick Wrench Jaw	3.75"
369-101	Jaw (1.5" Thick)	3.75"
400-749	Jaw	4.5"
400-1483	Hydra-Tong	4"
400-2644	Hydra-Tong	4.25"

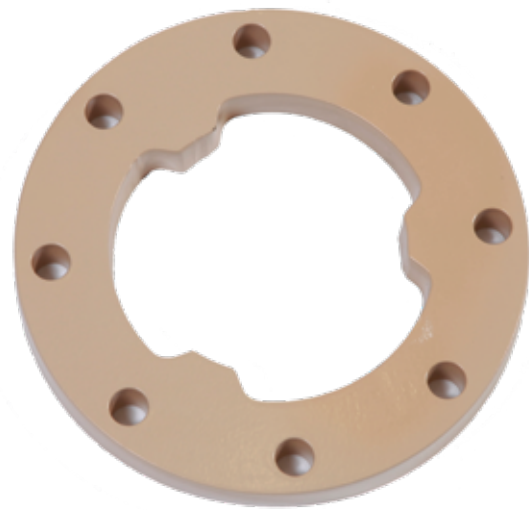
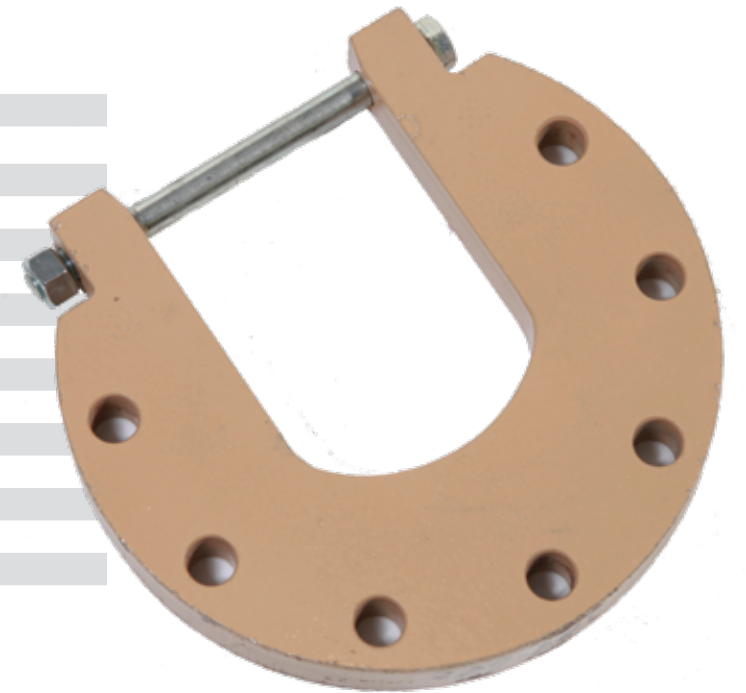

# BIT BLOCK JAW

PART NUMBERS	DESCRIPTION	SIZE
369-795	Tri-Cone	4.75"
400-928	Tri-Cone (1")	5.5"
400-3053	5 Blade PDC	5.5"
400-2981	Piranha	5.5"
400-2982	Tri-Cone (2")	5.5"
401-133	Tri-Cone	6.25"
401-148	Soft Formation	6.25"
400-705	Tri-Cone	6.5"
400-3126	5 Blade PDC	6.5"
400-1119	Soft Formation	6.65"





# INCREASE YOUR PERFORMANCE. INCREASE YOUR PROFITS.



Ditch Witch® provides a variety of new attachments for vacuum excavators, built to increase your performance and productivity. Manufactured to work as hard as you do, these attachments will maximize versatility so you can tackle any jobsite challenge.



Prospector Lance

## HYDRO EXCAVATION

PART NUMBERS	MODEL(S)	DESCRIPTION
150-2624	FX20, FX25, FX30, FXT30, MV800	Prospector™ Nozzle (#3)
150-2625	FX50, FXT50, FX65, FXT65	Prospector Nozzle (#5)
190-2506	FX50, FXT50, FX65, FXT65	Prospector Assembly Lance 48" (#5)
190-2507	FX20, FX25, FX30, FXT30, MV800	Prospector Assembly Lance 48" (#3)
259-1012	All	Prospector Extension 48"
259-1017	All	Wash Wand
150-2630	FX20, FX25, FX30, FXT30, MV800	Prospector Nozzle (#3) Repair Kit
150-2631	FX20, FXT50, FX65, FXT65	Prospector Nozzle (#5) Repair Kit

Note: #3 - 2.7 gpm @ 3,000 psi  
#5 - 4.5 gpm @ 3,000 psi

Prospector Nozzle



259-1017



Prospector Nozzle Repair Kit



259-1012

## AIR EXCAVATION

PART NUMBERS	MODEL(S)	DESCRIPTION
350-4430	FXT30 Air, FXT50 Air, FXT65 Air	Air Saber Assembly
350-4431	FXT30 Air, FXT50 Air, FXT65 Air	Air Saber Extension 36"







## REDUCE DOWNTIME. INCREASE PRODUCTIVITY. PRESERVE EQUIPMENT VALUE.

Failure to perform regular maintenance on equipment is a primary cause of breakdowns, and over time can greatly reduce the value of your machine. Orange Armor® Uptime Kits are designed to help you properly care for your equipment, resulting in consistent productivity, reduction of major repair costs and maximum equipment value.

Each kit contains air, fuel, oil and hydraulic filters, spark plugs, or other parts needed for scheduled maintenance specified for each machine. The larger kits also include basic wear parts and are shipped in lockable, reusable storage trunks at no additional cost.

Make scheduled maintenance easier, more convenient and more affordable with an Orange Armor Uptime Kit customized for your equipment.



Basic Kits



1000 hour kits



### KEY FEATURES/BENEFITS

- Up to 15% savings versus buying parts individually
- Customized for each machine to ensure proper maintenance
- Larger kits include some wear items in addition to maintenance items
- Reusable, lockable storage trunks provided at no additional cost on larger kits

### TRENCHERS

PART NUMBERS	MODEL(S)	KIT TYPE
190-2200	C12	Basic
190-2426	C14	Basic
190-2430	C16 / C16X	Basic
190-2435	C24X	Basic
190-2440	C30X / VP30	Basic
190-1759	RT12	Basic
190-1760	RT16	Basic
190-1761	RT20 / 24	Basic
190-1764	RT45 T2	Basic
190-1766	410SX T4i	Basic
190-1767	420SX T2 / T4i	Basic
190-2103	RT30	Basic
190-2122	RT80Q T4F	1000 HR
190-2142	RT120 T4i	1000 HR
190-2147	RT100 T4i	1000 HR
190-2151	RT45 T4F	1000 HR
190-2152	RT45 T4i	1000 HR
190-2153	RT45 T4F	Basic
190-2154	RT45 T4i	Basic
190-2166	RT120Q T4i	Basic
190-2176	410SX GAS	1000 HR
190-2181	RT55 T4i	1000 HR
190-2151	RT45 T4F	1000 HR

### TRENCHLESS

PART NUMBERS	MODEL(S)	KIT TYPE
190-2100	FM25 / FM25X	Basic
190-2105	FM13V / FM13X	Basic
190-2131	JT5 T4F	1000 HR
190-2172	JT9 / JT10 T4F	1000 HR
190-2174	JT9 / JT10 T4i	1000 HR
190-2112	JT20 / JT20XP T4F / T4i	1000 HR
190-2106	JT25 T3	1000 HR
190-2107	JT25 T4i	1000 HR
190-2138	JT25 / JT30 / AT30 T4F	Basic
190-2136	JT / AT30 T3	1000 HR
190-2137	JT / AT30 T4i	1000 HR
190-2445	JT / AT40 HRC	Basic
190-2447	JT / AT40 LRC	Basic
190-2116	JT / AT100 T3	1000 HR
190-2117	JT / AT100 HRC	Basic
190-2126	JT1220 T4i	1000 HR
190-2173	JT922 T3	1000 HR
190-2191	MR90	1000 HR
190-2156	JT/AT60 T3	1000 HR

### VACUUM EXCAVATORS

PART NUMBERS	MODEL(S)	KIT TYPE
190-2101	FX20	Basic
190-2102	FX25/MV800	Basic
190-2104	FX30/FXT30 T3/T4F (NOT T4i)	1000 HR
190-2161	FX50/FXT50 T4i	1000 HR
190-2162	FX50/FXT50 T4F	1000 HR
190-2186	FX60 T4i	1000 HR
190-2187	FX65 / FXT65 T4 / T4i	1000 HR
190-2454	HX30	Basic
190-2455	HX50	Basic
190-2456	HX75	Basic

### MINI SKID STEERS

PART NUMBERS	MODEL(S)	KIT TYPE
190-1762	SK350	Basic
190-1763	SK650 / SK750 / SK755 T4i	Basic
190-2195	SK600 / SK800	Basic
190-2196	SK850 / SK1050 / SK1550	Basic
190-2197	ST37X	Basic
190-1765	R300	Basic



**CONTACT YOUR LOCAL  
DEALER FOR ALL YOUR  
DITCH WITCH® HDD  
TOOLING NEEDS.**



THE CHARLES MACHINE WORKS, INC. DITCH WITCH WORLDWIDE HEADQUARTERS PERRY, OK 73077-0066 U.S.A.

TOLL FREE 800 654 6481 PHONE 580 336 4402 FAX 580 336 3458 INTERNATIONAL FAX 580 572 3561

FOR INFORMATION ABOUT EASY FINANCING AND TO FIND THE DEALER NEAREST YOU, VISIT [DITCHWITCH.COM](http://DITCHWITCH.COM).