



66

SNOWPLOWS & ACCESSORIES

MORE JOBS.
DONE FASTER.



westernplows.com



“

RISE TO NEW CHALLENGES WHETHER OR NOT THEY HAPPEN DURING REGULAR BUSINESS HOURS

When plowing is your profession, it's up to you to keep the world moving through winter's worst. Less time worrying about your equipment means more time for clearing lots.

The ticking clock controls your paycheck. Minutes wasted are dollars lost. When your schedule is packed and your budget even tighter, the only thing worth your hard-earned money is *better results*.

That's why Western Products builds efficiency into every feature of our plows and spreaders. With more than 70 years of experience behind us, Western Products knows what it takes to conquer all the depths of winter.

Mother Nature may not offer guarantees—but we build a promise into every piece of equipment we make:

MORE JOBS. DONE FASTER.

UNIVERSAL FEATURES

WESTERN® snowplows are designed and manufactured with universal features that are engineered to maximize efficiency, performance and durability.

UltraMount® 2 SNOWPLOW MOUNTING SYSTEM

The exclusive WESTERN UltraMount 2 system is designed for fast and easy installation and removal using a simple mechanical system. It features a robust, one-piece design and is 100% compatible with UltraMount® system mounts and electrical platforms.

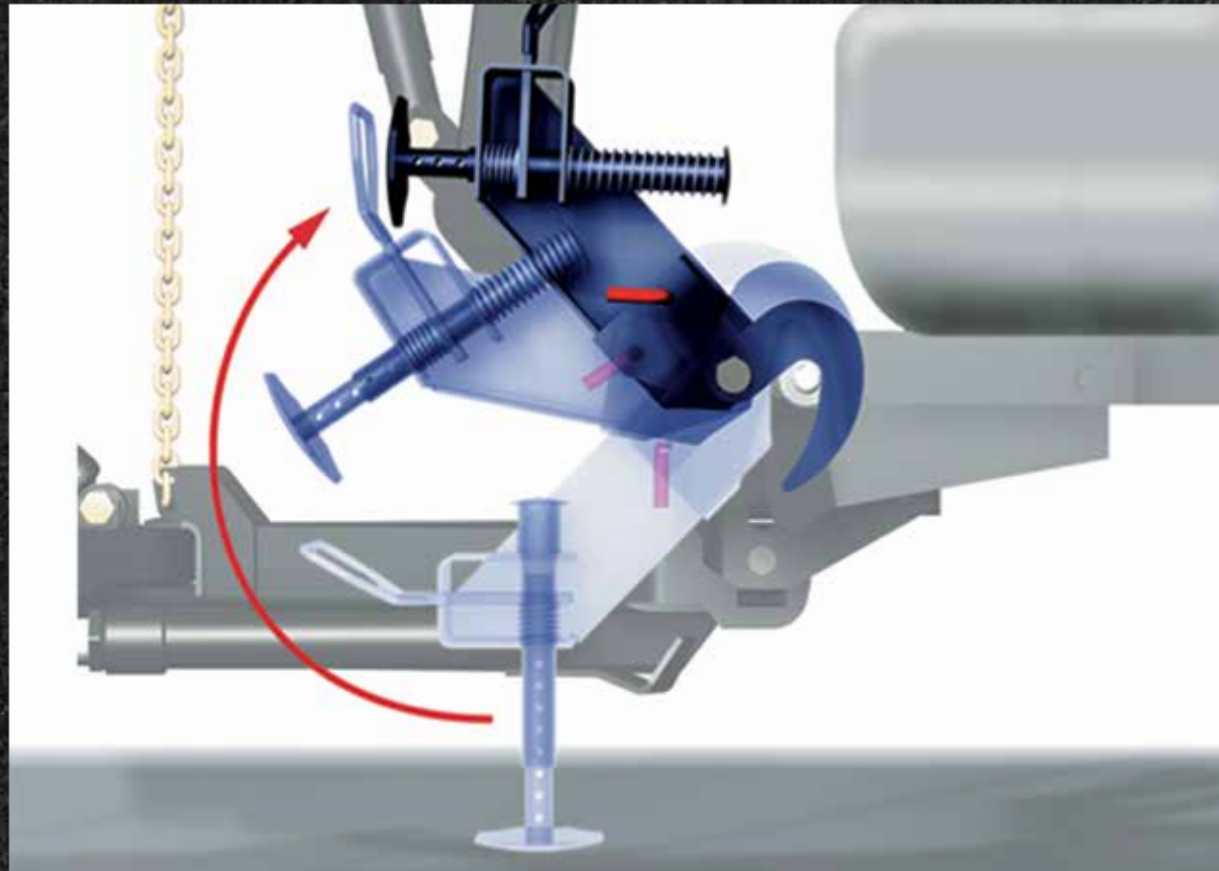

SIMPLE MECHANICAL SYSTEM

No hydraulic or electrical components to fail, and no tools required.

QUICK AND EASY ATTACHMENT

Drive into the extra-wide, flared receiver brackets. Pull the shoe handle up, pull the lock pin and rotate the handle up. Repeat on the other side and plug in the electrical connections.

DURABLE CONSTRUCTION

The entire UltraMount 2 attachment is built upon a robust A-frame/T-frame construction with three-inch square tubing for extra strength and durability.



EXCLUSIVE ROTATING PIVOT BAR

The patented PIVOT BAR keeps the attaching points level even when the blade is not, for accurate drive-in alignment. It removes undue stress on the A-frame pivot bolt and pin, as well as the A-frame itself, reducing the risk of frame failure and breakage of key components. It also allows the blade to pivot while plowing on uneven terrain for a cleaner scrape and more even cutting edge wear.



REMOVABLE RECEIVER BRACKETS

Quickly maximize vehicle ground clearance in the off-season. No tools required.

UNIVERSAL FEATURES

CHAIN LIFT SYSTEM

The mechanical chain lift system offers a variety of performance and reliability advantages over a hydraulic system.



CLEAN SCRAPING PERFORMANCE

The chain lift system creates instantaneous "float" when lowering the blade, enabling it to freely follow the contours of the plowing surface for a cleaner scrape.

HIGHER STACKING

With a chain lift you can stack snow higher because the plow's movement is not restricted by the length of the ram stroke like on cylinder lift systems.

RELIABLE

With the simple, mechanical chain lift design, there are fewer hydraulic and electrical components to worry about, so you can count on long-life dependability.

Excludes HTS™ plow, DEFENDER™ plow and IMPACT™ UTV plows.



ULTRAFINISH™ BAKED-ON POWDER COAT

The ULTRAFINISH baked-on powder coat with epoxy primer is standard on all WESTERN® plows, providing outstanding protection against wear and rust. Each WESTERN plow goes through an automated pretreatment process and multistage prewash to prepare the plow surface for optimum coating adhesion. Our durable epoxy primer improves corrosion resistance and enhances powder coat adhesion. Robotic guns ensure precise, consistent powder coat coverage. The final baking process seals the long-lasting, hard-as-nails WESTERN red coat. The result is a state-of-the-industry finish that will provide superior protection for your plow, season after season.



UNIVERSAL FEATURES



FLEET FLEX ELECTRICAL SYSTEM

The FLEET FLEX electrical system provides true fleet interchangeability. The same CabCommand hand-held or joystick control can operate any UltraMount® and UltraMount® 2 mounted plow on any truck at any time.

Excludes DEFENDER™ plow and IMPACT™ UTV plows.



SECURITY GUARD™ ANTI-THEFT SYSTEM

The exclusive WESTERN® SECURITY GUARD snowplow anti-theft system is a safe and secure way to electronically lock your snowplow when it is detached from your truck. Unlike physical locks that can easily be cut or removed, the system provides a deterrent against theft by allowing you to electronically lock the snowplow's hydraulic functions, rendering your plow inoperable to unauthorized users.



ISOLATION MODULE

This advanced snowplow light and electrical system features improved electrical pins in the harness plugs for trouble-free connections. An underhood module improves system life and complies with OEM requirements. No toggle switch is needed to change from vehicle to plow lights.



RELIABLE HYDRAULICS

We manufacture our own hydraulic components to ensure the highest standards of quality and reliability, so that you get a hydraulic system that's not only fast and responsive, but that's built to last season after season. All critical hydraulic components are fully enclosed for protection from the elements.



UNIVERSAL CONTROLS

Choose between a CabCommand hand-held control with push buttons or a joystick control, based on operator preference. For efficient, precise and intuitive blade control while plowing, both controls feature power "on" and "float" LED lights, backlighting for night operation and plug-in connector for easy removal. Additional features include programmable "soft-stop," "one-touch" float, built-in SECURITY GUARD anti-theft system and plug-in connector for easy removal.



PREPUNCHED BLADES FOR ACCESSORIES

Plow blades are prepunched for easy installation of accessories, providing a custom fit. The prepunched holes also prevent damage to the powder coat that can sometimes occur when installing an accessory.



WESTERN NIGHTHAWK™ HEADLAMPS

With WESTERN truck plows, you have a choice between LED or dual-halogen headlamps. Dual-halogen headlamps provide a high-performing, economical solution, while the LED headlamps offer premium features and unprecedented performance. See pages 8-9 for more information.

NIGHTHAWK™ LED HEADLAMPS



CLEAR AS DAY.

A job's not done until it's done right. That's why the WESTERN® NIGHTHAWK™ LED headlamps are designed with premium features that provide unprecedented performance and superior visibility. Featuring exclusive EdgeView™ technology, the NIGHTHAWK LED headlamps provide operators with the safest all-around view of the plow's operating environment. When the headlamps are in low-beam mode, the LED lights provide a flat, even, ultra-wide, ultra-bright LED light pattern for superior visibility while also helping to reduce eye fatigue. When in high-beam mode, operators can see further down the road and experience a clearer view of upcoming hazards and the plowing environment. See a job well done—clear as day—at any hour.

EXCLUSIVE EDGEVIEW TECHNOLOGY

The EdgeView technology design features a dedicated lens and LED bulb that directs light through the outer edge of each headlamp. This provides a full 180 degrees of light visibility, illuminating the plow from edge to edge, for the best all-around view of the plow's operating environment.

100% LED PERFORMANCE

The WESTERN NIGHTHAWK LED headlamps offer 100% LED performance, which means every single bulb inside of the headlamps is an LED bulb. These LEDs provide up to two times the light output of halogens and have a much longer life expectancy for long-lasting performance.

SOLID OPTICS

Enhanced solid optic elements place light exactly where it needs to be, rather than relying on reflectors to aim the light as with many other halogen and LED lamps. This allows for optimized light projection which has been engineered specifically to improve poor visibility in inclement weather.

INTUITIVE HEATING SYSTEM

Automatically senses temperature on the lens and activates heating elements when necessary to prevent snow and ice buildup, keeping the headlamps at full illumination and you plowing ahead.

ADVANCED LENS DESIGN

The forward-sloped lens is specially designed without a bezel to ensure it remains clean and free from ice buildup, and you can remain in the cab of your truck.

ENGINEERED AND TESTED FOR DURABILITY

The NIGHTHAWK LED headlamps are designed with a robust, two-stud mounting bracket that helps hold the headlamps firmly in place. They are tested to withstand plowing in extreme temperatures, vibration, impact, water submersion, corrosion and shock.

UPGRADE EXISTING TRUCK PLOWS

The new NIGHTHAWK LED headlamps are available as an option to upgrade existing WESTERN truck plows. To verify vehicle compatibility, be sure to check our online Quick Match program for all of the most up-to-date vehicle applications.

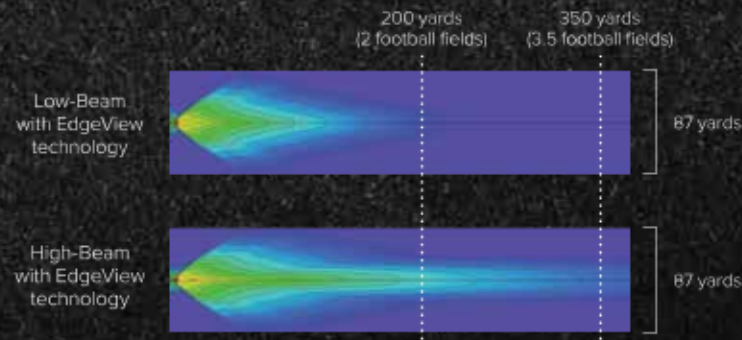

NIGHTHAWK™ DUAL-HALOGEN HEADLAMPS



PREDATORY PERFORMANCE.

When it's time for you and your WESTERN® snowplow to clear the way, you need to see the path ahead. NIGHTHAWK™ dual-halogen headlamps light up the road with brighter performance and greater reach than traditional halogen headlamps, keeping you safe and on the job. The cold never stopped your plow and neither should the dark.

LOW AND HIGH BEAM PERFORMANCE

The low-beam pattern puts more light down immediately in front of the plow, helping to light up the operating environment when plowing.

The high-beam pattern throws light down the road, making it easier for late-night operators to see road hazards while travelling between jobs.

STATE-OF-THE-ART REFLECTIVE OPTICS

NIGHTHAWK dual-halogen headlamps feature reflective optics that are engineered specifically for low-beam and high-beam modes. The dual-cavity design means each mode can provide the optimal light spread and throw, for a smooth, wide light beam pattern with minimal glare, no matter which mode you are in.

MINIMIZE ICE BUILDUP

Halogen headlamps are known to generate heat and as a result, minimize the buildup of snow and ice on the lens.

LENS DESIGN

With the NIGHTHAWK dual-halogen headlamps, a contoured lens and housing helps prevent beading and sheds moisture that can be caused by thawed snow and ice.

ENGINEERED AND TESTED FOR DURABILITY

The NIGHTHAWK dual-halogen headlamps are designed with a robust, two-stud mounting bracket that helps hold the headlamps firmly in place. They are tested to withstand plowing in extreme temperatures, vibration, impact, water submersion, corrosion and shock.

DUAL H9/H11 HALOGEN BULBS

The bulbs have an average life of 1,500 hours and are easy to replace through a simple, three-screw, bulb-access cover.

PUSH THROUGH THE DEPTHS OF WINTER.

The rugged MVP 3™ v-plow gives you all the power, productivity and performance you need for commercial snowplowing. With extreme flared wings, up to 45" on the heavy-duty 10'6" model, and double-acting cylinders, the MVP 3 v-plow has earned its reputation as a reliable plow by consistently delivering on what matters most—getting more jobs done faster.

T-FRAME DESIGN

T-frame provides added strength and allows blade-pitch adjustment to reduce uneven cutting edge wear.

LIFT RAM

1 3/4"-diameter lift ram for more lifting power.

STRUCTURAL REINFORCEMENT

Six vertical ribs on the 7'6" models and eight on the 8'6", 9'6" and 10'6" models, combined with the exclusive WESTERN® POWER BAR, provide exceptional torsional strength and rigidity, eliminating blade twisting.



“

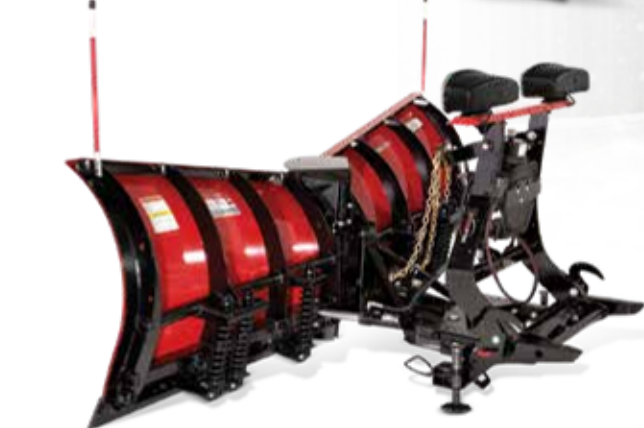

ULTRALOCK DOUBLE-ACTING CYLINDERS

This standard feature locks the wings together to easily maneuver the plow as a straight blade. The double-acting cylinders also hold the wings firmly in place for clean, efficient back dragging.

STEEL CENTER-GAP COVER

For the cleanest pass in any position, the MVP 3 v-plow has a snow-control deflector over the center hinge to help prevent snow from being lost over the top.

MOLDBOARD AVAILABILITY

Powder Coated or Stainless Steel: 7'6", 8'6", 9'6" and 10'6" widths
High-Density Polyethylene: 8'6" and 9'6" widths
See pages 4–7 for all universal snowplow features.



TRIP-EDGE PROTECTION

Each blade features independent trip-edge protection in all configurations—V, scoop or straight—to keep snow in front of the blade.

STANDARD CUTTING EDGE

A 6" high-carbon steel cutting edge comes standard, reducing wear and extending the life of the blade.

HIGH-STRENGTH STEEL BASE CHANNEL

Provides extra support along the bottom of the plow blade.

ACCESSORIES

Poly Cutting Edge | Carbide Cutting Edge
1/2" and 5/8" Steel Cutting Edges | Back Drag Edge*
Curb Guards | Plow Wings | Shoe Kits | Blade Stops
Rubber Snow Deflectors

Consult your local WESTERN® dealer or westernplows.com for accessory compatibility and availability.

*Not compatible with shoe kits and curb guards on v-plows

10'6" HEAVY-DUTY FEATURES

- **BLADE CONSTRUCTION**
Thicker moldboards and a more robust base angle with additional hinge points.
- **HEAVY-DUTY T-FRAME**
Features a solid, one-piece construction from front to back and an oscillating pivot bar.
- **LARGER ANGLE RAMS**
Heavy-duty, 2" angle rams quickly move the snowplow in any direction.
- **STANDARD BLADE ANGLE STOPS**
Designed to transfer extreme impacts throughout the blade's structure and reduce stress on the hydraulic rams.
- **STANDARD CURB GUARDS**
Constructed of abrasion-resistant material to protect the outer edge of the plow from wear when plowing along sidewalks and curbs.

TAKE ON MORE.

Like all WESTERN® products, the MVP PLUS™ v-plow is built for efficiency, durability and performance—but it also gives you the added level of productivity that only a v-plow can achieve, letting you cut through deep banks and clear more snow in fewer passes.

T-FRAME DESIGN

T-frame provides added strength and allows blade-pitch adjustment to reduce uneven cutting edge wear.

STRUCTURAL REINFORCEMENT

Six vertical ribs on the 7'6" models and eight on the 8'6" and 9'6" models, combined with the exclusive WESTERN POWER BAR, provide exceptional torsional strength and rigidity, eliminating blade twisting.

CENTER PIN AND HINGE

A 1"-diameter steel center pin resides within a two-connection-point hinge, keeping the wings tight for optimal performance.

ULTRALOCK DOUBLE-ACTING CYLINDERS

This standard feature locks the wings together to easily maneuver the plow as a straight blade. The double-acting cylinders also hold the wings firmly in place for clean back dragging.

STEEL CENTER-GAP COVER

For the cleanest pass in any position, the MVP PLUS™ v-plow has a snow control deflector over the center hinge to help prevent snow from being lost over the top.

TRIP-EDGE PROTECTION

Each blade features independent trip-edge protection in all configurations—V, scoop or straight—to keep snow in front of the blade.

STANDARD CUTTING EDGE

A 6" high-carbon steel cutting edge comes standard, reducing wear and extending the life of the blade.

HIGH-STRENGTH STEEL BASE CHANNEL

Provides extra support along the bottom of the plow blade.

AVAILABLE IN POLY AND STEEL

Available in ¼" high-density polyethylene or 14-gauge powder coated steel. The durable poly blade provides a slick surface for enhanced snow-rolling action and a maintenance-free surface. The steel blade features our high-quality ULTRAFINISH™ powder coated surface.

ACCESSORIES

Poly Cutting Edge | Carbide Cutting Edge
½" and ⅝" Steel Cutting Edges
Back Drag Edge* | Curb Guards
Plow Wings | Shoe Kits | Blade Stops
Rubber Snow Deflector

Consult your local WESTERN® dealer or westernplows.com for accessory compatibility and availability.

*Not compatible with shoe kits and curb guards on v-plows.

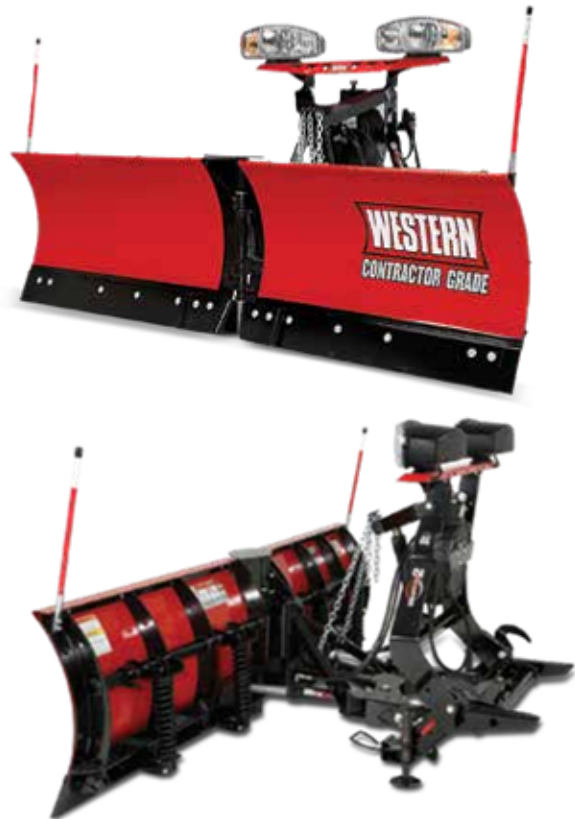

MOLDBOARD AVAILABILITY

Powder Coated Steel: 7'6", 8'6" and 9'6" widths
High-Density Polyethylene: 7'6", 8'6" and 9'6" widths
See pages 4–7 for all universal snowplow features.



Photo may be shown with optional accessories.

EFFICIENCY COMES FROM FLEXIBILITY.

Adapt to whatever the weather throws your way with the WESTERN® WIDE-OUT™* and WIDE-OUT™ XL adjustable wing snowplows. Offered in two blade sizes, the WIDE-OUT XL model extends from 8'6" to 11' in straight blade mode, making it the widest WESTERN plow for truck applications. The plows are our tallest winged plows at 31" and feature independently controlled, flared wings that retract at the push of a button to maneuver in smaller and tighter areas.

HYDRAULIC WING EXTENSIONS

Independently position each wing to maximize blade width and move more snow. Wings slide laterally across a structurally reinforced slide box.

FLARED WINGS FOR EFFICIENCY

The WIDE-OUT plows feature flared wings as tall as 36" to maximize snowplowing efficiency and aggressively cast snow further while windrowing.

STRUCTURAL REINFORCEMENT

Six vertical ribs—eight on the XL model—a heavy-duty quadrant and a dual WESTERN POWER BAR provide exceptional torsional strength and rigidity across the entire back of the plow blade, eliminating blade twisting.

TRIP BLADE AND WING PROTECTION

Four heavy-duty coil springs protect your plow and truck by allowing the whole blade to trip when striking obstacles. The wings of the snowplow will trip in any position as well, including scoop.

WIDE-OUT™ WIDE-OUT™ XL

THE WESTERN® WIDE-OUT™ AND WIDE-OUT™ XL ARE FOUR PLOWS IN ONE.

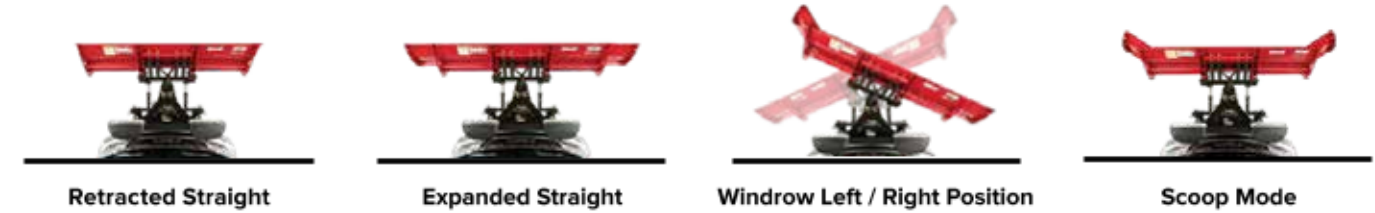

STANDARD CUTTING EDGES

The 6" standard, high-carbon steel cutting edge on the moldboard and wings ensures a clean scrape on every pass while reducing wear and extending the life of the blade.

HIGH-STRENGTH STEEL BASE CHANNEL

Provides extra support along the bottom of the plow blade.

HEAVY-DUTY SLIDE BOX

Structurally reinforced slide box is constructed with 3/16" heavy-grade steel.

ACCESSORIES

Back Drag Edge | Rubber Snow Deflector Shoe Kits | Poly Moldboard Cutting Edge Poly Wing Cutting Edge | Carbide Moldboard Cutting Edge | 5/8" Steel Cutting Edge Shock Absorber

LIFT RAM

1 3/4"-diameter lift ram for more lifting power.

Consult your local WESTERN dealer or westernplows.com for accessory compatibility and availability.

*All product features and specifications listed in this brochure apply to WIDE-OUT snowplows with serial numbers beginning with 180210 and higher



MOLDBOARD AVAILABILITY

Powder Coated Steel:
8' model extends to 10' in straight and 8'10" in scoop
8'6" model extends to 11' in straight and 9'10" in scoop
See pages 4-7 for all universal snowplow features.

HEAD OF ITS CLASS.

Get all of the benefits of a winged plow with the simple control of a straight blade with the WESTERN® PRODIGY™ multi-position wing snowplow. The wings automatically adjust to provide the most efficient plowing configuration for the job. This model adds versatility to your fleet without spending time training operators on how to use new equipment, keeping productivity and profitability high.

AUTOMATICALLY ADJUSTING WINGS

Wings automatically adjust into scoop or windrow when you change the plowing angle with the control.

STRUCTURAL REINFORCEMENT

Six vertical ribs and the exclusive WESTERN POWER BAR provide exceptional strength and rigidity across the entire back of the plow blade. Two additional ribs on each wing provide extra reinforcement.

STRAIGHT BLADE CONFIGURATION

When the job calls for a large straight blade, the wings can be pinned into a 9'8" straight blade configuration.

TRIP BLADE AND WING PROTECTION

Four heavy-duty coil springs allow the whole blade to trip if an obstacle is struck. Wing protection is provided by heavy-duty coil springs and the cable assembly, which automatically return the wings to scoop position.

PRODIGY™

WESTERN® PRODIGY™ PLOWING CONFIGURATIONS.



Straight-ahead scoop mode

Angled right for windrowing

Angled left for windrowing

STANDARD CUTTING EDGE

The 6" standard, high-carbon steel cutting edge on the moldboard and wings ensures a clean scrape on every pass while reducing wear and extending the life of the blade.

ACCESSORIES

Back Drag Edge | Rubber Snow Deflector Shoe Kit | Shock Absorber

Consult your local WESTERN dealer or westernplows.com for accessory compatibility and availability.

HIGH-STRENGTH STEEL BASE CHANNEL

Provides extra support along the bottom of the plow blade.



MOLDBOARD AVAILABILITY

Powder Coated Steel:
8'7" in scoop mode and 7'10" fully angled
See pages 4-7 for all universal snowplow features.

MAKE SHORT WORK OUT OF ANY JOB.

Make the most of the Class 4 to 6 trucks in your fleet with a plow that stands up to the demands of heavy-duty commercial and light municipal snowplowing. The WESTERN® PRO PLUS® HD snowplow lets you make short work of large parking lots and local streets. Forget business cards—distinguish yourself with the clean pavement you leave behind when using our heaviest-duty plow.

REINFORCED FOR CLASS 6 POWER

Eight vertical ribs provide structural reinforcement, ensuring proper alignment and reducing stress on the overall plow assembly.

HEAVY-DUTY 10' STRAIGHT BLADE

The 34"-tall, 11-gauge, powder coated steel moldboard is 10' wide and designed to stand up to the extra demands of heavy-duty commercial and light municipal snowplowing.

LIFT RAM

1 ¾"-diameter lift ram for more lifting power.

STANDARD CUTTING EDGE

Equipped with a 6" high-carbon steel cutting edge to reduce wear and extend the life of the blade, the PRO PLUS® HD snowplow ensures a clean scrape on every pass.

TRIP BLADE PROTECTION

Six heavy-duty coil springs protect your plow and truck by allowing the whole blade to trip when striking obstacles. Dual shock absorbers reduce jarring and soften the blade return when tripping occurs, extending the life of your truck and plow.

ACCESSORIES

Shoe Kits | Rubber Snow Deflectors
Blade Stops | Carbide Cutting Edge
5/8" Steel Cutting Edge

Consult your local WESTERN® dealer or westernplows.com for accessory compatibility and availability.



MOLDBOARD AVAILABILITY

Powder Coated Steel: 10' width
See pages 4–7 for all universal snowplow features.

MAKE YOUR **MARK.**

Give winter all you've got with the WESTERN® PRO PLUS® snowplow. Designed to fit a wide range of vehicles, this rugged straight blade is the ultimate tool for the toughest commercial operations.



STRUCTURAL REINFORCEMENT

Eight vertical ribs, a heavy-duty quadrant and the exclusive WESTERN POWER BAR provide exceptional torsional strength and rigidity, eliminating blade twisting even under the most brutal conditions.

HIGH-STRENGTH STEEL BASE CHANNEL

Provides extra support along the bottom of the plow blade.

HIGH-STRENGTH RECTANGULAR TUBE QUADRANT

Built to withstand season after season of commercial use.

A-FRAME CONSTRUCTION

The 3" square tubing provides strength and durability.

PIVOT BOLT

The 1"-diameter pivot bolt secures the plow in place, ensuring proper alignment and reducing stress on the overall plow assembly.

TRIP BLADE PROTECTION

Four heavy-duty coil springs protect your plow and truck by allowing the whole blade to trip when striking obstacles. Dual shock absorbers reduce jarring and soften the blade return when tripping occurs, extending the life of your truck and plow.

STANDARD CUTTING EDGE

The 6" standard, high-carbon steel cutting edge on the moldboard and wings ensures a clean scrape on every pass while reducing wear and extending the life of the blade.

ACCESSORIES

Curb Guards | Plow Wings
Rubber Snow Deflectors | Back Drag Edge
Poly Snow Deflector | Carbide Cutting Edge*
5/8" Steel Cutting Edge*

Consult your local WESTERN® dealer or westernplows.com for accessory compatibility and availability.

*Fits the 9' model only



MOLDBOARD AVAILABILITY

Powder Coated Steel: 8', 8'6" and 9' widths
See pages 4-7 for all universal snowplow features.

TAKE “PROFESSIONAL” TO THE NEXT LEVEL.

With customers counting on you, it's time to invest in a plow you can trust. There's a good reason the WESTERN® PRO-PLOW® Series 2 snowplow remains one of the best-selling straight blades in the business.

AVAILABLE IN POLY AND STEEL

The 29"-tall moldboard comes in both high-density polyethylene and powder coated steel. The durable 7'6" and 8' poly blades provide a slick surface for enhanced snow-rolling action and a maintenance-free surface. The 7'6", 8' and 8'6" steel blades feature our high-quality ULTRAFINISH™ powder coat surface.

STRUCTURAL REINFORCEMENT

Seven vertical ribs provide structural reinforcement for exceptional torsional strength and rigidity, eliminating blade twisting.

HIGH-STRENGTH STEEL BASE CHANNEL

Provides extra support along the bottom of the plow blade.

PIVOT BOLT

The 1"-diameter pivot bolt secures the plow in place, ensuring proper alignment and reducing stress on the overall plow assembly.

STANDARD BLADE SHOES

Blade shoes help to extend cutting edge and base angle life when plowing rough surfaces.

TRIP BLADE PROTECTION

Four heavy-duty coil springs protect your plow and truck by allowing the whole blade to trip when striking obstacles. Dual shock absorbers reduce jarring and soften the blade return when tripping occurs, extending the life of your truck and plow.

STANDARD CUTTING EDGE

The WESTERN® PRO-PLOW® Series 2 snowplow comes standard with a 6" high-carbon steel cutting edge to provide increased wear resistance and clean scrape.

RUBBER SNOW DEFLECTOR

The rubber snow deflector comes standard on poly moldboard models to help keep snow off of your windshield while plowing. It is available as an accessory for the powder coated steel models.

ACCESSORIES

Back Drag Edge | Curb Guards
Poly Snow Deflector | Rubber Snow Deflector
½" Steel Cutting Edge | Rubber Cutting Edge

Consult your local WESTERN dealer or westernplows.com for accessory compatibility and availability.



MOLDBOARD AVAILABILITY

Powder Coated Steel: 7'6", 8' and 8'6" widths
High-Density Polyethylene: 7'6" and 8' widths
See pages 4-7 for all universal snowplow features.

PRO-PLOW® SERIES 2



Photo may be shown with optional accessories.

STRIKE THE RIGHT BALANCE.

Get pro performance without an ounce of wasted weight. The WESTERN® MIDWEIGHT™ snowplow features professional grade reinforcement to push the boundaries of “light commercial work.”

AVAILABLE IN POLY AND STEEL

The 27"-tall moldboard comes in both high-density polyethylene and powder coated steel. The durable 7'6" poly blade provides a slick surface for enhanced snow-rolling action and a maintenance-free surface, while the 7'6" steel blade features our high-quality ULTRAFINISH™ powder coat surface.

STRUCTURAL REINFORCEMENT

Six vertical ribs and the exclusive WESTERN POWER BAR provide unmatched structural reinforcement, delivering exceptional torsional strength and rigidity, eliminating blade twisting.

HIGH-STRENGTH STEEL BASE CHANNEL

Provides extra support along the bottom of the plow blade.

PIVOT BOLT

The 1"-diameter pivot bolt secures the plow in place, ensuring proper alignment and reducing stress on the overall plow assembly.

TRIP BLADE PROTECTION

The two-spring trip blade protects your snowplow and truck when striking hidden obstacles. Elastomeric bumpers reduce jarring and soften the blade return when tripping occurs, extending the life of your truck and plow.

STANDARD CUTTING EDGE

A 6" high-carbon steel cutting edge comes standard, reducing wear and extending the life of the blade.

ACCESSORIES

Back Drag Edge | Curb Guards | Shoe Kit
Poly Snow Deflector | Rubber Snow Deflector

Consult your local WESTERN® dealer or westernplows.com for accessory compatibility and availability.



MOLDBOARD AVAILABILITY

Powder Coated Steel: 7'6" width

High-Density Polyethylene: 7'6" width

See pages 4-7 for all universal snowplow features.



PUT YOUR **HALF-TON TO WORK.**

Perfect for contractors and homeowners, the WESTERN® HTS™ snowplow is a full-size, full-featured plow designed for lighter half-ton, four-wheel-drive trucks. Engineered for strength and weight, this plow is ideal for personal and light commercial applications such as driveways, small commercial lots and parking spaces.



STRUCTURAL REINFORCEMENT

Six vertical ribs and the exclusive WESTERN POWER BAR provide unmatched structural reinforcement, delivering exceptional torsional strength and rigidity, eliminating blade twisting.

HIGH-STRENGTH STEEL BASE CHANNEL

Provides extra support along the bottom of the plow blade.

PIVOT BOLT

The 1"-diameter pivot bolt secures the plow in place, ensuring proper alignment and reducing stress on the overall plow assembly.

SCRAPE LOCK

Hydraulically holds the blade down for more efficient scraping and clean back dragging.

TRIP BLADE PROTECTION

The two-spring trip blade protects your snowplow and truck when striking hidden obstacles. Elastomeric bumpers reduce jarring and soften the blade return when tripping occurs, extending the life of your truck and plow.

UltraMount® SNOWPLOW MOUNTING SYSTEM

Designed for fast and easy installation and removal using a simple mechanical system. The UltraMount features a robust one-piece design and is 100% compatible with UltraMount® 2 system mounts and electrical platforms.

STANDARD CUTTING EDGE

The 6" standard, high-carbon steel cutting edge on the moldboard and wings ensures a clean scrape on every pass while reducing wear and extending the life of the blade.

ACCESSORIES

Back Drag Edge | Curb Guards
Shoe Kit | Rubber Snow Deflector
3/8" Steel Cutting Edge

Consult your local WESTERN® dealer or westernplows.com for accessory compatibility and availability.



MOLDBOARD AVAILABILITY

Powder Coated Steel: 7'6" width
See pages 4-7 for all universal snowplow features.

CLEAR YOUR PROPERTY LIKE A PRO.

Defend your driveway from the deepest drifts with the WESTERN® DEFENDER™ compact snowplow. Ideal for midsized pickups and SUVs, this plow knows a thing or two about how to get things done—and done right.

HIGH-STRENGTH CONSTRUCTION

Built with high-strength, low-alloy steel that is stronger and lighter than conventional steel, the DEFENDER snowplow is protected by the long-lasting ULTRAFINISH™ baked-on powder coat.

STRUCTURAL REINFORCEMENT

Six vertical ribs deliver exceptional torsional rigidity, eliminating blade twisting.

TRIP BLADE PROTECTION

The two-spring trip blade protects your snowplow and truck when striking hidden obstacles. Elastomeric bumpers reduce jarring and soften the blade return when tripping occurs, extending the life of your truck and plow.

HIGH-STRENGTH STEEL BASE CHANNEL

Provides extra support along the bottom of the plow blade.

SCRAPE LOCK

Hydraulically holds the blade down for more efficient scraping and clean back dragging.

EASY ON / EASY OFF

Simple mechanical attaching system makes attaching and detaching your plow quick and easy.

GROUND CLEARANCE

When the plow is not in use, quickly maximize vehicle ground clearance with the removable receiver brackets. No tools required.

PIVOT BOLT

The 1"-diameter pivot bolt secures the plow in place, ensuring proper alignment and reducing stress on the overall plow assembly.

STANDARD CUTTING EDGE

A 5" high-carbon steel cutting edge comes standard, reducing wear and extending the life of the blade.

ACCESSORIES

3/8" Steel Cutting Edge | Poly Cutting Edge
Rubber Snow Deflector | Curb Guards
Shoe Kit

Consult your local WESTERN® dealer or westernplows.com for accessory compatibility and availability.



MOLDBOARD AVAILABILITY

Powder Coated Steel: 6'8" and 7'2" widths
See pages 4-7 for all universal snowplow features.



Photo may be shown with optional accessories.

WESTERNIZE YOUR UTV.

Winter knows no limits—which means you shouldn't either. Built exclusively for utility vehicles, WESTERN® IMPACT™ UTV snowplows are professional-grade plows built to go anywhere that demands WESTERN-grade performance. Constructed from high-strength, low alloy steel components, both models feature an easy-on/easy-off UTV mounting system and removable receiver brackets for exceptional ground clearance. IMPACT UTV plows feature Scrape Lock for clean scraping and back dragging.

STRAIGHT BLADE

- 6'-wide, 14-gauge powder coated steel moldboard.
- Four vertical ribs for strength and durability.
- 5" high-carbon steel cutting edge comes standard, reducing wear and extending the life of the blade.
- Trip blade protection protects your plow and UTV by allowing the whole blade to trip when encountering hidden obstacles.



V-PLOW BLADE

- 6'-wide, flared v-plow easily adapts to handle 5' sidewalks and gates in angle, scoop or V position.
- Six vertical ribs and our proven T-frame design provide added strength and reinforcement.
- UltraLock double-acting cylinders lock the wings together to maneuver the plow as a straight blade and hold wings firmly in place for clean back dragging.
- 5" high-carbon steel cutting edge comes standard, reducing wear and extending the life of the blade.
- Each blade features independent trip-edge protection in all configurations, whether in V, scoop or straight, to keep snow in front of the blade.



ACCESSORIES

Rubber Snow Deflectors | Poly Cutting Edges
Shoe Kits | Light Bar Kit | Curb Guards (straight blade only)
Plow Wings (v-plow only) | Blade Stop Kit (v-plow only)

Consult your local WESTERN dealer or westernplows.com for accessory compatibility and availability.

MOLDBOARD AVAILABILITY

Powder Coated Steel: 6' widths – straight and v-plow

WHEN ONLY A SKID-STEER WILL DO.

The WESTERN® skid-steer snowplow lineup makes busting out parking lots quicker and easier than ever before. Choose the easy-to-use and ultra-efficient PRODIGY™ snowplow or the heavy-duty and always reliable PRO PLUS® snowplows, so your crew can get the job done quicker and move on to the next lot faster.

PRODIGY SKID-STEER PLOW

The PRODIGY snowplow features patented wing technology that automatically adjusts to the most efficient plowing configuration for the job. The automatic movement of the wings is ideal for skid-steers because it provides wing-plow performance on a skid-steer platform with no additional wiring or controls.

PRO PLUS SKID-STEER PLOW

The impressive strength of the PRO PLUS snowplow makes it the straight blade of choice for punishing skid-steer applications. The PRO PLUS plow comes in a variety of blade widths so you can find the perfect plow for the job.

ONBOARD HYDRAULICS

Skid-steer plows are quick to install and easy to operate. Leverage the skid-steer's onboard hydraulic system for powerful, efficient operation. Relief valves help protect the operator and the equipment when encountering hidden obstacles.

OSCILLATING SKID-STEER MOUNT

The universal, oscillating, skid-steer mounting plate provides a number of application options. With six degrees of total side-to-side oscillation, the blade can easily follow the contours of the pavement for a cleaner scrape.



ACCESSORIES

Rubber Deflectors | Shoe Kits
Hydraulic Coupler Kit

Consult your local WESTERN dealer or westernplows.com for accessory compatibility and availability.

PILE DRIVER™ STEEL EDGE

PUSH PRODUCTIVITY FURTHER.

Push the productivity of your snow removal operations further by using the full force of your compact equipment. With the WESTERN® PILE DRIVER™ steel edge pusher plows, operators can push and stack snow confidently with the robust, steel trip-edge design. The pushers quickly and easily attach to skid-steers, backhoes, wheel loaders and tractors requiring only the use of bolt-on, interchangeable attachment plates and are available in multiple sizes.

PLOW BLADE CONSTRUCTION

The 8' and 10' PILE DRIVER steel edge pusher plows come equipped with an enhanced, heavy-duty blade design. The pusher plows feature a 10-gauge moldboard for superior strength and an aggressive 63-degree attack angle to help scrape hard-packed snow and ice. Measuring 32 ½" tall, the pusher plows are finished with a high-gloss, industrial paint that is salt- and UV-resistant to protect against corrosion.

STRUCTURAL SUPPORT

For heavy-duty performance on large accounts, these pusher plows feature six vertical support ribs for structural integrity, which prevents twisting and maximizes bucket impact strength. The robust side support posts help provide protection for the wings against bending from hitting curbs or other accidental impact.

STEEL TRIP-EDGE

The steel trip-edge design provides a cleaner scrape for hard-packed snow and ice, while protecting you and your equipment when encountering hidden bumps or obstacles.

The steel trip-edge is constructed with four extension springs and reinforced with two double ribs at the trip springs to handle large snow loads and stresses. The steel cutting edge is center punched, which results in an improved service life.

INTERCHANGEABLE ATTACHMENT PLATES

Interchangeable, bolt-on attachment plates offer the flexibility to quickly and easily attach the pushers to various types of equipment within a fleet, including skid-steers, tractors, backhoes and wheel loaders.

ACCESSORIES

Back Drag Edge | High Wear Shoe Kit | Chain Kit

Consult your local WESTERN dealer or westernplows.com for accessory compatibility and availability.



SKID-STEER ATTACHMENT PLATES



TRACTOR ATTACHMENT PLATES



WHEEL LOADER/BACKHOE ATTACHMENT PLATES

PILE DRIVER™ RUBBER EDGE

WHEN THE JOB DEMANDS THE BIGGEST PLOW.

There's no way around it: Big lots demand big equipment. The WESTERN® PILE DRIVER™ rubber edge pusher plows attach quickly and easily to backhoes and wheel loaders, giving you the power to clean up the biggest jobs in minimal time. And they are designed with a professional-duty, premium rubber cutting edge for unmatched durability on any road surface.

PLOW BLADE CONSTRUCTION

The PILE DRIVER rubber edge pusher plows are built for long life and trouble-free performance. Available in 12' for backhoes and 12', 14' and 16' for wheel loaders.

STRUCTURAL SUPPORT

A structural steel channel across the entire blade is internally lined with stiffener ribs for structural integrity and bucket-impact strength. Side-support posts provide protection against bending from curbs or other accidental impact.



PILE DRIVER FOR BACKHOES

Available in a 12' width, the PILE DRIVER rubber edge pusher plow for backhoes moves up to 11 cubic yards of snow.

QUICK-CHANGE ATTACHMENT SYSTEM

Fully formed gussets support both the upper and lower posts, which connect directly with the internal stiffener ribs for strength and support.

STANDARD CUTTING EDGE AND SHOES

The premium rubber cutting edge is adjustable and reversible to maximize use. Abrasion-resistant, steel wear shoes on the sideplates enhance the life of the cutting edge.



PILE DRIVER FOR WHEEL LOADERS

Available in 12', 14' and 16' widths, the PILE DRIVER rubber edge pusher plow for wheel loaders moves up to 15, 18 and 21 cubic yards of snow.

RB-400 ROTARY BROOM

SWEEP IT CLEAN.

Wrap up detailing jobs in one clean sweep. The WESTERN® RB-400 walk-behind rotary broom is a combination sweeper/snowplow that sweeps and scrapes the sidewalk clean along buildings, curbs and edging.



STANDARD FEATURES

- Adjustable broom-rotation speed and adjustable down-pressure allow you to adapt to any condition.
- The floating, pivoting broom head gives you five angle settings to adjust the trajectory of the snow.
- Quick-attach plow blade features wheels and floating design to move heavy or deep snow.
- Features a seven-position handlebar height adjustment for operator comfort.
- Active-assist steering and freewheel design allow for 360-degree turning.
- The three-speed gear box provides the ideal operating speed, and the powered reverse function improves maneuverability and reduces operator fatigue.
- The unique brush-head design features angled outer bristles to clean up-close to buildings, curbs and edging.

ACCESSORIES

Debris Collector | Multi-Purpose Bristles

Consult your local WESTERN dealer or westernplows.com for accessory compatibility and availability.



“

PUSHER SHOVELS

PUSH MORE PROFITS.

Available in blade widths of 30" and 36", new WESTERN Heavy-Duty Pusher shovels are constructed with wear-resistant polyethylene and reinforced at the bracket and handle to withstand the demands of commercial fleets.



STANDARD FEATURES

- The blade is constructed from ultra-high molecular weight polyethylene for superior strength and wear resistance.
- The D-shaped nylon handle improves operator grip when shoveling, season after season.
- A fiberglass pole is securely fastened to the blade with a reinforced triangular base and heavy-duty support bracket for added strength against heavy snow.

PROTECT YOUR INVESTMENT WITH WESTERN® PARTS & ACCESSORIES.



Ensure your WESTERN® snow removal equipment remains efficient and reliable season after season with Factory Original parts and accessories from your local WESTERN dealer. Using “will-fit” alternatives can alter your plow’s performance and may affect your product warranty. Stick with the WESTERN brand for the parts and accessories you need. It’s the smart choice for protecting your investment.



CUTTING EDGES

Keep your blade at the top of its game by installing a genuine WESTERN cutting edge. Cutting edges increase wear resistance and restore your worn base angle to the proper geometry. Steel, rubber, poly and carbide options available depending on plow model.



RUBBER SNOW DEFLECTORS – 10" AND 18"

Made from 2-ply, heavy-duty rubber, these easy-to-install rubber deflector kits provide improved visibility by deflecting snow forward instead of onto your windshield.



POLY SNOW DEFLECTOR

This heavy-duty poly snow deflector is curved to improve snow containment and Roll-Action™ handling.

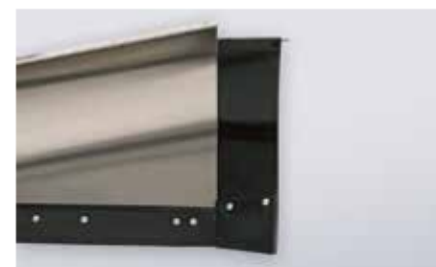

PLOW WINGS

Expand the carrying capacity of your MVP 3™, MVP PLUS™, PRO PLUS® and IMPACT™ UTV v-plow by adding a pair of genuine WESTERN plow wings. MVP 3 plow wings shown.



CURB GUARDS

Constructed of abrasion-resistant material and designed to fit tight to the blade, curb guards allow you to plow along curbs without damaging your blade. Curb guards vary by plow model.



SHOE KITS

Shoe kits help your plow glide over gravel and dirt at the correct height and extend cutting edge and base angle life when plowing on rocky or abrasive surfaces. Kits vary by plow model. High wear shoe kits available for specific models.

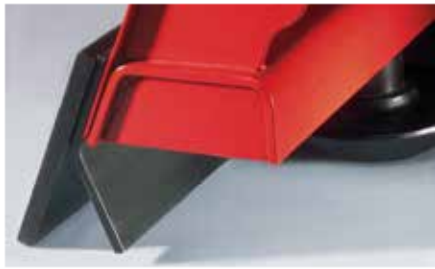

BACK DRAG EDGE

Angled to maximize back dragging, the WESTERN® back drag edge is constructed of ¼" abrasion-resistant steel. Easy to install, a back drag edge ensures a clean scrape every time.



BLADE STOPS

Protect your plow by ensuring heavy loads are distributed evenly. Made of reinforced, ¾", high-strength steel tube, blade stops reduce stress and wear on heavy-duty plow blades.



LIGHT BAR KIT

The IMPACT™ UTV light bar accessory features twin LED headlamps to help keep you on the right path. Like IMPACT UTV snowplows, the light bar accessory is sturdy and engineered to stand up to the rigors of commercial plowing operations.



SNOWPLOW EMERGENCY PARTS KIT

Be prepared! Packed in an easy-to-store WESTERN® Factory Original nylon duffel bag, these parts kits provide the high-volume, Factory Original parts needed for emergency snowplow repairs.



HIGH-PERFORMANCE HYDRAULIC FLUID

Available in quart and gallon containers, WESTERN high-performance hydraulic fluid is formulated to provide better viscosity in all temperatures. This means your plow will operate at the optimum level no matter what the weather conditions.



WESTERN FACTORY ORIGINAL PAINT

Time to touch up your WESTERN snowplow blade or black iron? Available in spray or quart cans, in red or black, topcoat or the primer-based undercoat, these Factory Original paints provide durable coverage and are formulated to match your original equipment.



WESTERN BLADE GUIDES WITH FLAGS

These attractive blade guides with replaceable flags help improve operator visibility and plow blade positioning.



COMMERCIAL BLADE GUIDES

Commercial blade guides are highly visible bright red, enhanced with reflective tape, and available in 24" or 36" lengths.



SHOCK ABSORBER

Helps soften trip-blade return. Available for the PRODIGY™, WIDE-OUT™ and WIDE-OUT™ XL snowplows.



MULTIPURPOSE BRISTLES

The multipurpose bristle kit replaces the snow brushes on the RB-400 rotary broom during the off-season. This allows you to use the machine for sweeping debris on a wide variety of surfaces and applications.



DEBRIS COLLECTOR

The debris collector gives you full use of your RB-400 rotary broom year round. It easily attaches to the front of the machine, so you can sweep up waste and debris quickly, keep it contained and dispose of it properly.



EXTREME DEFENSE™ GREASE

Defends and protects plow and spreader bearings, pivot points and moving components from wear and corrosion, even in extreme cold.



SNOWPLOW CONTROL CUP HOLDER MOUNT

Put a hard stop to juggling snowplow controls and cell phones. Functional and practical, the snowplow control cup holder mount lets you secure your WESTERN plow controls or your smartphone* on a flexible gooseneck mount for optimal, customizable positioning. This compact, easy-to-install genuine WESTERN accessory is designed to fit firmly into most cup holders in your vehicle.



FLEX ARM™ QUICK-RELEASE FLEXIBLE CONTROL MOUNT

The quick-release, flexible control mount adjusts to any position and features a magnetic base for easy removal without needing to put mounting holes in your dash.



PRO-GRIP MOUNT

Kit contains adhesive-backed locking strips to secure the WESTERN solenoid control and spreader controls to interior vehicle surfaces. Allows the control to be easily removed yet held firmly in place.



CONVERSION KIT

This easy-to-use UltraMount® to UniMount® conversion kit enables you to attach a UniMount plow to a vehicle equipped with an UltraMount system vehicle mount. This kit is perfect if you have multiple snowplows.



BACK DRAG EDGE

Available for the PILE DRIVER™ steel edge pusher plow, the top-mounted, rubber back drag edge allows operators to pull snow away from loading docks, doors and other tight spaces.



HIGH WEAR SHOES

Available for the PILE DRIVER steel edge pusher plow, high wear shoes provide increased service life for extreme-use applications.

SPECIFICATIONS

MVP 3™



| PLOW TYPE | V-PLOW | V-PLOW | V-PLOW | V-PLOW |
|-------------------------------------|-----------------------------------------------------------------------------|----------------------------------------------------------------------------|----------------------------------------------------------------------------|-----------------------------------------------------------------------------|
| MOLDBOARD OPTIONS | Steel/Stainless | Steel/Stainless/Poly | Steel/Stainless/Poly | Steel/Stainless |
| BLADE WIDTH | 7'6" (2.29 m) | 8'6" (2.59 m) | 9'6" (2.90 m) | 10'6" (3.20 m) |
| BLADE HEIGHT | At Center: 31" (78.74 cm) At End: 37" (93.98 cm) | At Center: 31" (78.74 cm) At End: 38" (96.52 cm) | At Center: 31" (78.74 cm) At End: 39" (99.06 cm) | At Center: 35" (88.90 cm) At End: 45" (114.30 cm) |
| BLADE THICKNESS | 14 ga (1.98 mm) | 14 ga (1.98 mm) Poly: ¼" (6.40 mm) | 14 ga (1.98 mm) Poly: ¼" (6.40 mm) | Steel: 11 ga (3.05 mm) Stainless: 12 ga (2.66 mm) |
| SHOCK ABSORBERS | — | — | — | — |
| TRIP SPRINGS | 4 | 4 | 6 | 6 |
| RIBS | 6 | 8 | 8 | 8 |
| LIFT CYLINDER | 1 ¾" x 8" (4.45 cm x 20.32 cm) | 1 ¾" x 8" (4.45 cm x 20.32 cm) | 1 ¾" x 8" (4.45 cm x 20.32 cm) | 1 ¾" x 8" (4.45 cm x 20.32 cm) |
| ANGLING RAMS | 1 ¾" x 11" (4.45 cm x 27.94 cm) | 1 ¾" x 11" (4.45 cm x 27.94 cm) | 1 ¾" x 11" (4.45 cm x 27.94 cm) | 2" x 11" (5.08 cm x 27.94 cm) |
| PLOWING WIDTH (FULL ANGLE) | Full Angle: 6'7" (2.01 m) Scoop: 6'4" (1.93 m) Full V: 6'10" (2.08 m) | Full Angle: 7'5" (2.26 m) Scoop: 7'2" (2.18 m) Full V: 7'8" (2.34 m) | Full Angle: 8'6" (2.59 m) Scoop: 8'2" (2.49 m) Full V: 8'7" (2.62 m) | Full Angle: 9'9" (2.97 m) Scoop: 9'7" (2.92 m) Full V: 9'11" (3.02 m) |
| APPROX. WEIGHT* (LESS MOUNT) | 885 lb (401.43 kg) | 940 lb (426.38 kg) Poly: 890 lb (403.70 kg) | 1022 lb (463.57 kg) Poly: 972 lb (440.89 kg) | 1196 lb (542.50 kg) |
| CUTTING EDGE | ¾" x 6" (0.95 cm x 15.24 cm) ½" x 6*** (1.27 cm x 15.24 cm) | ¾" x 6" (0.95 cm x 15.24 cm) ½" x 6*** (1.27 cm x 15.24 cm) | ½" x 6" (1.27 cm x 15.24 cm) | ½" x 6" (1.27 cm x 15.24 cm) |
| MOUNT TYPE | UltraMount® 2 | UltraMount 2 | UltraMount 2 | UltraMount 2 |

* UltraMount 2 mount weight range: 28 to 145 lb (12.70 to 65.77 kg)

** Optional accessory

MVP PLUS™



| PLOW TYPE | V-PLOW | V-PLOW | V-PLOW |
|-------------------------------------|----------------------------------------------------------------------------|----------------------------------------------------------------------------|-----------------------------------------------------------------------------|
| MOLDBOARD OPTIONS | Steel/Poly | Steel/Poly | Steel/Poly |
| BLADE WIDTH | 7'6" (2.29 m) | 8'6" (2.59 m) | 9'6" (2.90 m) |
| BLADE HEIGHT | 29" (73.66 cm) | 29" (73.66 cm) | 31" (78.74 cm) |
| BLADE THICKNESS | Steel: 14 ga (1.98 mm) Poly: ¼" (6.40 mm) | Steel: 14 ga (1.98 mm) Poly: ¼" (6.40 mm) | Steel: 14 ga (1.98 mm) Poly: ¼" (6.40 mm) |
| SHOCK ABSORBERS | — | — | — |
| TRIP SPRINGS | 4 | 4 | 6 |
| RIBS | 6 | 8 | 8 |
| LIFT CYLINDER | 1 ½" x 8" (3.81 cm x 20.32 cm) | 1 ½" x 8" (3.81 cm x 20.32 cm) | 1 ½" x 8" (3.81 cm x 20.32 cm) |
| ANGLING RAMS | 1 ¾" x 11" (4.45 cm x 27.94 cm) | 1 ¾" x 11" (4.45 cm x 27.94 cm) | 1 ¾" x 11" (4.45 cm x 27.94 cm) |
| PLOWING WIDTH (FULL ANGLE) | Full Angle: 6'6" (1.98 m) Scoop: 6'3" (1.91 m) Full V: 6'9" (2.06 m) | Full Angle: 7'5" (2.26 m) Scoop: 7'1" (2.16 m) Full V: 7'7" (2.31 m) | Full Angle: 8'3" (2.51 m) Scoop: 7'11" (2.41 m) Full V: 8'7" (2.62 m) |
| APPROX. WEIGHT* (LESS MOUNT) | Steel: 827 lb (375.12 kg) Poly: 799 lb (362.42 kg) | Steel: 880 lb (399.16 kg) Poly: 847 lb (384.19 kg) | Steel: 988 lb (448.15 kg) Poly: 964 lb (437.26 kg) |
| CUTTING EDGE | ¾" x 6" (0.95 cm x 15.24 cm) ½" x 6*** | ¾" x 6" (0.95 cm x 15.24 cm) ½" x 6*** | ½" x 6" (1.27 cm x 15.24 cm) |
| MOUNT TYPE | UltraMount 2 | UltraMount 2 | UltraMount 2 |

* UltraMount 2 mount weight range: 28 to 145 lb (12.70 to 65.77 kg)

** Optional accessory

WIDE-OUT™**



WIDE-OUT™ XL

PRODIGY™



| PLOW TYPE | WINGED | WINGED | WINGED |
|-------------------------------------|----------------------------------------------------------------------------|-------------------------------------------------------------------------------|-----------------------------------------------------|
| MOLDBOARD OPTIONS | Steel | Steel | Steel |
| BLADE WIDTH | Retracted: 8' (2.44 m) Expanded: 10' (3.05 m) Scoop: 8'10" (2.69 m) | Retracted: 8'6" (2.59 m) Expanded: 11' (3.35 m) Scoop: 9'10" (3.00 m) | Scoop: 8'7" (2.62 m) Wings Pinned: 9'8" (2.95 m) |
| BLADE HEIGHT | At Center: 31" (78.74 cm) At End: 35" (88.90 cm) | At Center: 31" (78.74 cm) At End: 36" (91.44 cm) | 29 ½" (74.93 cm) |
| BLADE THICKNESS | 14 ga (2.11 mm) | 14 ga (2.11 mm) | 12 ga (2.78 mm) |
| SHOCK ABSORBERS | Optional | Optional | Optional |
| TRIP SPRINGS | 4 | 4 | 4 |
| RIBS | 6 | 8 | 8 |
| LIFT CYLINDER | 1 ¾" x 8" (4.45 cm x 20.32 cm) | 1 ¾" x 8" (4.45 cm x 20.32 cm) | 1 ½" x 8" (3.81 cm x 20.32 cm) |
| ANGLING RAMS | 1 ½" x 10" (3.81 cm x 25.40 cm) | 1 ½" x 10" (3.81 cm x 25.40 cm) | 1 ½" x 10" (3.81 cm x 25.40 cm) |
| PLOWING WIDTH (FULL ANGLE) | Retracted: 7'2" (2.18 m) Expanded: 9' (2.74 m) Scoop: 7'11" (2.41 m) | Retracted: 7'11" (2.41 m) Expanded: 10'6" (3.20 m) Scoop: 9'6" (2.90 m) | Full Angle: 7'10" (2.39 m) Scoop: 8'7" (2.61 m) |
| APPROX. WEIGHT* (LESS MOUNT) | 1020 lb (462.66 kg) | 1090 lb (494.42 kg) | 880 lb (399.16 kg) |
| CUTTING EDGE | ½" x 6" (1.27 cm x 15.24 cm) | ½" x 6" (1.27 cm x 15.24 cm) | ½" x 6" (1.27 cm x 15.24 cm) |
| MOUNT TYPE | UltraMount® 2 | UltraMount 2 | UltraMount 2 |

* UltraMount 2 mount weight range: 28 to 145 lb (12.70 to 65.77 kg)

** All product features and specifications listed in this brochure apply to WIDE-OUT snowplows with serial numbers beginning with 180210 and higher

PRO PLUS® HD

PRO PLUS®



| PLOW TYPE | STRAIGHT | STRAIGHT | STRAIGHT | STRAIGHT |
|-------------------------------------|---------------------------------|---------------------------------|---------------------------------|---------------------------------|
| MOLDBOARD OPTIONS | Steel | Steel | Steel | Steel |
| BLADE WIDTH | 10' (3.05 m) | 8' (2.44 m) | 8'6" (2.59 m) | 9' (2.74 m) |
| BLADE HEIGHT | 34" (86.36 cm) | 31 ½" (80.01 cm) | 31 ½" (80.01 cm) | 31 ½" (80.01 cm) |
| BLADE THICKNESS | 11 ga (3.05 mm) | 12 ga (2.78 mm) | 12 ga (2.78 mm) | 12 ga (2.78 mm) |
| SHOCK ABSORBERS | 2 | 2 | 2 | 2 |
| TRIP SPRINGS | 6 | 4 | 4 | 4 |
| RIBS | 8 | 8 | 8 | 8 |
| LIFT CYLINDER | 1 ¾" x 8" (4.45 cm x 20.32 cm) | 1 ½" x 8" (3.81 cm x 20.32 cm) | 1 ½" x 8" (3.81 cm x 20.32 cm) | 1 ½" x 8" (3.81 cm x 20.32 cm) |
| ANGLING RAMS | 2" x 12 ½" (5.08 cm x 31.75 cm) | 1 ½" x 12" (3.81 cm x 30.48 cm) | 1 ½" x 12" (3.81 cm x 30.48 cm) | 1 ½" x 12" (3.81 cm x 30.48 cm) |
| PLOWING WIDTH (FULL ANGLE) | 8'9" (2.67 m) | 6'11" (2.11 m) | 7'4" (2.24 m) | 7'9" (2.36 m) |
| APPROX. WEIGHT* (LESS MOUNT) | 1075 lb (487.61 kg) | 805 lb (365.14 kg) | 821 lb (372.40 kg) | 837 lb (379.66 kg) |
| CUTTING EDGE | ½" x 6" (1.27 cm x 15.24 cm) | ½" x 6" (1.27 cm x 15.24 cm) | ½" x 6" (1.27 cm x 15.24 cm) | ½" x 6" (1.27 cm x 15.24 cm) |
| MOUNT TYPE | UltraMount 2 | UltraMount 2 | UltraMount 2 | UltraMount 2 |

* UltraMount 2 mount weight range: 28 to 145 lb (12.70 to 65.77 kg)

SPECIFICATIONS CONT.

PRO-PLOW® SERIES 2

| PLOW TYPE | STRAIGHT | STRAIGHT | STRAIGHT |
|-------------------------------------|-------------------------------------------------------|-------------------------------------------------------|-----------------------------------|
| MOLDBOARD OPTIONS | Steel/Poly | Steel/Poly | Steel |
| BLADE WIDTH | 7'6" (2.29 m) | 8' (2.44 m) | 8'6" (2.59 m) |
| BLADE HEIGHT | 29" (73.66 cm) | 29" (73.66 cm) | 29" (73.66 cm) |
| BLADE THICKNESS | Steel: 11 ga (3.18 mm) Poly: 3/8" (9.52 mm) | Steel: 11 ga (3.18 mm) Poly: 3/8" (9.52 mm) | 11 ga (3.18 mm) |
| SHOCK ABSORBERS | 1 | 1 | 1 |
| TRIP SPRINGS | 4 | 4 | 4 |
| RIBS | 7 | 7 | 7 |
| LIFT CYLINDER | 1 1/2" x 8" (3.81 cm x 20.32 cm) | 1 1/2" x 8" (3.81 cm x 20.32 cm) | 1 1/2" x 8" (3.81 cm x 20.32 cm) |
| ANGLING RAMS | 1 1/2" x 10" (3.81 cm x 25.40 cm) | 1 1/2" x 10" (3.81 cm x 25.40 cm) | 1 1/2" x 10" (3.81 cm x 25.40 cm) |
| PLOWING WIDTH (FULL ANGLE) | 6'6" (1.98 m) | 6'11" (2.11 m) | 7'4" (2.24 m) |
| APPROX. WEIGHT* (LESS MOUNT) | Steel: 653 lb (296.20 kg) Poly: 677 lb (307.08 kg) | Steel: 668 lb (303.00 kg) Poly: 690 lb (313.00 kg) | 686 lb (311.16 kg) |
| CUTTING EDGE | 3/8" x 6" (0.95 cm x 15.24 cm) | 3/8" x 6" (0.95 cm x 15.24 cm) | 3/8" x 6" (0.95 cm x 15.24 cm) |
| MOUNT TYPE | UltraMount® 2 | UltraMount 2 | UltraMount 2 |

* UltraMount 2 mount weight range: 28 to 145 lb (12.70 to 65.77 kg)

MIDWEIGHT™

| PLOW TYPE | STRAIGHT | STRAIGHT |
|-------------------------------------|-------------------------------------------------------|----------------------------------|
| MOLDBOARD OPTIONS | Steel/Poly | Steel |
| BLADE WIDTH | 7'6" (2.29 m) | 7'6" (2.29 m) |
| BLADE HEIGHT | 27" (68.58 cm) | 27" (68.58 cm) |
| BLADE THICKNESS | Steel: 14 ga (1.98 mm) Poly: 1/4" (6.40 mm) | 14 ga (1.98 mm) |
| TRIP SPRINGS | 2 | 2 |
| SHOCK ABSORBERS | — | — |
| RIBS | 6 | 6 |
| LIFT CYLINDER | 1 1/2" x 8" (3.81 cm x 20.32 cm) | 2" x 6 3/4" (5.08 cm x 17.15 cm) |
| ANGLING RAMS | 1 1/2" x 10" (3.81 cm x 25.40 cm) | 1 1/2" x 8" (3.81 cm x 20.32 cm) |
| PLOWING WIDTH (FULL ANGLE) | 6'6" (1.98 m) | 6'7" (2.01 m) |
| APPROX. WEIGHT* (LESS MOUNT) | Steel: 540 lb (244.94 kg) Poly: 532 lb (241.31 kg) | 412 lb (186.90 kg) |
| CUTTING EDGE | 3/8" x 6" (0.95 cm x 15.24 cm) | 3/8" x 6" (0.80 cm x 15.24 cm) |
| MOUNT TYPE | UltraMount 2 | UltraMount® |

* UltraMount 2 mount weight range: 28 to 145 lb (12.70 to 65.77 kg)

HTS™



DEFENDER™

| PLOW TYPE | STRAIGHT | STRAIGHT |
|------------------------------------|--------------------------------|--------------------------------|
| MOLDBOARD OPTIONS | Steel | Steel |
| BLADE WIDTH | 6'8" (2.00 m) | 7'2" (2.10 m) |
| BLADE HEIGHT | 23 1/2" (59.70 cm) | 23 1/2" (59.70 cm) |
| BLADE THICKNESS | 16 ga (1.50 mm) | 16 ga (1.50 mm) |
| SHOCK ABSORBERS | — | — |
| TRIP SPRINGS | 2 | 2 |
| RIBS | 6 | 6 |
| PLOWING WIDTH (FULL ANGLE) | 5'11" (1.80 m) | 6'4 1/2" (1.90 m) |
| APPROX. WEIGHT (LESS MOUNT) | 290 lb (131.54 kg) | 297 lb (134.72 kg) |
| CUTTING EDGE | 1/4" x 5" (0.60 cm x 12.70 cm) | 1/4" x 5" (0.60 cm x 12.70 cm) |

IMPACT™

| PLOW TYPE | UTV – V-PLOW | UTV – STRAIGHT |
|-------------------------------------|------------------------------------------------------------------------|----------------------------------|
| MOLDBOARD OPTIONS | Steel | Steel |
| BLADE WIDTH | 6' (1.83 m) | 6' (1.83 m) |
| BLADE HEIGHT | At Center: 25 3/4" (65.40 cm) At End: 29 1/4" (74.29 cm) | 23 1/2" (59.70 cm) |
| BLADE THICKNESS | 14 ga (1.90 mm) | 14 ga (1.90 mm) |
| SHOCK ABSORBERS | — | — |
| TRIP SPRINGS | 2 | 2 |
| RIBS | 6 | 4 |
| LIFT CYLINDER | 1 1/2" x 6" (3.81 cm x 15.24 cm) | 1 1/2" x 6" (3.81 cm x 15.24 cm) |
| ANGLING RAMS | 1" x 8 3/4" (2.54 cm x 22.23 cm) | 1" x 7" (2.5 cm x 18 cm) |
| PLOWING WIDTH** (FULL ANGLE) | Full Angle: 5' (1.52 m) Scoop: 4'7" (1.39 m) Full V: 5' (1.52 m) | 5'4" (1.60 m) |
| APPROX. WEIGHT* | 354 lb (160.57 kg) | 261 lb (118.39 kg) |
| CUTTING EDGE | 1/4" x 5" (0.64 cm x 12.70 cm) | 1/4" x 5" (0.64 cm x 12.70 cm) |
| MOUNT TYPE | UTV Mounting System | UTV Mounting System |

* Plus vehicle mount

**IMPACT UTV V-Plow: For UTVs with a wider wheelbase, width can be adjusted to: 5' 6" (1.68 m) full angle, 5' 1" (1.55 m) scoop, 5' 6" (1.68 m) full V

SPECIFICATIONS CONT.



PRODIGY™

PRO PLUS®

| PLOW TYPE | SKID-STEER | SKID-STEER | SKID-STEER | SKID-STEER |
|-----------------------------------|-----------------------------------------------------|--------------------------------------|--------------------------------------|--------------------------------------|
| MOLDBOARD OPTIONS | Steel | Steel | Steel | Steel |
| BLADE WIDTH | Scoop: 8'7" (2.62 m) Wings Pinned: 9'8" (2.95 m) | 8' (2.44 m) | 8'6" (2.59 m) | 9' (2.74 m) |
| BLADE HEIGHT | 29 1/2" (74.93 cm) | 31 1/2" (80.01 cm) | 31 1/2" (80.01 cm) | 31 1/2" (80.01 cm) |
| BLADE THICKNESS | 12 ga (2.78 mm) | 12 ga (2.78 mm) | 12 ga (2.78 mm) | 12 ga (2.78 mm) |
| SHOCK ABSORBERS | Optional | 2 | 2 | 2 |
| TRIP SPRINGS | 4 | 4 | 4 | 4 |
| RIBS | 8 | 8 | 8 | 8 |
| ANGLING RAMS | 1 1/2" x 10" (3.81 cm x 25.40 cm) | 1 1/2" x 12" (3.81 cm x 30.48 cm) | 1 1/2" x 12" (3.81 cm x 30.48 cm) | 1 1/2" x 12" (3.81 cm x 30.48 cm) |
| PLOWING WIDTH (FULL ANGLE) | 7'10" (2.39 m) | 6'11" (2.11 m) | 7'4" (2.24 m) | 7'9" (2.36 m) |
| CUTTING EDGE | 1/2" x 6" (1.27 cm x 15.24 cm) | 1/2" x 6" (1.27 cm x 15.24 cm) | 1/2" x 6" (1.27 cm x 15.24 cm) | 1/2" x 6" (1.27 cm x 15.24 cm) |
| MOUNT TYPE | Universal Skid-Steer Mount | Universal Skid-Steer Mount | Universal Skid-Steer Mount | Universal Skid-Steer Mount |



PILE DRIVER™

| PLOW TYPE | UNIVERSAL | UNIVERSAL | BACKHOE | WHEEL LOADER | WHEEL LOADER | WHEEL LOADER |
|------------------------------------------------------|--------------------------------------------|--------------------------------------------|--------------------------------|--------------------------------|--------------------------------|--------------------------------|
| CUTTING EDGE | Steel | Steel | Rubber | Rubber | Rubber | Rubber |
| MOLDBOARD OPTIONS | Steel | Steel | Steel | Steel | Steel | Steel |
| BLADE WIDTH | 8' (2.44 m) | 10' (3.05 m) | 12' (3.66 m) | 12' (3.66 m) | 14' (4.27 m) | 16' (4.88 m) |
| BLADE HEIGHT | 32 1/2" (0.83 m) | 32 1/2" (0.83 m) | 36" (0.91 m) | 48" (1.21 m) | 48" (1.21 m) | 48" (1.21 m) |
| APPROX. WEIGHT | 1012 lb (459.04 kg) | 1140 lb (517.10 kg) | 1150 lb (521.63 kg) | 1680 lb (762.04 kg) | 1815 lb (823.27 kg) | 1950 lb (884.51 kg) |
| MACHINE APPLICATION | Skid-Steer, Wheel Loader, Backhoe, Tractor | Skid-Steer, Wheel Loader, Backhoe, Tractor | 4WD | 1.5 yd (1.37 m) | 2 yd (1.82 m) | 3 yd (2.74 m) |
| SNOW CAPACITY | 6.4 cu yd (4.89 cu m) | 8 cu yd (6.12 cu m) | 11 cu yd (10.06 cu m) | 15 cu yd (13.72 cu m) | 18 cu yd (16.46 cu m) | 21 cu yd (19.20 cu m) |
| MOUNT TYPE | Interchangeable Attachment Plates | Interchangeable Attachment Plates | Quick-Change Attachment System | Quick-Change Attachment System | Quick-Change Attachment System | Quick-Change Attachment System |
| SKID-STEER HORSEPOWER COMPATIBILITY | 45+ hp | 60+ hp | | | | |
| WHEEL LOADER/BACKHOE HORSEPOWER COMPATIBILITY | 60+ hp | 60+ hp | | | | |
| TRACTOR HORSEPOWER COMPATIBILITY | 40+ hp | 50+ hp | | | | |

Specifications subject to change without prior notice. Please visit westernplows.com for the most current specifications.

RB-400



| PLOW TYPE | WALK-BEHIND ROTARY BROOM |
|---------------------------------------|-----------------------------------------------------------------------------------------------------------------------------------------------------|
| EMPTY WEIGHT | 238 lb (108.00 kg) |
| OVERALL DIMENSIONS (L x W x H) | Without Blade: 72" x 40" x 42 1/2" (183.00 cm x 102.00 cm x 108.00 cm) With Blade: 80" x 40" x 42 1/2" (203.00 cm x 102.00 cm x 108.00 cm) |
| SPEED | Up to 2.7 mph (4.40 km/h) |
| FORWARD GEARS | 3 |
| REVERSE GEARS | 1 |
| BRUSH PRESSURE ADJUSTMENT | Yes |
| ADJUSTABLE HANDLE HEIGHT | 7 Positions |
| ENGINE | Honda® GXV 160 OHV |
| TIRES | Polar Trec Snow Tires |
| SNOW BLADE WIDTH | Wide: 40" (102.00 cm) Angled: 37" (94.00 cm) |
| BRUSH DIAMETER | 16" (40.60 cm) |
| BRUSH WIDTH | 40" (102.00 cm) |
| FUEL CAPACITY | 0.5 gal (1.9 L) |

PUSHER SHOVEL



| PLOW TYPE | WALK-BEHIND SHOVEL | |
|---------------------------|---------------------------------------------------------|---------------------------------------|
| MODELS | 30" | 36" |
| BLADE DIMENSIONS | 30" x 9 1/4" (76.20 cm x 23.50 cm) | 36" x 9 1/4" (91.44 cm x 23.50 cm) |
| OVERALL DIMENSIONS | 30" x 54" (76.20 cm x 137.20 cm) | 36" x 54" (91.44 cm x 137.20 cm) |
| WEIGHT | 6 lb (2.72 kg) | 7 lb (3.18 kg) |
| MATERIAL | Blade: UHMW-PE Pole: Fiberglass | Blade: UHMW-PE Pole: Fiberglass |
| HANDLE | Nylon reinforced D-shape | Nylon reinforced D-shape |
| COLOR | Blade and Handle: Black Pole: Red | Blade and Handle: Black Pole: Red |
| APPLICATIONS | Commercial & Industrial locations, sidewalks, entryways | |
| LEVEL OF SNOW | Best in up to 4"-5" (10.16 cm-12.70 cm) of snow | |



“

GIVE EVERY JOB THE **FINISHING TOUCH.**

Ice? Sleet? Make sure you've got it all covered with WESTERN® ice control products, built to keep salt, sand and brine delivery consistent, efficient and completely under your control.

To view our full line of WESTERN spreaders, check out our spreader brochure or visit westernplows.com.



ENFORCER™ V-PLOW

PUT YOUR HALF-TON TRUCK TO WORK

The all-new WESTERN® ENFORCER™ v-plow, with trip-edge design, is constructed of high-strength, low alloy steel that makes it stronger and lighter than conventional steel, and the ideal weight for half-ton trucks. The ENFORCER v-plow is engineered with the features and benefits of full-size WESTERN v-plows, brought down into a lightweight design for today's homeowners and contractors.



MORE JOBS. **DONE FASTER.**

ENFORCER™ V-PLOW



PURPOSE-BUILT FOR HALF-TON TRUCKS

BLADE OPTIONS & CONSTRUCTION

Available in either stainless steel or powder-coated steel, the ENFORCER™ v-plow features a blade width of 7'6" and flared wings with a height of 27" at the center up to 33" at the outer edges. Constructed of high-strength, low alloy steel, the ENFORCER v-plow is stronger and lighter than conventional steel, and the ideal weight for half-ton trucks.

ULTRALOCK DOUBLE-ACTING CYLINDERS

Like larger WESTERN® v-plow models, the ENFORCER v-plow comes standard with UltraLock double-acting cylinders that hold the wings firmly in place for clean, efficient back dragging and allow operators to control the v-plow in straight blade mode by locking the wings together.

TRIP-EDGE DESIGN

Independent trip-edge protection in all configurations—V, scoop or straight—keeps snow in front of the blade while protecting you and your equipment when encountering hidden obstacles.

EASY ATTACHMENT & CONFIGURATION

The ENFORCER v-plow easily attaches to your vehicle with the WESTERN UltraMount® 2 mounting system. Plus, it's engineered to configure to varying vehicle heights in order to maintain optimum performance.

SPECIFICATIONS

| MOLDBOARD OPTIONS | BLADE WIDTH | PLOW TYPE | BLADE HEIGHT (AT CENTER) | BLADE HEIGHT (AT END) | BLADE THICKNESS | TRIP SPRINGS | RIBS | LIFT CYLINDER | ANGLING RAMS | PLOWING WIDTH | APPROX. WEIGHT* | CUTTING EDGE | MOUNT TYPE |
|---------------------|-------------------|-----------|--------------------------|-----------------------|--------------------|--------------|----------------------------|-----------------------------------------|--------------------------------------|-------------------------------------------------------------------------------|-----------------------|-----------------------------------|---------------|
| Stainless | 7' 6" (2.29 m) | V-Plow | 27" (68.58 cm) | 33" (83.82 cm) | 14 ga (1.98 mm) | 2 | 6 Vertical 2 Horizontal | 1 1/4" x 8 3/8" (3.18 cm x 21.91 cm) | 1 1/2" x 12" (3.81 cm x 30.48 cm) | Full Angle: 6' 7" (2.01 m) Scoop: 6' 5" (1.96 m) Full V: 6' 9" (2.06 m) | 554 lb (251.29 kg) | 3/8" x 6" (0.95 cm x 15.24 cm) | UltraMount® 2 |
| Powder-Coated Steel | 7' 6" (2.29 m) | V-Plow | 27" (68.58 cm) | 33" (83.82 cm) | 14 ga (1.98 mm) | 2 | 6 Vertical | 1 1/4" x 8 3/8" (3.18 cm x 21.91 cm) | 1 1/2" x 12" (3.81 cm x 30.48 cm) | Full Angle: 6' 7" (2.01 m) Scoop: 6' 5" (1.96 m) Full V: 6' 9" (2.06 m) | 509 lb (230.88 kg) | 3/8" x 6" (0.95 cm x 15.24 cm) | UltraMount 2 |

*Weight of the vehicle mount not included.

MORE JOBS. **DONE FASTER.**

Western Products reserves the right under its product improvement policy to change construction or design details and furnish equipment when so altered without reference to illustrations or specifications used. Western Products or the vehicle manufacturer may require or recommend optional equipment for snow removal. Do not exceed vehicle ratings with a snowplow. This product is manufactured under the following patents US: 6,526,677; 6,711,837; 6,928,757; 7,400,058; 7,737,576; 9,200,418; 9,822,563; CAN patents: 2,354,257; 2,639,052; other patents pending. Western Products offers a limited warranty for all snowplows and accessories. See separately printed page for this important information. The following are registered (®) or unregistered (™) trademarks of Douglas Dynamics, LLC: EdgeView™, ENFORCER™, NIGHTHAWK™, UltraMount® 2, WESTERN®.



westernplows.com

Printed in U.S.A. | FORM NO. 79275-MR20

FEATURED ACCESSORIES

- 10" Rubber Deflector
- Shoe Kit
- AR400 Steel Curb Guards
- Cast Iron Curb Guards
- 1/2" Steel Cutting Edge
- 1" Poly Cutting Edge
- Blade Stops
- Back Drag Edge

HEADLAMP OPTIONS

Choose between LED or dual-halogen NIGHTHAWK™ headlamps. The LED headlamps feature EdgeView™ technology, providing a full 180 degrees of light from plow edge to plow edge and producing up to twice the light output of traditional halogen bulbs.

The dual-halogen headlamp option also offers improved brightness and reach with better low- and high-beam performance than traditional halogen headlamps.

2 WINTER WARRANTY

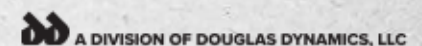

A DIVISION OF DOUGLAS DYNAMICS, LLC

Western Products | P.O. Box 245038 | Milwaukee, WI 53224-9C38

©2020 Douglas Dynamics, LLC. All rights reserved.

PILE DRIVER™

STEEL-EDGE PUSHER PLOWS (12', 14', 16')

WHEN BIG JOBS DEMAND HEAVY-DUTY PERFORMANCE

The new 12', 14' and 16' pusher plows add to the lineup of WESTERN® PILE DRIVER™ steel-edge plows. These three new sizes are designed specifically for wheel loader applications. The two-piece, steel trip-edge design delivers a cleaner scrape for hard-packed snow and ice while protecting operators and their equipment when encountering hidden bumps and obstacles.



MORE JOBS. **DONE FASTER.**

PILE DRIVER™

STEEL-EDGE PUSHER PLOWS (12', 14', 16')



**Interchangeable attachments for maximum versatility (wheel loader carrier option shown)*

DESIGNED SPECIFICALLY FOR WHEEL LOADER APPLICATIONS

TWO-PIECE, STEEL TRIP-EDGE

The two-piece, steel trip-edge design delivers a cleaner scrape for hard-packed snow and ice while protecting operators and their equipment when encountering hidden bumps and obstacles. Constructed with eight or twelve extension springs, depending on the blade width, the PILE DRIVER™ pusher plows are built to handle large snow loads and stresses.

INTERCHANGEABLE ATTACHMENTS

Interchangeable attachments offer the flexibility to quickly and easily attach the pushers to various pieces of equipment within a fleet. Attachments include a universal post option for wheel loaders and three different wheel loader carrier options along with their compatible models.



UNIVERSAL POST FOR WHEEL LOADERS

FLOATING ATTACHMENT PLATES

Floating attachment plates smooth out bumps and allow side-to-side movement, keeping the pusher in contact with the surface at all times.

FLOATING SHOES

Floating shoes keep the cutting edge level on uneven surfaces to maintain a clean scrape.

SPECIFICATIONS

| BLADE WIDTH | BLADE HEIGHT | CAPACITY | APPLICATIONS | STEEL TRIP-EDGE | APPROXIMATE WEIGHTS | MOUNT TYPE |
|-----------------|------------------------|-----------------------------|-------------------------|-----------------|---------------------------|--------------------------------|
| 12' (3.66 m) | 40 1/2" (102.87 cm) | 8 1/2 cu yd (6.50 cu m) | Wheel Loader 100+ hp | Yes | 2,128 lb (965.24 kg) | Interchangeable Attachments |
| 14' (4.27 m) | 40 1/2" (102.87 cm) | 10 cu yd (7.65 cu m) | Wheel Loader 100+ hp | Yes | 2,275 lb (1,031.92 kg) | Interchangeable Attachments |
| 16' (4.88 m) | 40 1/2" (102.87 cm) | 11 1/2 cu yd (8.79 cu m) | Wheel Loader 100+ hp | Yes | 2,512 lb (1,139.42 kg) | Interchangeable Attachments |

MORE JOBS. **DONE FASTER.**

2 WINTER WARRANTY

Western Products reserves the right under its product improvement policy to change construction or design details and furnish equipment when so altered without reference to illustrations or specifications used. Western Products or the vehicle manufacturer may require or recommend optional equipment for snow removal. Do not exceed vehicle ratings with a snowplow. Western Products offers a limited warranty for all snowplows and accessories. See separately printed page for this important information. The following are registered (®) or unregistered (™) trademarks of Douglas Dynamics, LLC: PILE DRIVER™, WESTERN™.



westernplows.com

Printed in U.S.A. | FORM NO. 79278-MR20

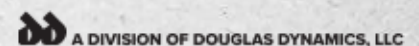

Western Products | P.O. Box 245038 | Milwaukee, WI 53224-9C38

©2020 Douglas Dynamics, LLC. All rights reserved.

ULTRAMOUNT® 2

ATTACHMENT KITS FOR TRACTORS

GET MORE PRODUCTIVITY FROM YOUR TRACTOR

The all-new WESTERN® UltraMount® 2 attachment kits for tractors accommodate the demand for non-truck mounted snowplowing applications. Designed for easy installation onto a wide range of tractor models, these kits allow you to attach WESTERN heavy-duty straight blades, v-plows and winged plows to tractors, providing increased efficiency and versatility.



MORE JOBS. **DONE FASTER.**

ULTRAMOUNT® 2

ATTACHMENT KITS FOR TRACTORS



SNOWPLOWING

VERSATILITY FOR TRACTORS

PLOW COMPATIBILITY

The UltraMount® 2 attachment kits allow for direct attachment of a range of WESTERN® heavy-duty straight blades, v-plows and winged plows to tractors for improved plowing efficiency. Check out our Quick Match program at westernplows.com/quick-match to identify which plows will fit your specific tractor model.

HEAVY-DUTY STRAIGHT BLADES FOR TRACTORS

The best value from a cost perspective when compared to other snowplow types, straight blade plows also offer operators a number of benefits. Straight blades are the easiest plows to operate with simple controls, and because there are fewer moving parts, they are extremely durable and reliable. When it comes to clearing large, open lots, straight blades are an efficient way to get the job done.

UltraMount 2 attachment kits for tractors are available for the following WESTERN straight blade models:

- PRO-PLOW® Series 2 (7'6", 8" and 8'6" models)
- PRO PLUS® (8', 8'6" and 9' models)

V-PLOWS FOR TRACTORS

Providing power, productivity and performance, v-plows are a great choice for operators that handle a variety of job types. Operate in v-mode to break through heavy snow or drifts, scoop mode when in tighter spaces or for carrying large amounts of snow, or lock the wings in straight blade mode when plowing big, wide open spaces. Bottom line, v-plows are the most universal plows to handle all plowing needs.

UltraMount 2 attachment kits for tractors are available for the following WESTERN v-plow models:

- MVP 3™ (7'6", 8'6" and 9'6" models)

WINGED PLOWS FOR TRACTORS

Adjustable and multi-position wing snowplows offer unmatched versatility, letting operators automatically adjust the wings to the most efficient plowing configuration for the job. Adjustable wing plows offer the most control and maneuverability by allowing the wings to move into retracted straight, expanded straight, windrow and scoop positions, all at the touch of a button. Whether plowing in large areas or tighter spaces, get more jobs done faster with winged plow efficiency.

UltraMount 2 attachment kits for tractors are available for the following WESTERN winged plow models:

- PRODIGY™
- WIDE-OUT™ (8'-10' model)

EASY INSTALLATION

Designed for a wide range of tractor models, the UltraMount 2 attachment kits have a removal push beam that allows for easy attachment to and removal from tractors. Plus, there is no need to uninstall the mount to reattach the loader system after plowing. The mount kit will come standard with a control harness and battery cable needed to operate FLEET FLEX enabled WESTERN snowplows.

LIGHT KIT (ACCESSORY)

The light kit includes a switch and harness to be installed on the machine and will operate either LED or dual-halogen NIGHTHAWK™ headlamps.

MORE JOBS. **DONE FASTER.**

2 WINTER WARRANTY

Western Products reserves the right under its product improvement policy to change construction or design details and furnish equipment when so altered without reference to illustrations or specifications used. Western Products or the vehicle manufacturer may require or recommend optional equipment for snow removal. Do not exceed vehicle ratings with a snowplow. Western Products offers a limited warranty for all snowplows and accessories. See separately printed page for this important information. The following are registered (®) or unregistered (™) trademarks of Douglas Dynamics, LLC: CONTRACTOR GRADE®, EdgeView™, MVP 3™, NIGHTHAWK™, PRODIGY™, PRO-PLOW® Series 2, PRO PLUS®, WIDE-OUT™, UltraMount® 2, WESTERN®.

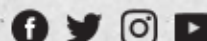

westernplows.com

Printed in U.S.A. | FORM NO. 79279-MR20

dd A DIVISION OF DOUGLAS DYNAMICS, LLC

Western Products | P.O. Box 245038 | Milwaukee, WI 53224-9C38

©2020 Douglas Dynamics, LLC. All rights reserved.



Western Products | P.O. Box 245038 | Milwaukee, WI 53224-9538

TWO WINTER WARRANTY

westernplows.com



Western Products reserves the right under its product improvement policy to change construction or design details and furnish equipment when so altered without reference to illustrations or specifications used. Western Products or the vehicle manufacturer may require or recommend optional equipment for snow removal. Do not exceed vehicle ratings with a snowplow. This product is manufactured under the following US patents: 6,408,549; 6,412,199; 6,526,677; 6,711,837; 6,928,757; 6,941,685; 7,134,227; 7,400,058; 7,430,821; 7,737,576; 8,850,724; 9,200,418; 9,822,563; CAN patents: 2,358,145; 2,358,354; 2,639,052; and other patents pending. Western Products offers a limited warranty for all snowplows and accessories. See separately printed page for this important information. The following are registered (®) or unregistered (™) trademarks of Douglas Dynamics, LLC: "CONTRACTOR GRADE", "DEFENDER", "EdgeView"™ technology, "EXTREME DEFENSE", "FLEX ARM", "HTS", "IMPACT", "MIDWEIGHT", "MVP 3", "MVP PLUS", "NIGHTHAWK", "PILE DRIVER", "PRO-PLOW" Series 2, "PRO PLUS", "PRO PLUS" HD, "PRODIGY", "Roll-Action", "SECURITY GUARD", "Striker", "Tornado" UTV, "ULTRAFINISH", "UltraMount", "UltraMount" 2, "WESTERN", "WIDE-OUT" and "WIDE-OUT" XL.

©2019 Douglas Dynamics, LLC
All rights reserved.

 A DIVISION OF DOUGLAS DYNAMICS, LLC

Printed in U.S.A.
Form No. 72832 - AU19