



TRUCK TOOL BOXES



See page 26 for Black Aluminum Underbody

NOTHING WORKS LIKE A DOGG®

Our History



1946
Buyers Products Company founded by Sam Ruven and Bessie Kleinman as a distributor of driveline components.

Tacom

1992 Buyers acquired Trailer Components Manufacturing (Tacom) for CNC precision machining and tooling, as well as state-of-the-art welding.

Buyers

Buyers continued to grow its product offerings and build valued relationships with customers and suppliers. Increased demand for products led to the pursuit of supply chain manufacturing solutions.

PROGRESSIVE
POWDER COATING, INC.

1995 Buyers acquired Progressive Powder Coating. Our Nordson automatic powder application booth is used to powder coat our Buyers toolboxes and other truck and trailer accessories.

Buyers
PRODUCTS COMPANY

2002 Buyers moved its corporate headquarters to a brand new 235,000 sq. ft. state-of-the-art office and distribution center.

Romotech
ROTATIONAL MOLDING TECHNOLOGIES, INC.

2004 Buyers acquired Romotech in New Paris, Indiana. Our Ferry Industries Rotospeed molding machines are used to manufacture our poly salt spreaders.

SnowDogg
Buyers

2007 Buyers began manufacturing the SnowDogg stainless steel snowplow at our Mentor, Ohio facility.

Boomerang
RUBBER, INC.

2009 Buyers began our operations at Boomerang Rubber, in Botkins, Ohio manufacturing mudflaps, wheel chocks and other rubber truck and trailer accessories.

Buyers
PRODUCTS COMPANY

2013 Buyers acquired an additional 500,000 sq. ft. manufacturing facility in Mentor, Ohio allowing for expansion of our aluminum and stainless steel manufacturing.

SaltDogg
Buyers

Buyers
PRODUCTS COMPANY

2016 Buyers establishes a 22,000 sq ft Engineering Tech Center in Mentor, Ohio. It's multi-use lab, design, training and prototyping space is dedicated to the research and development of innovative product.

**ALL YOUR WORK
TRUCK PRODUCTS
ALL THE TIME.**

2017 Buyers launches new website with business partner portal, to make online ordering and account maintenance easy for customers.

Buyers
PRODUCTS COMPANY

2021 Buyers adds almost 300,000 sq ft of additional, state-of-the-art warehouse and office space to maintain the quick turnaround and competitive value their customers expect.

Our Corporate Family of Companies



Founded in 1946, Buyers Products is a fully integrated manufacturer and a leader in the truck equipment industry. Our engineering, manufacturing and assembly operations take place in the USA, under the Buyers family of companies. **Buyers Products' mission is to improve our Customers' profitability and productivity while enhancing the quality of our products and services.**





PRODUCT HIGHLIGHTS:

UNDERBODY 4-31

- XD Steel..... 6-7
- Steel 8-17
- XD Aluminum..... 18-23
- Aluminum 24-29
- Polymer 29
- Mounting Brackets..... 30-31

TOPSIDER 32-41

- XD Steel..... 34
- Steel 34-35
- Aluminum 36-41

BACKPACK..... 42-00

- Four Door Offset..... 44-45
- Four Door Flat 46-47
- Two Door Offset 48-49
- Two Door Flat 50-51
- L-Pack..... 52-53
- Underbody Boxes 54-55
- Accessories..... 56-57

IN-BED STORAGE..... 58-00

- Crossover 60-62
- Wheel Well..... 63
- Lo-Sider..... 64-65
- Storage Chests 66-69

TRAILER TONGUE 70-71

CLASS 8 BOXES 72-75

PARTS & ACCESSORIES..... 76-78

DISPLAYS 79

REPLACEMENT PARTS 80-81

INDEX 82-83

NEW ALUMINUM TOPSIDER

Additional sizes now available

pg. 37



1722556

COMPLETELY REDESIGNED CROSSOVER SERIES

pg. 61



1739410

NEW XD STEEL UNDERBODY

pg. 7



1752805



UNDE



UNDERBODY

XD Steel Underbodies

Buyers' Toughest Line of Boxes Built for Heavy Duty Commercial Use

Available Q4 2021

NEW DESIGN



12 gauge powder-coated steel box and door

Built-in rain gutter and automotive D-bulb seal

Stainless steel bolt-on continuous hinge with oversized 1/4" pin

Detachable 3/16" chains

Single-point latch system with compression sealing roller

XD Steel Features



Cross-broke door for added durability



Detachable 3/16 in. door chains



Stainless steel bolt-on continuous hinge with oversized 1/4" pin



Built-in rain gutter

- 12 gauge steel box and cross-broke door
- Patent pending removable door design
- Automotive D-bulb seal
- Stainless steel bolt-on continuous hinge with oversized 1/4" pin
- Built-in rain gutter
- Detachable 3/16" door chains
- Locking die cast T-handle compression latch



Black, Single Latch



Part No.	Height	Depth	Width	# Latches per Door	Wt. (lb)	Cat.
1752800*	18	18	24	1	80	530 (Y)
1752803*	18	18	30	1	91	530 (Y)
1752805*	18	18	36	1	104	530 (Y)
1752810*	18	18	48	1	127	530 (Y)
1754800*	24	24	24	1	90	530 (Y)
1754803*	24	24	30	1	115	530 (Y)
1754805*	24	24	36	1	132	530 (Y)

Black, Double Door

Works great as Toppersider on flatbeds and service bodies.



Part No.	Height	Depth	Width	# Latches per Door	Wt. (lb)	Cat.
1752815*†	18	18	60	1	175	530 (Y)
1752825*†	18	18	72	1	202	530 (Y)
1752835*†	18	18	90	1	228	530 (Y)
1752836*†	18	18	96	2	250	530 (Y)

†Boxes can be used as toppersiders and underbodies

Steel Underbodies



14 gauge powder-coated steel box with 12 gauge steel door

Replaceable gasket sealing system

Bolt-on, stainless steel continuous hidden hinge

Aircraft grade door cables

Drop-down recessed door

1702305

Steel Features



Bolt-on, stainless steel continuous hidden hinge



Replaceable gasket sealing system

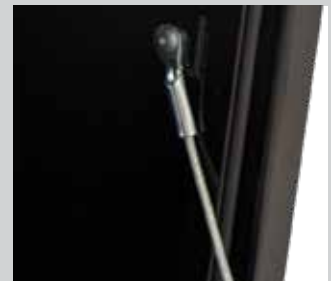

Aircraft grade door cables

T-HANDLE LATCH

- 14 gauge powder-coated steel box with 12 gauge steel door
- Drop-down recessed door
- Locking stainless steel T-handle latches
- Bolt-on, stainless steel continuous hidden hinge
- Replaceable gasket sealing system
- Aircraft grade door cables
- Reinforced door backbone on boxes 48" and wider
- Door opening: flat surface mount (90°) or underbody mount (180°)

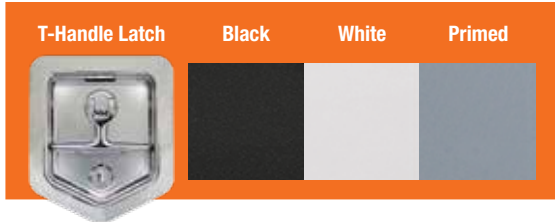

Black, Single Latch



Part No.	Height	Depth	Width	# Latches per Door	Wt. (lb)	Cat.
1703349	14	12	18	1	37	530 (Y)
1703350	14	12	24	1	40	530 (Y)
1703353	14	12	30	1	49	530 (Y)
1703300	14	16	24	1	56	530 (Y)
1703303	14	16	30	1	65	530 (Y)
1703305	14	16	36	1	74	530 (Y)
1703310	15	10	15	1	28	530 (Y)
1703312	15	10	24	1	39	530 (Y)
1703320	15	13	15	1	32	530 (Y)
1703322	15	13	24	1	45	530 (Y)
1703324	15	13	30	1	53	530 (Y)
1703326	15	13	36	1	61	530 (Y)
1703330	16	14	18	1	50	530 (Y)
1702295	18	18	18	1	47	530 (Y)
1702300	18	18	24	1	67	530 (Y)
1702303	18	18	30	1	80	530 (Y)
1702305	18	18	36	1	92	530 (Y)
1704300	24	24	24	1	87	530 (Y)
1704303	24	24	30	1	100	530 (Y)
1704305	24	24	36	1	116	530 (Y)

Black, Dual Latch



Part No.	Height	Depth	Width	# Latches per Door	Wt. (lb)	Cat.
1703328*	15	13	48	2	83	530 (Y)
1702310	18	18	48	2	118	530 (Y)
1702315	18	18	60	2	143	530 (Y)
1702317	18	18	66	2	186	530 (Y)
1708310	18	24	48	2	133	530 (Y)
1704310	24	24	48	2	145	530 (Y)
1704315	24	24	60	2	175	530 (Y)

Black, Double Door



Part No.	Height	Depth	Width	# Latches per Door	Wt. (lb)	Cat.
1702325†	18	18	72	1	156	530 (Y)

†Boxes can be used as topsiders and underbodies

Steel Underbody

White, Single Latch



Part No.	Height	Depth	Width	# Latches per Door	Wt. (lb)	Cat.
1703400	14	16	24	1	56	530 (Y)
1703403	14	16	30	1	65	530 (Y)
1703405	14	16	36	1	71	530 (Y)
1703495	18	18	18	1	47	530 (Y)
1702400	18	18	24	1	67	530 (Y)
1702403	18	18	30	1	80	530 (Y)
1702405	18	18	36	1	92	530 (Y)
1704400	24	24	24	1	87	530 (Y)
1704403	24	24	30	1	100	530 (Y)
1704405	24	24	36	1	116	530 (Y)

White, Dual Latch



Part No.	Height	Depth	Width	# Latches per Door	Wt. (lb)	Cat.
1702410	18	18	48	2	118	530 (Y)
1702415	18	18	60	2	143	530 (Y)
1702417	18	18	66	2	186	530 (Y)
1708410	18	24	48	2	133	530 (Y)
1704410	24	24	48	2	145	530 (Y)
1704415	24	24	60	2	175	530 (Y)

Primed, Single Latch



Part No.	Height	Depth	Width	# Latches per Door	Wt. (lb)	Cat.
1703900	14	16	24	1	56	530 (Y)
1702900	18	18	24	1	67	530 (Y)
1702905	18	18	36	1	92	530 (Y)

Primed, Dual Latch



Part No.	Height	Depth	Width	# Latches per Door	Wt. (lb)	Cat.
1702910	18	18	48	2	118	530 (Y)

T-HANDLE LATCH WITH SHELF

- 14 gauge steel box with 12 gauge steel door
- 14 gauge steel shelf welded at mid height, 12-3/4" deep with 1" front lip
- Locking stainless steel T-handle latches
- Aircraft grade door cables
- Replaceable gasket sealing system

Black



1703304

White



1703404

T-HANDLE LATCH WITH SLANTED BACK

- Angled top allows room for fuel fill hoses on single rear wheel flat beds
- Locking stainless steel T-handle latches
- Door opening: flat surface mount (90°) or underbody mount (180°)
- Drop-down recessed door
- Replaceable gasket sealing system

Black



1703351



Profile



Part No.	Height	Depth	Width	# Latches per Door	Lanyards	Wt. (lb)	Cat.
1703304	14	16	30	1	Y	72	530 (Y)
1702306*†	18	18	36	1	N	82	530 (Y)
1702311*†	18	18	48	1	N	106	530 (Y)

†These have 3-Point Compression Latches and no Lanyards

Part No.	Height	Depth	Width	# Latches per Door	Lanyards	Wt. (lb)	Cat.
1703404	14	16	30	1	Y	72	530 (Y)
1702406†	18	18	36	1	N	82	530 (Y)
1702411†	18	18	48	1	N	106	530 (Y)

†These have 3-Point Compression Latches and no Lanyards



Part No.	Height	Depth	Width	# Latches per Door	Wt. (lb)	Cat.
1703351	14	12	18	1	40	530 (Y)
1703352	14	12	24	1	47	530 (Y)
1703355	14	12	30	1	49	530 (Y)

Steel Underbody

PADDLE LATCH

- 14 gauge powder-coated steel box with 12 gauge steel door
- Drop-down recessed door
- Locking stainless steel paddle latch
- Continuous bolt-on hidden hinge
- Replaceable gasket sealing system
- Aircraft grade door cables
- Reinforced door backbone on boxes 48" and wider
- Door opening: flat surface mount (90°) or underbody mount (180°)



Black, Single Latch



Part No.	Height	Depth	Width	# Latches per Door	Wt. (lb)	Cat.
1703150	14	12	24	1	48	530 (Y)
1703100	14	16	24	1	56	530 (Y)
1703103	14	16	30	1	65	530 (Y)
1702100	18	18	24	1	67	530 (Y)
1702103	18	18	30	1	80	530 (Y)
1702105	18	18	36	1	92	530 (Y)

Black, Dual Latch



Part No.	Height	Depth	Width	# Latches per Door	Wt. (lb)	Cat.
1702110	18	18	48	2	118	530 (Y)
1702115	18	18	60	2	143	530 (Y)

White, Single Latch



Part No.	Height	Depth	Width	# Latches per Door	Wt. (lb)	Cat.
1703203	14	16	30	1	65	530 (Y)
1703205	14	16	36	1	74	530 (Y)
1702200	18	18	24	1	67	530 (Y)
1702203	18	18	30	1	80	530 (Y)
1702205	18	18	36	1	92	530 (Y)

White, Dual Latch



Part No.	Height	Depth	Width	# Latches per Door	Wt. (lb)	Cat.
1702210	18	18	48	2	118	530 (Y)
1702215	18	18	60	2	143	530 (Y)

3-POINT COMPRESSION LATCH

- 14 gauge powder-coated steel box with 12 gauge steel door
- Drop-down recessed door
- Die-cast T-handle compression latch with 3-point locking system
- Bolt-on continuous hidden hinge
- Replaceable gasket sealing system
- Aircraft grade door cables
- Reinforced door backbone on boxes 48" and wider
- Door opening: flat surface mount (90°) or underbody mount (180°)



Black



Part No.	Height	Depth	Width	# Latches per Door	Wt. (lb)	Cat.
1732300	18	18	24	1	59	530 (Y)
1732303	18	18	30	1	70	530 (Y)
1732305	18	18	36	1	83	530 (Y)
1732310	18	18	48	1	118	530 (Y)
1732315	18	18	60	1	143	530 (Y)
1734300	24	24	24	1	84	530 (Y)
1734303	24	24	30	1	95	530 (Y)
1734305	24	24	36	1	110	530 (Y)

White



Part No.	Height	Depth	Width	# Latches per Door	Wt. (lb)	Cat.
1732400	18	18	24	1	59	530 (Y)
1732403	18	18	30	1	70	530 (Y)
1732405	18	18	36	1	83	530 (Y)
1734400	24	24	24	1	84	530 (Y)
1734403	24	24	30	1	95	530 (Y)
1734405	24	24	36	1	110	530 (Y)
1702406†	18	18	36	1	82	530 (Y)
1702411†	18	18	48	1	106	530 (Y)

†Includes shelf (see page 11)

Textured Matte Black



Part No.	Height	Depth	Width	# Latches per Door	Wt. (lb)	Cat.
1732500	18	18	24	1	59	530 (Y)
1732503	18	18	30	1	70	530 (Y)
1732505	18	18	36	1	83	530 (Y)
1732510	18	18	48	1	118	530 (Y)
1734500	24	24	24	1	84	530 (Y)
1734503	24	24	30	1	95	530 (Y)
1734505	24	24	36	1	110	530 (Y)

Steel Underbody

POLISHED STAINLESS STEEL DOOR WITH COMPRESSION LATCH

- 14 gauge steel or stainless box with 12 gauge steel door or polished 16 gauge stainless steel door
- Drop-down recessed door
- Locking die-cast T-handle compression latch
- Continuous hidden hinge
- Replaceable gasket sealing system
- Aircraft grade door cables
- Reinforced door backbone on boxes 48" and wider
- Door opening: flat surface mount (90°) or underbody mount (180°)



Black Box, Single Latch



Part No.	Height	Depth	Width	# Latches per Door	Wt. (lb)	Cat.
1703700	14	16	24	1	55	530 (Y)
1703703	14	16	30	1	64	530 (Y)
1703705	14	16	36	1	71	530 (Y)
1702700	18	18	24	1	72	530 (Y)
1702703	18	18	30	1	81	530 (Y)
1702705	18	18	36	1	101	530 (Y)
1704705	24	24	36	1	132	530 (Y)

Black Box, Dual Latch



Part No.	Height	Depth	Width	# Latches per Door	Wt. (lb)	Cat.
1702710	18	18	48	2	110	530 (Y)
1702715	18	18	60	2	132	530 (Y)
1704710	24	24	48	2	169	530 (Y)
1704715	24	24	60	2	227	530 (Y)

Black Box, Double Door



Part No.	Height	Depth	Width	# Latches per Door	Wt. (lb)	Cat.
1702725	18	18	72	1	156	530 (Y)

Stainless Box, Single Latch



Part No.	Height	Depth	Width	# Latches per Door	Wt. (lb)	Cat.
1702595	18	18	18	1	51.5	530 (Y)
1702600	18	18	24	1	61.5	530 (Y)
1702603	18	18	30	1	81	530 (Y)
1702605	18	18	36	1	85	530 (Y)
1704600	24	24	24	1	87	530 (Y)
1704603	24	24	30	1	100	530 (Y)
1704605	24	24	36	1	116	530 (Y)

Stainless Box, Dual Latch



Part No.	Height	Depth	Width	# Latches per Door	Wt. (lb)	Cat.
1702610	18	18	48	2	110	530 (Y)
1704610	24	24	48	2	145	530 (Y)
1704615	24	24	60	2	175	530 (Y)



Steel Underbody

MIRROR FINISH STAINLESS STEEL DOOR WITH COMPRESSION LATCH

- 16 gauge high polish steel box and door
- Drop-down external door
- Locking die-cast T-handle compression latch
- Continuous hidden hinge
- Replaceable door cables
- Built-in rain gutter with automotive bulb seal

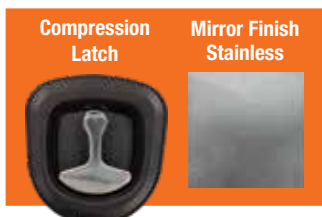

Single Latch



Part No.	Height	Depth	Width	# Latches per Door	Wt. (lb)	Cat.
1702650	18	18	24	1	48	530 (N)
1702653	18	18	30	1	57	530 (N)
1702655	18	18	36	1	65	530 (N)

Dual Latch



Part No.	Height	Depth	Width	# Latches per Door	Wt. (lb)	Cat.
1702660	18	18	48	2	80	530 (N)



DIAMOND TREAD ALUMINUM DOOR WITH COMPRESSION LATCH

- 14 gauge steel box with .100" thick diamond tread door
- Drop-down recessed door
- Locking die-cast T-handle compression latch
- Bolt-on continuous hidden hinge
- Replaceable gasket sealing system
- Aircraft grade door cables
- Door opening: flat surface mount (90°) or underbody mount (180°)
- Reinforced door backbone on boxes 48" and wider



Black, Single Latch



Part No.	Height	Depth	Width	# Latches per Door	Wt. (lb)	Cat.
1702500	18	18	24	1	61	530 (Y)
1702503	18	18	30	1	72	530 (Y)
1702505	18	18	36	1	82	530 (Y)

Black, Dual Latch



Part No.	Height	Depth	Width	# Latches per Door	Wt. (lb)	Cat.
1702510	18	18	48	2	104	530 (Y)



XD Aluminum Underbodies

Buyers' Toughest Line of Boxes Built for Heavy Duty Commercial Use



Rigid extruded box frame and automotive bulb seal

Stainless steel bolt-on continuous hinge with oversized 1/4" pin

1705435

Interlocking barn door channel with seal

.125" thick smooth aluminum

Die-cast T-handle compression latch with 3-point locking system

Unobstructed box opening

1706405

3-point locking system on drop door

XD Aluminum Features



Die-cast T-handle compression latch with 3-point locking system



Rain gutter for added protection



Rigid extruded box frame and automotive bulb seal



Unobstructed box opening



XD Aluminum Underbody

SMOOTH ALUMINUM BARN DOOR WITH COMPRESSION LATCH

- .125" thick smooth aluminum with rigid extruded box frame
- Locking die-cast T-handle compression latch
- 3 point locking system on double barn doors, standard lock system on single swing door
- Stainless steel bolt-on continuous hinge with oversized 1/4" pin
- Built-in rain gutter with automotive bulb seal
- Unobstructed box opening with no center post

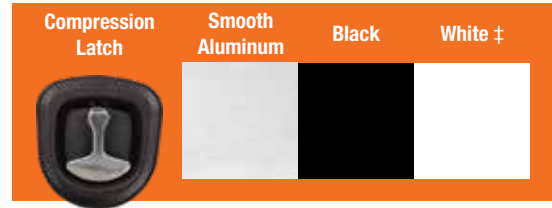

Smooth Aluminum



Part No.	Height	Depth	Width	# Doors	Wt. (lb)	Cat.
1705395*	18	18	18	1	56.5	530 (Y)
1705401*	18	18	24	1	56.5	530 (Y)
1705431*	24	24	24	1	67	530 (Y)
1705403*	18	18	30	2	45	530 (Y)
1705405	18	18	36	2	51	530 (Y)
1705410	18	18	48	2	62	530 (Y)
1705415	18	18	60	2	73	530 (Y)
1705420	18	24	36	2	58	530 (Y)
1705425	18	24	48	2	71	530 (Y)
1705430	18	24	60	2	85	530 (Y)
1705433*	24	24	30	2	62	530 (Y)
1705435	24	24	36	2	67	530 (Y)
1705440	24	24	48	2	83	530 (Y)
1705445	24	24	60	2	99	530 (Y)
1705450	24	24	72	2	105	530 (Y)

Black



Part No.	Height	Depth	Width	# Doors	Wt. (lb)	Cat.
1705895*	18	18	18	1	56.5	530 (Y)
1705900*	18	18	24	1	56.5	530 (Y)
1705931*	24	24	24	1	67	530 (Y)
1705903*	18	18	18	2	45	530 (Y)
1705905	18	18	36	2	51	530 (Y)
1705910	18	18	48	2	62	530 (Y)
1705915	18	18	60	2	73	530 (Y)
1705920	18	24	36	2	58	530 (Y)
1705925	18	24	48	2	71	530 (Y)
1705930	18	24	60	2	85	530 (Y)
1705933*	24	24	30	2	62	530 (Y)
1705935	24	24	36	2	67	530 (Y)
1705940	24	24	48	2	83	530 (Y)
1705945	24	24	60	2	99	530 (Y)
1705950	24	24	72	2	105	530 (Y)

XD Aluminum Underbody

White ‡



Part No.	Height	Depth	Width	# Doors	Wt. (lb)	Cat.
1706895*	18	18	18	1	56.5	530 (Y)
1706900*	18	18	24	1	56.5	530 (Y)
1706931*	24	24	24	1	67	530 (Y)
1706903* ‡	18	18	30	2	45	530 (Y)
1706905‡	18	18	36	2	51	530 (Y)
1706910‡	18	18	48	2	62	530 (Y)
1706915‡	18	18	60	2	73	530 (Y)
1706920‡	18	24	36	2	58	530 (Y)
1706925‡	18	24	48	2	71	530 (Y)
1706930‡	18	24	60	2	85	530 (Y)
1706933* ‡	24	24	30	2	62	530 (Y)
1706935‡	24	24	36	2	67	530 (Y)
1706940‡	24	24	48	2	83	530 (Y)
1706945‡	24	24	60	2	99	530 (Y)
1706950‡	24	24	72	2	105	530 (Y)



‡ White is not stocked. Please call for lead time.

See pg. 30-31 for Underbody Mounting Brackets

XD Aluminum Underbody

DROP DOOR WITH 3-POINT COMPRESSION LATCH

- .125" thick smooth aluminum with rigid extruded box frame (.100" thick diamond tread aluminum door on certain models)
- Die-cast T-handle compression latch with 3-point locking system
- Stainless steel bolt-on continuous hinge with oversized 1/4" pin
- Built-in rain gutter with automotive bulb seal

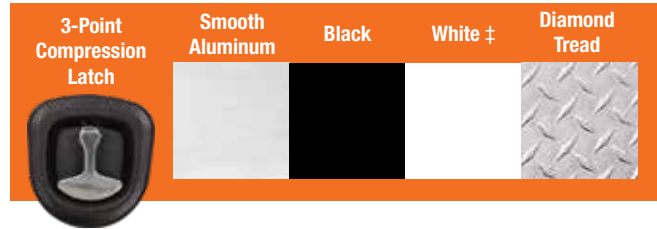

Smooth Aluminum



Part No.	Height	Depth	Width	# Latches per Door	Wt. (lb)	Cat.
1706400	18	18	24	1	43.80	530 (Y)
1706403	18	18	30	1	50.45	530 (Y)
1706405	18	18	36	1	56.70	530 (Y)
1706410	18	18	48	1	64.45	530 (Y)
1706415	18	18	60	1	77.80	530 (Y)
1706420	18	24	36	1	56.68	530 (Y)
1706425	18	24	48	1	78.87	530 (Y)
1706430	18	24	60	1	82.70	530 (Y)

Black



Part No.	Height	Depth	Width	# Latches per Door	Wt. (lb)	Cat.
1706960	18	18	24	1	43.80	530 (Y)
1706963	18	18	30	1	50.45	530 (Y)
1706965	18	18	36	1	56.70	530 (Y)
1706970	18	18	48	1	64.45	530 (Y)
1706975	18	18	60	1	77.80	530 (Y)
1706980	18	24	36	1	56.68	530 (Y)
1706985	18	24	48	1	78.87	530 (Y)
1706990	18	24	60	1	82.70	530 (Y)

White‡



Part No.	Height	Depth	Width	# Latches per Door	Wt. (lb)	Cat.
1707960‡	18	18	24	1	43.80	530 (Y)
1707963‡	18	18	30	1	50.45	530 (Y)
1707965‡	18	18	36	1	56.70	530 (Y)
1707970‡	18	18	48	1	64.45	530 (Y)
1707975‡	18	18	60	1	77.80	530 (Y)
1707980‡	18	24	36	1	56.68	530 (Y)
1707985‡	18	24	48	1	78.87	530 (Y)
1707990‡	18	24	60	1	82.70	530 (Y)

‡ White is not stocked. Please call for lead time.

XD Aluminum/Aluminum Underbody with Drawers

Diamond Tread Door



Part No.	Height	Depth	Width	# Latches per Door	Wt. (lb)	Cat.
1706500	18	18	24	1	41	530 (Y)
1706503	18	18	30	1	48	530 (Y)
1706505	18	18	36	1	56	530 (Y)
1706510	18	18	48	1	69	530 (Y)
1706515	18	18	60	1	78.8	530 (Y)
1706520	18	24	36	1	66.6	530 (Y)
1706525	18	24	48	1	79.8	530 (Y)
1706530	18	24	60	1	83.7	530 (Y)

ALUMINUM UNDERBODY WITH DRAWERS

- .100" thick diamond tread aluminum
- Drawer comes with adjustable dividers and 100 lb rated 16" slides
- Drop-down recessed door
- Locking die-cast T-handle compression latch
- Continuous hidden hinge
- Replaceable gasket sealing system
- Door opening: flat surface mount (90°) or underbody mount (180°)
- Reinforced door backbone
- Aircraft grade door cables



Part No.	Height	Depth	Width	# Latches per Door	Wt. (lb)	Cat.
1712200	20	18	24	1	50	530 (Y)
1712205	20	18	36	1	66	530 (Y)
1712210	20	18	48	1	85	530 (Y)

Aluminum Underbodies

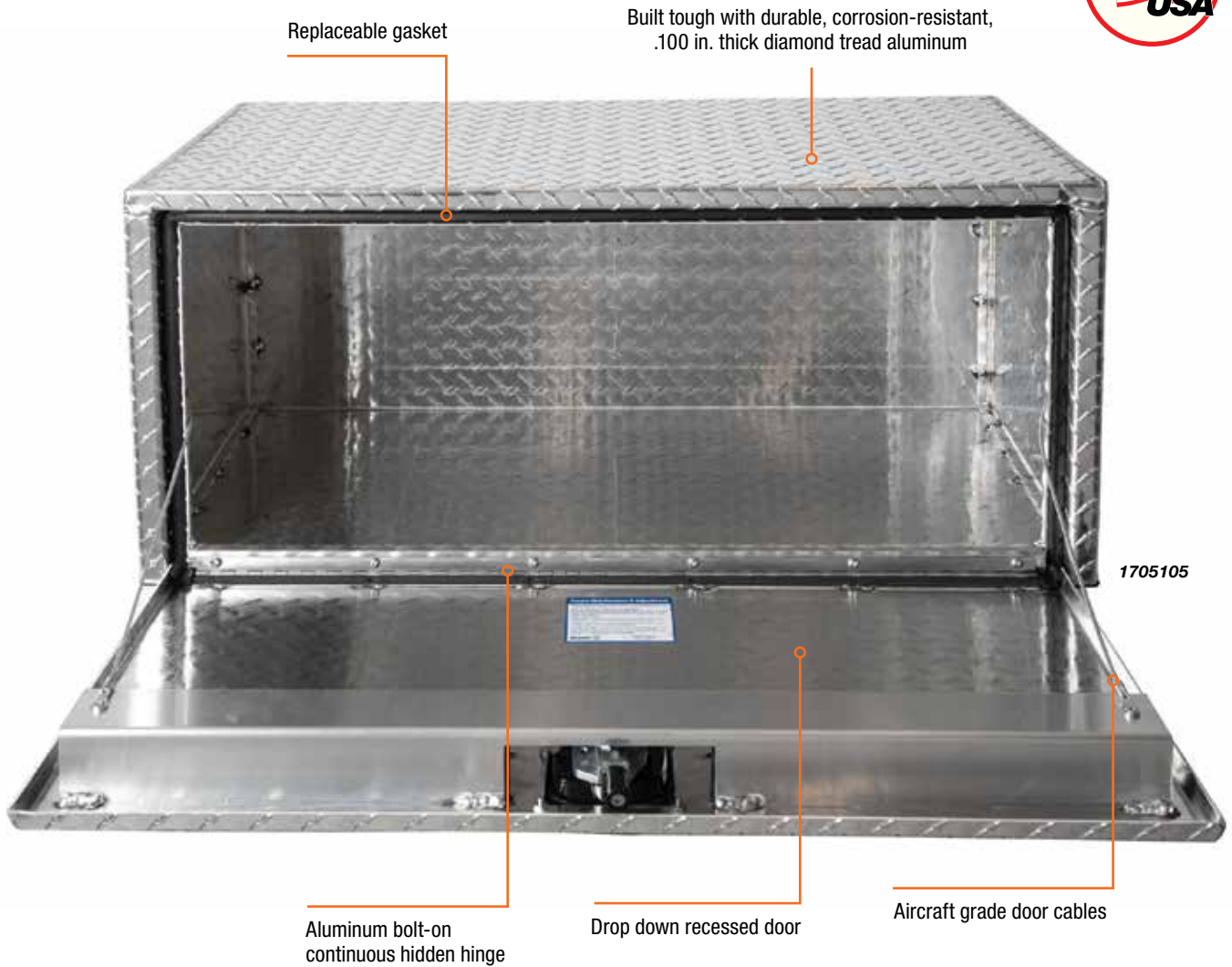

Aluminum Features



Replaceable gasket



Aluminum bolt-on continuous hidden hinge



Aircraft grade door cables

COMPRESSION LATCH

- .100" thick diamond tread aluminum
- Drop-down recessed door
- Locking die-cast T-handle compression latch
- Aluminum bolt-on continuous hidden hinge
- Replaceable gasket sealing system
- Aircraft grade door cables
- Reinforced door backbone on boxes 48" and wider
- Door opening: flat surface mount (90°) or underbody mount (180°)



Diamond Tread, Single Latch



Part No.	Height	Depth	Width	# Latches per Door	Wt. (lb)	Cat.
1705148	14	12	16	1	18	530 (Y)
1705149	14	12	18	1	19	530 (Y)
1705150	14	12	24	1	23	530 (Y)
1705153	14	12	30	1	26	530 (Y)
1705160	14	16	24	1	25	530 (Y)
1705102	18	18	14	1	24.6	530 (Y)
1705101	18	18	18	1	30	530 (Y)
1705100	18	18	24	1	32.5	530 (Y)
1705103	18	18	30	1	38.5	530 (Y)
1705105	18	18	36	1	43	530 (Y)
1705118	20	20	36	1	46	530 (Y)
1705119	18	24	36	1	56	530 (Y)
1705130	24	24	24	1	45	530 (Y)
1705133	24	24	30	1	52	530 (Y)
1705135	24	24	36	1	59.5	530 (Y)

Diamond Tread, Dual Latch



Part No.	Height	Depth	Width	# Latches per Door	Wt. (lb)	Cat.
1705110	18	18	48	2	56.5	530 (Y)
1705115	18	18	60	2	66	530 (Y)
1705120	18	24	48	2	63.5	530 (Y)
1705125	18	24	60	2	82	530 (Y)
1705140	24	24	48	2	75	530 (Y)
1705145	24	24	60	2	88.5	530 (Y)
1705147	24	24	72	2	97	530 (Y)

Aluminum Underbody

Black Diamond Tread, Single Latch



Part No.	Height	Depth	Width	# Latches per Door	Wt. (lb)	Cat.
1725148	14	12	16	1	18	530 (Y)
1725149	14	12	18	1	22.5	503 (Y)
1725150	14	12	24	1	22.5	530 (Y)
1725153	14	12	30	1	27	530 (Y)
1725160	14	16	24	1	26	530 (Y)
1725102	18	18	14	1	27	530 (Y)
1725101	18	18	18	1	27	530 (Y)
1725100	18	18	24	1	30	530 (Y)
1725103	18	18	30	1	38	530 (Y)
1725105	18	18	36	1	42	530 (Y)
1725116	18	24	30	1	39.7	530 (Y)
1725119	18	24	36	1	56	530 (Y)
1725125	18	24	60	1	64	530 (Y)
1725118	20	20	36	1	64	530 (Y)
1725130	24	24	24	1	46	530 (Y)
1725133	24	24	30	1	53	530 (Y)
1725135	24	24	36	1	59	530 (Y)

Black Diamond Tread, Dual Latch



Part No.	Height	Depth	Width	# Latches per Door	Wt. (lb)	Cat.
1725110	18	18	48	2	52	530 (Y)
1725115	18	18	60	2	70	530 (Y)
1725120	18	24	48	2	64	530 (Y)
1725140	24	24	48	2	76	530 (Y)
1725145	24	24	60	2	89	530 (Y)
1725147	24	24	72	2	97	530 (Y)

Textured Matte Black Diamond Tread, Single Latch



Part No.	Height	Depth	Width	# Latches per Door	Wt. (lb)	Cat.
1715100	18	18	24	1	30	530 (Y)
1715105	18	18	36	1	42	530 (Y)

Textured Matte Black Diamond Tread, Dual Latch



Part No.	Height	Depth	Width	# Latches per Door	Wt. (lb)	Cat.
1715110	18	18	48	2	52	530 (Y)
1715115	18	18	60	2	70	530 (Y)

3-POINT COMPRESSION LATCH

- .100" thick diamond tread aluminum
- Drop-down recessed door
- Die-cast T-handle compression latch with 3-point locking system
- Aluminum bolt-on continuous hidden hinge
- Replaceable gasket sealing system
- Aircraft grade door cables
- Reinforced door backbone
- Door opening: flat surface mount (90°) or underbody mount (180°)



Diamond Tread

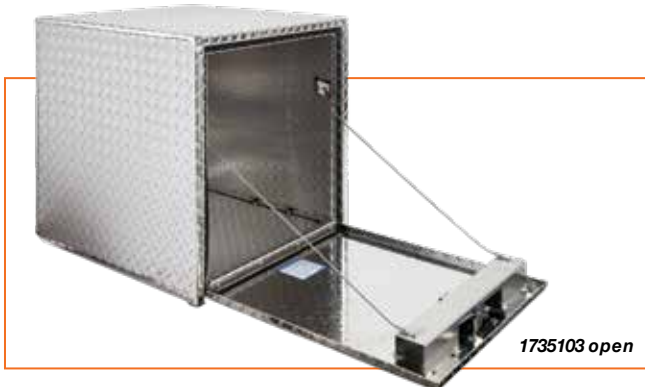

Part No.	Height	Depth	Width	# Latches per Door	Wt. (lb)	Cat.
1735100	18	18	24	1	32.5	530 (Y)
1735103	18	18	30	1	38	530 (Y)
1735105	18	18	36	1	44	530 (Y)
1735130	24	24	24	1	45	530 (Y)
1735133	24	24	30	1	58	530 (Y)
1735135	24	24	36	1	63	530 (Y)



Aluminum Underbody

BARN DOOR WITH COMPRESSION LATCH

- 0.100" thick diamond tread or smooth aluminum
- Side-hinged doors with reversible right/left locking door
- Locking die-cast T-handle compression latch
- 3 point locking system on double barn doors, standard lock system on single swing door
- Aluminum bolt-on continuous hinge with oversize 1/4" pin
- Automotive D-bulb seal
- Can mount on flat surface
- Unobstructed box opening with no center post

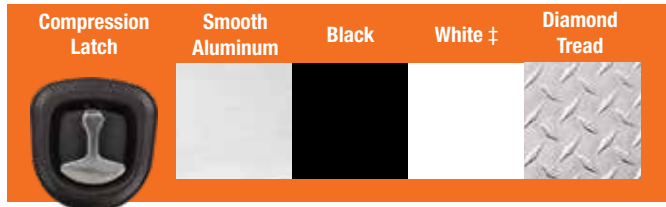

Smooth Aluminum



1705305

Black



1705840

White ‡



1706845

Part No.	Height	Depth	Width	# Doors	Wt. (lb)	Cat.
1705295*	18	18	18	1	26	530 (Y)
1705300*	18	18	24	1	32	530 (Y)
1705325*	24	24	24	1	43	530 (Y)
1705303	18	18	30	2	42	530 (Y)
1705305	18	18	36	2	49	530 (Y)
1705310	18	18	48	2	63	530 (Y)
1705315	18	18	60	2	77	530 (Y)
1705333	24	24	30	2	69	530 (Y)
1705335	24	24	36	2	75	530 (Y)
1705340	24	24	48	2	87	530 (Y)
1705345	24	24	60	2	99	530 (Y)
1705350	24	24	72	2	98	530 (Y)

Part No.	Height	Depth	Width	# Doors	Wt. (lb)	Cat.
1705795*	18	18	18	1	26	530 (Y)
1705800*	18	18	24	1	32	530 (Y)
1706825*	24	24	24	1	43	530 (Y)
1705803	18	18	30	2	42	530 (Y)
1705805	18	18	36	2	49	530 (Y)
1705810	18	18	48	2	63	530 (Y)
1705815	18	18	60	2	77	530 (Y)
1705833	24	24	30	2	69	530 (Y)
1705835	24	24	36	2	75	530 (Y)
1705840	24	24	48	2	87	530 (Y)
1705845	24	24	60	2	99	530 (Y)
1705850	24	24	72	2	98	530 (Y)

Part No.	Height	Depth	Width	# Doors	Wt. (lb)	Cat.
1706795*	18	18	18	1	26	530 (Y)
1706800*	18	18	24	1	32	530 (Y)
1706825*	24	24	24	1	43	530 (Y)
1706803‡	18	18	30	2	42	530 (Y)
1706805‡	18	18	36	2	49	530 (Y)
1706810‡	18	18	48	2	63	530 (Y)
1706815‡	18	18	60	2	77	530 (Y)
1706833‡	24	24	30	2	69	530 (Y)
1706835‡	24	24	36	2	75	530 (Y)
1706840‡	24	24	48	2	87	530 (Y)
1706845‡	24	24	60	2	99	530 (Y)
1706850‡	24	24	72	2	98	530 (Y)

‡ White is not stocked. Please call for lead time.

Aluminum/Polymer Underbody

Diamond Tread Aluminum



Part No.	Height	Depth	Width	# Doors	Wt. (lb)	Cat.
1705201	18	18	18	1	27	530 (Y)
1705200	18	18	24	1	36	530 (Y)
1705203	18	18	30	1	42	530 (Y)
1702225*	24	24	24	1	45	530 (Y)
1702230*	24	24	30	1	52	530 (Y)
1705205	18	18	36	2	49	530 (Y)
1705210	18	18	48	2	63	530 (Y)
1705215	18	18	60	2	77	530 (Y)
1702235	24	24	36	2	71	530 (Y)
1702240	24	24	48	2	76	530 (Y)
1702250	24	24	60	2	87	530 (Y)

Polymer Underbody

3-POINT T-HANDLE LATCH

Black, Single Latch

- Constructed of high-density polyethylene
- Drop down door
- Locking stainless steel 3-point T-handle latch
- Stainless steel hinge pin
- Replaceable gasket sealing system
- Aircraft grade door cables
- Molded double-wall door design



Part No.	Height	Depth	Width	# Latches per Door	Wt. (lb)	Cat.
1717100	18	18	24	1	24	530 (Y)
1717105	18	18	36	1	31	530 (Y)
1717110	18	18	48	1	42	530 (Y)

Underbody Mounting Brackets

STEEL

- Sold in boxed pairs
- Universal hole pattern for quick and easy mounting
- Available with welded braces or bolt-on braces
- Available in heavy-duty structural steel (optional)
- Constructed of formed (optional) 3" wide steel C-channel, black powder-coated for corrosion resistance
- Hardware not included

Formed, Welded



Part No.	Description	Height	Depth	Wt. (lb)	Cat.
1701006	Formed Welded Brackets	18	18	16	531 (Y)
1701011	Formed Welded Brackets	18	24	19	531 (Y)
1701016	Formed Welded Brackets	24	24	22	531 (Y)

Formed, Bolted



Part No.	Description	Height	Depth	Wt. (lb)	Cat.
1701006B	Formed Bolted Brackets	18	18	16	531 (Y)
1701011B	Formed Bolted Brackets	18	24	19	531 (Y)

Heavy Duty, Structural Welded



Part No.	Description	Height	Depth	Wt. (lb)	Cat.
1701005	Structural Welded Brackets	18	18	24	531 (Y)
1701010	Structural Welded Brackets	18	24	27	531 (Y)
1701015	Structural Welded Brackets	24	24	32	531 (Y)
1701012	Structural Welded Brackets	27	18	47	531 (Y)

Heavy Duty, Structural Bolted



Part No.	Description	Height	Depth	Wt. (lb)	Cat.
1701005B	Structural Bolted Brackets	18	18	24	531 (Y)
1701010B	Structural Bolted Brackets	18	24	27	531 (Y)

Underbody Mounting Brackets

STAINLESS STEEL

- Sold in boxed pairs
- Universal hole pattern for quick and easy mounting
- Welded braces
- 3/16" thick 304 stainless steel construction
- Hardware not included

Formed, Welded



1701031

Part No.	Description	Height	Depth	Wt. (lb)	Cat.
1701031	Welded Brackets	18	18	19	531 (Y)
1701041	Welded Brackets	18	24	22	531 (Y)

ALUMINUM

- Sold in boxed pairs
- Welded braces
- Aluminum construction
- 1/4" formed aluminum angles

Formed, Welded



1701030

Part No.	Description	Height	Depth	Wt. (lb)	Cat.
1701030	Welded Brackets	18	18	7.5	531 (Y)
1701040	Welded Brackets	24	24	10	531 (Y)

FOR POLYMER UNDERBODIES

- Sold in boxed pairs
- Constructed of 3/16" thick 2" wide C-channel A-36 steel
- Black powder-coated
- Channel fits inside toolbox ribs
- Pre-drilled 7/16" mounting holes (nuts/bolts not included)

Formed, Welded



1701000

Part No.	Description	Height	Depth	Wt. (lb)	Cat.
1701000	Brackets for 24" and 36" Poly	15	14	14.3	530 (Y)
1701001	Brackets for 48" Poly	15	14	22.3	530 (Y)



TO



TOPSIDER

Topsiders



XD STEEL TOPSIDERS

Black, Double Door

* See page 6-7 for details



Part No.	Height	Depth	Width	# Latches per Door	Wt. (lb)	Cat.
1752815*†	18	18	60	1	175	530 (Y)
1752825*†	18	18	72	1	202	530 (Y)
1752835*†	18	18	90	1	228	530 (Y)
1752836*†	18	18	96	2	250	530 (Y)

†Boxes can be used as topsiders and underbodies

T-HANDLE LATCH

- 16 gauge steel box with 14 gauge steel doors
- Drop-down recessed doors
- Locking stainless steel T-handle latches
- Bolt-on continuous hidden hinge
- Replaceable gasket sealing system
- Aircraft grade door cables
- Optional quick-mount trays
- Includes J-hooks for drill-free mounting and protective side rail pads
- Door opening: flat surface mount (90°)



Black

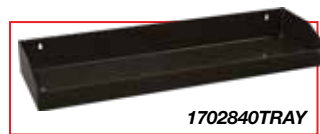

Part No.	Height	Depth	Width	# Latches per Door	Wt. (lb)	Cat.
1702940	16	13	72	1	115	530 (Y)
1702950	16	13	88	1	120	530 (Y)
1702960	16	13	96	2	128	530 (Y)
1702980*	18	16	72	1	118	530 (Y)
1702990*	18	16	88	1	136	530 (Y)
1703000*	18	16	90	1	150	530 (Y)
1703020*	18	16	96	2	151	530 (Y)

Optional Trays

Part No.	Height	Depth	Width	Wt. (lb)	Cat.
1702940TRAY	2.25/4	10.75	35	11	530 (Y)
1702950TRAY	2.25/4	10.75	43	14	530 (Y)
1702960TRAY	2.25/4	10.75	47	15	530 (Y)
1702980TRAY*	2.25/4	13.75	35	11.96	530 (Y)
1702990TRAY*	2.25/4	13.75	43	14.46	530 (Y)
1703000TRAY*	2.25/4	13.75	44	14.76	530 (Y)
1703020TRAY*	2.25/4	13.75	77	15.66	530 (Y)

White



Part No.	Height	Depth	Width	# Latches per Door	Wt. (lb)	Cat.
1702840	16	13	72	1	115	530 (Y)
1702850	16	13	88	1	120	530 (Y)
1702860	16	13	96	2	128	530 (Y)
1702880*	18	16	72	1	118	530 (Y)
1702890*	18	16	88	1	136	530 (Y)
1702895*	18	16	90	1	136	530 (Y)
1702920*	18	16	96	2	147	530 (Y)

Optional Trays

Part No.	Height	Depth	Width	Wt. (lb)	Cat.
1702840TRAY	2.25/4	10.75	35	11	530 (Y)
1702850TRAY	2.25/4	10.75	43	14	530 (Y)
1702860TRAY	2.25/4	10.75	47	15	530 (Y)
1702880TRAY*	2.25/4	13.75	35	11.96	530 (Y)
1702890TRAY*	2.25/4	13.75	43	14	530 (Y)
1702895TRAY*	2.25/4	13.75	44	14.76	530 (Y)
1702920TRAY *	2.25/4	13.75	77	15.66	530 (Y)

* **NEW** PRODUCTS

Aluminum Topsider

FLIP UP DOOR WITH COMPRESSION LATCH

- Gas shocks hold door open at 110°
- .100" thick diamond tread aluminum
- Locking die-cast T-handle compression latch
- Full length stainless steel bolt-on continuous hidden hinge
- Recessed door design with large 13" tall opening
- Integrated above door rain gutter
- Reinforced door backbone
- Replaceable gasket sealing system



Diamond Tread



Part No.	Height	Depth	Width	# Latches per Door	Wt. (lb)	Cat.
1701768	18	16	96	1	103	530 (Y)

Black



Part No.	Height	Depth	Width	# Latches per Door	Wt. (lb)	Cat.
1721768	18	16	96	1	103	530 (Y)

Matte Black



Part No.	Height	Depth	Width	# Latches per Door	Wt. (lb)	Cat.
1722768	18	16	96	1	103	530 (Y)

DIAMOND TREAD DROP DOOR WITH COMPRESSION LATCH

- .100" thick diamond tread aluminum
- Locking die-cast T-handle compression latch
- Full length stainless steel bolt-on continuous hidden hinge
- Replaceable gasket sealing system
- Aircraft grade door cables
- Includes J-hooks for drill-free mounting and protective side rail pads
- Door opening: flat surface mount (90°)



Diamond Tread, Single Latch



Part No.	Height	Depth	Width	# Latches per Door	Wt. (lb)	Cat.
1701551	16	13	72	1	78	530 (Y)
1701556	16	13	88	1	89	530 (Y)
1701563*	18	16	72	1	82	530 (Y)
1701564*	18	16	88	1	92	530 (Y)
1701565	18	16	90	1	99	530 (Y)

Aluminum Topsider

Diamond Tread, Dual Latch

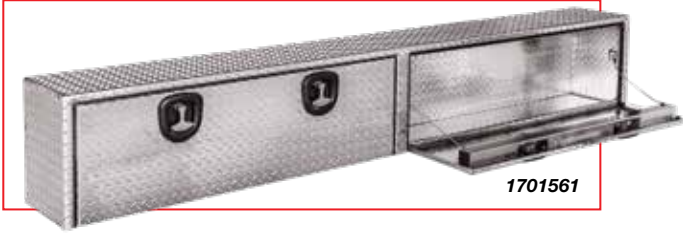

Part No.	Height	Depth	Width	# Latches per Door	Wt. (lb)	Cat.
1701561	16	13	96	2	92	530 (Y)
1701568	18	16	96	2	103	530 (Y)

Black Diamond Tread, Single Latch



Part No.	Height	Depth	Width	# Latches per Door	Wt. (lb)	Cat.
1721551	16	13	72	1	78	530 (Y)
1721556	16	13	88	1	89	530 (Y)
1721563*	18	16	72	1	82	530 (Y)
1721564*	18	16	88	1	92	530 (Y)
1721565	18	16	90	1	99	530 (Y)

Black Diamond Tread, Dual Latch



Part No.	Height	Depth	Width	# Latches per Door	Wt. (lb)	Cat.
1721561	16	13	96	2	92	530 (Y)
1721568	18	16	96	2	103	530 (Y)

Textured Matte Black Diamond Tread, Single Latch



Part No.	Height	Depth	Width	# Latches per Door	Wt. (lb)	Cat.
1722551	16	13	72	1	78	530 (Y)
1722556*	16	13	88	1	89	530 (Y)
1722563*	18	16	72	1	82	530 (Y)
1722564*	18	16	88	1	92	530 (Y)
1722565*	18	16	90	1	90	530 (Y)

Textured Matte Black Diamond Tread, Dual Latch



Part No.	Height	Depth	Width	# Latches per Door	Wt. (lb)	Cat.
1722561*	16	13	96	2	92	530 (Y)
1722568	18	16	96	2	103	530 (Y)

Aluminum Topsider

SMOOTH ALUMINUM DROP DOOR WITH COMPRESSION LATCH

- .100" thick smooth aluminum
- Locking die-cast T-handle compression latch
- Full length stainless steel bolt-on continuous hidden hinge
- Replaceable gasket sealing system
- Aircraft grade door cables
- Includes J-hooks for drill-free mounting and protective side rail pads
- Door opening: flat surface mount (90°)

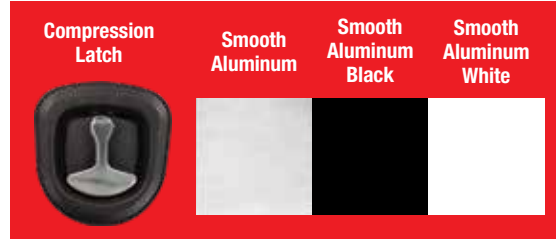

Smooth Aluminum, Single Latch



Part No.	Height	Depth	Width	# Latches per Door	Wt. (lb)	Cat.
1751651	16	13	72	1	78	530 (Y)
1751656	16	13	88	1	89	530 (Y)
1751663	18	16	72	1	93	530 (Y)
1751664	18	16	88	1	96	530 (Y)
1751665	18	16	90	1	99	530 (Y)

Smooth Aluminum, Dual Latch



Part No.	Height	Depth	Width	# Latches per Door	Wt. (lb)	Cat.
1751661	16	13	96	2	92	530 (Y)
1751668	18	16	96	2	103	530 (Y)

Smooth Aluminum, Single Latch, Black



Part No.	Height	Depth	Width	# Latches per Door	Wt. (lb)	Cat.
1752151	16	13	72	1	78	530 (Y)
1752156	16	13	88	1	89	530 (Y)
1752163	18	16	72	1	93	530 (Y)
1752164	18	16	88	1	96	530 (Y)
1752165	18	16	90	1	99	530 (Y)

Smooth Aluminum, Dual Latch, Black



Part No.	Height	Depth	Width	# Latches per Door	Wt. (lb)	Cat.
1752161	16	13	96	2	92	530 (Y)
1752168	18	16	96	2	103	530 (Y)

Aluminum Topsider

Smooth Aluminum, Single Latch, White



Part No.	Height	Depth	Width	# Latches per Door	Wt. (lb)	Cat.
1753151	16	13	72	1	78	530 (Y)
1753156	16	13	88	1	89	530 (Y)
1753163	18	16	72	1	93	530 (Y)
1753164	18	16	88	1	96	530 (Y)
1753165	18	16	90	1	99	530 (Y)

Smooth Aluminum, Dual Latch, White



Part No.	Height	Depth	Width	# Latches per Door	Wt. (lb)	Cat.
1753161	16	13	96	2	92	530 (Y)
1753168	18	16	96	2	103	530 (Y)



Aluminum Topsider

CONTRACTOR WITH LOWER COMPARTMENT

- .056" thick diamond tread aluminum
- Gas shocks lift and open door at over 90 degree angle
- Comes with two doors: top flip-up door and bottom drop door
- Locking stainless steel T-handle latches
- Replaceable gasket sealing system
- Aircraft grade door cables
- Mounting hardware included



1705640 open

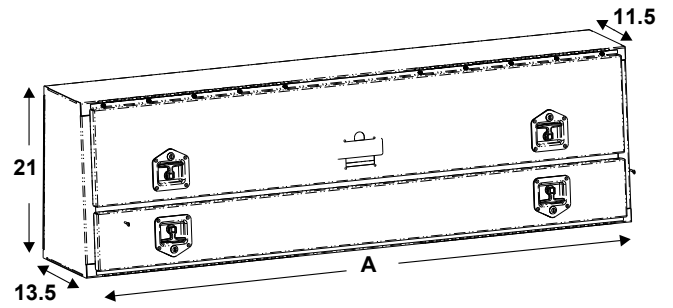

Diamond Tread



1705640

Part No.	Top Doors	Bottom Doors	Height	Depth	Width (A)	Wt. (lb)	Cat.
1705640	1	1	21	13.5/11.5	72	68.5	530 (Y)
1705650	1	1	21	13.5/11.5	88	83.5	530 (Y)
1705660	1	1	21	13.5/11.5	96	88.5	530 (Y)

Depth indicates bottom/top O.D.

Black Diamond Tread



1725640

Part No.	Top Doors	Bottom Doors	Height	Depth	Width (A)	Wt. (lb)	Cat.
1725640	1	1	21	13.5/11.5	72	68.5	530 (Y)
1725650	1	1	21	13.5/11.5	88	83.5	530 (Y)
1725660	1	1	21	13.5/11.5	96	88.5	530 (Y)

Depth indicates bottom/top O.D.

CONTRACTOR WITH TWO LOWER DRAWERS

- .056" thick diamond tread aluminum
- Gas shocks lift and open door at over 90 degree angle
- Locking stainless steel T-handle latches
- Replaceable gasket sealing system
- Bottom drawers come with adjustable dividers and 100 lb rated 12" slides
- Mounting legs and hardware included

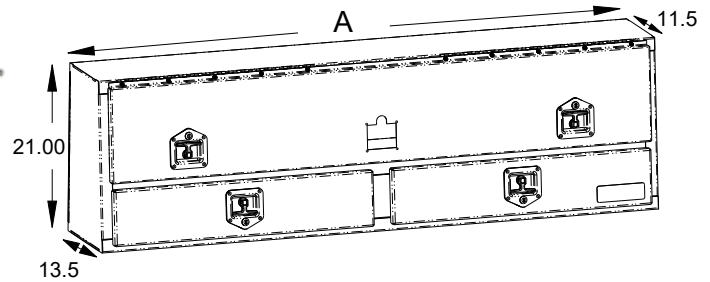

Diamond Tread



Part No.	Top Doors	Bottom Drawers	Height	Depth	Width (A)	Wt. (lb)	Cat.
1705641	1	2	21	13.5/11.5	72	58	530 (Y)
1705651	1	2	21	13.5/11.5	88	530 (Y)	

Depth indicates bottom/top O.D.

Black Diamond Tread



Part No.	Top Doors	Bottom Drawers	Height	Depth	Width (A)	Wt. (lb)	Cat.
1725641	1	2	21	13.5/11.5	72	58	530 (Y)
1725651	1	2	21	13.5/11.5	88	91	530 (Y)

Depth indicates bottom/top O.D.



BAC

Choose a style ...

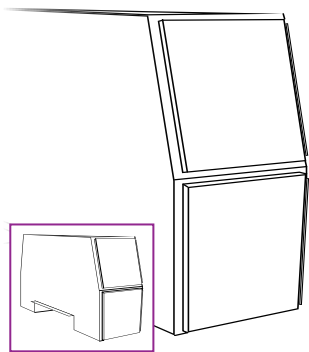

4 DOORS, SLANTED DOOR

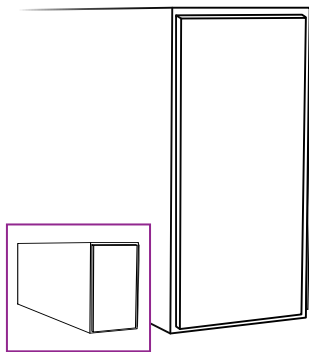

2 DOORS, STRAIGHT SIDES

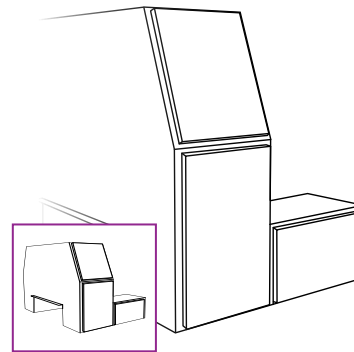

L-PACK

Choose a floor ...

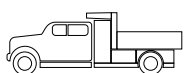
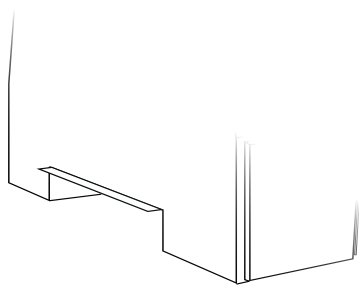

OFFSET FLOOR
(for conventional cabs)

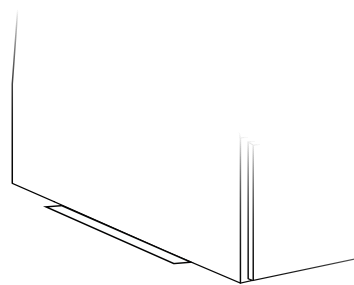

FLAT FLOOR
(for cab-over trucks)

Choose a material ...



DIAMOND TREAD
ALUMINUM



CARBON STEEL
BLACK

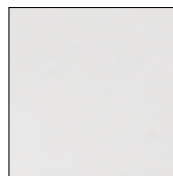

CARBON STEEL
WHITE

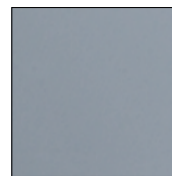

CARBON STEEL
PRIMED

СКРАС

4 Doors, Offset Floor

DIAMOND TREAD ALUMINUM



- .100" thick aluminum diamond tread
- Universal spring cushion mounting kit, included with all aluminum backpack boxes, provides flex to reduce strain

CARBON STEEL



- 14 gauge steel box with 12 gauge steel doors
- Optional U-Bolt mounting kit sold separately (see page 58)

Common Features



Manufactured by a talented workforce in Northeast Ohio



Backpack mounting adapter recommended for all 2017+ Ford® applications (see page 58 for details)



Stainless steel bolt-on continuous hidden hinges

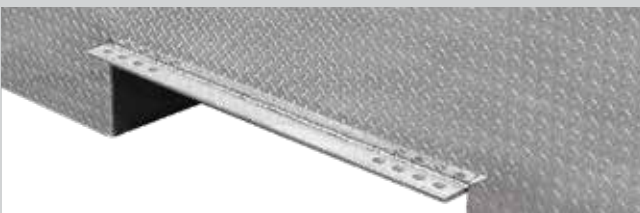

Integral mounting rail for quick and easy installation



Doors open easily with gas powered shocks plus built-in rain gutter with automotive bulb seal



Two shelves to organize tools and equipment plus two folding passenger side J-hooks

4 Doors, Offset Floor

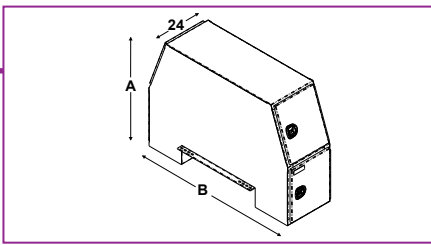

Diamond Tread Aluminum

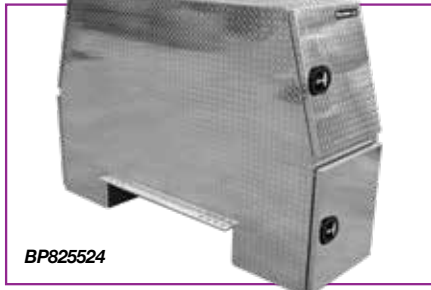

****CAUTION:** Failure to use supplied mounting kit may void warranty on Aluminum Backpack Boxes

Compression Latch	Diamond Tread	Spring Cushion Mounting Kit**

Part No.	Total Height (A)	Depth	Width (B)	Wt. (lb)	Cat.
BP825524	55	24	82	234	592 (Y)
BP826224	62	24	82	254	592 (Y)
BP826524	65	24	82	316	592 (Y)
BP827024	70	24	82	316	592 (Y)
BP925824	58	24	92	255	592 (Y)

For optional underbody box, see pages 54-55.

Steel, Black Powder-Coated



T-Handle Latch	Black	White	Primed

Part No.	Total Height (A)	Depth	Width (B)	Wt. (lb)	Cat.
BP855524B	55	24	85	536	592 (Y)
BP826524B	65	24	82	600	592 (Y)
BP925824B	58	24	92	576	592 (Y)

For optional underbody box, see pages 54-55.

Steel, White Powder-Coated



Part No.	Total Height (A)	Depth	Width (B)	Wt. (lb)	Cat.
BP855524W	55	24	85	538	592 (Y)
BP826524W	65	24	82	600	592 (Y)
BP925824W	58	24	92	576	592 (Y)

For optional underbody box, see pages 54-55.

Steel, Primed Powder-Coated



Part No.	Total Height (A)	Depth	Width (B)	Wt. (lb)	Cat.
BP855524P	55	24	85	538	592 (Y)
BP826524P	65	24	82	538	592 (Y)
BP925824P	58	24	92	576	592 (Y)

For optional underbody box, see pages 54-55.

4 Doors, Flat Floor

DIAMOND TREAD ALUMINUM



- .100" thick aluminum diamond tread
- Universal spring cushion mounting kit, included with all aluminum backpack boxes, provides flex to reduce strain

CARBON STEEL



- 14 gauge steel box with 12 gauge steel doors
- Optional U-Bolt mounting kit sold separately (see page 58)

Common Features



Manufactured by a talented workforce in Northeast Ohio

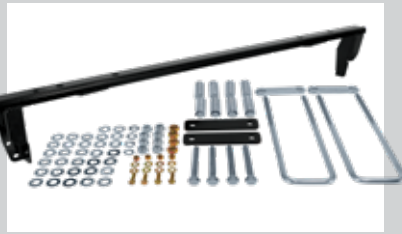

Backpack mounting adapter recommended for all 2017+ Ford® applications (see page 58 for details)



Stainless steel bolt-on continuous hidden hinges



Two shelves to organize tools and equipment plus two folding passenger side J-hooks



Integral mounting rail for quick and easy installation



Doors open easily with gas powered shocks plus built-in rain gutter with automotive bulb seal

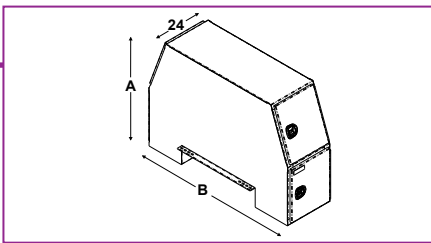

Diamond Tread Aluminum



****CAUTION:** Failure to use supplied mounting kit may void warranty on Aluminum Backpack Boxes

Compression Latch	Diamond Tread	Spring Cushion Mounting Kit**

Part No.	Total Height (A)	Depth	Width (B)	Wt. (lb)	Cat.
BP824624	46	24	82	216	592 (Y)
BP855924	59	24	85	350	530 (Y)



Steel, Black Powder-Coated



Compression Latch	T-Handle Latch	Black	White	Primed

Part No.	Total Height (A)	Depth	Width (B)	Wt. (lb)	Cat.
BP824624B	46	24	82	454	592 (Y)
BP855924B	59	24	85	536	592 (Y)



Steel, White Powder-Coated



Part No.	Total Height (A)	Depth	Width (B)	Wt. (lb)	Cat.
BP824624W	46	24	81	454	592 (Y)
BP855924W	59	24	85	536	592 (Y)



Steel, Primed Powder-Coated



Part No.	Total Height (A)	Depth	Width (B)	Wt. (lb)	Cat.
BP824624P	46	24	81	454	592 (Y)
BP855924P	59	24	85	536	592 (Y)



2 Doors, Offset Floor

DIAMOND TREAD ALUMINUM



- .100" thick aluminum diamond tread
- Universal spring cushion mounting kit, included with all aluminum backpack boxes, provides flex to reduce strain

CARBON STEEL



- 14 gauge steel box with 12 gauge steel doors
- Optional U-Bolt mounting kit sold separately (see page 58)

Common Features



Manufactured by a talented workforce in Northeast Ohio



Backpack mounting adapter recommended for all 2017+ Ford® applications (see page 58 for details)



Stainless steel bolt-on continuous hidden hinges

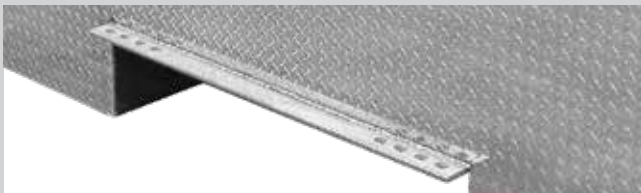

Integral mounting rail for quick and easy installation



Doors open easily with gas powered shocks plus built-in rain gutter with automotive bulb seal

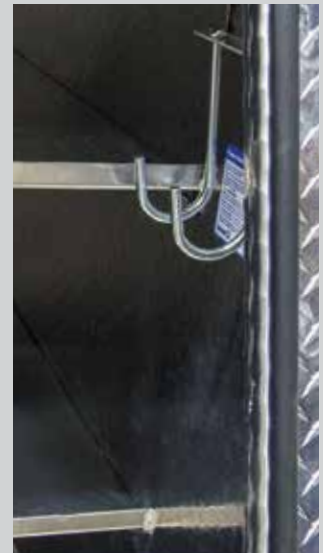

Two shelves to organize tools and equipment plus two folding passenger side J-hooks

Diamond Tread Aluminum



BP965724

****CAUTION:** Failure to use supplied mounting kit may void warranty on Aluminum Backpack Boxes

Part No.	Total Height	Depth	Width	Wt. (lb)	Cat.
BP965724	57	24	96	262	592 (Y)



Steel, Black Powder-Coated



BP965724B

Part No.	Total Height	Depth	Width	Wt. (lb)	Cat.
BP965724B	57	24	96	690	592 (Y)



Steel, White Powder-Coated



BP965724W

Part No.	Total Height	Depth	Width	Wt. (lb)	Cat.
BP965724W	57	24	96	690	592 (Y)



2 Doors, Flat Floor

DIAMOND TREAD ALUMINUM



- .100" thick aluminum diamond tread
- Universal spring cushion mounting kit, included with all aluminum backpack boxes, provides flex to reduce strain

CARBON STEEL



- 14 gauge steel box with 12 gauge steel doors
- Optional U-Bolt mounting kit sold separately (see page 58)

Common Features



Manufactured by a talented workforce in Northeast Ohio



Backpack mounting adapter recommended for all 2017+ Ford® applications (see page 58 for details)



Stainless steel bolt-on continuous hidden hinges

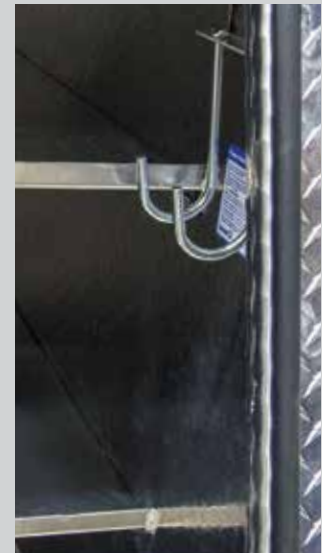

Two shelves to organize tools and equipment plus two folding passenger side J-hooks



Integral mounting rail for quick and easy installation



Doors open easily with gas powered shocks plus built-in rain gutter with automotive bulb seal

Diamond Tread Aluminum



BP964824

****CAUTION:** Failure to use supplied mounting kit may void warranty on Aluminum Backpack Boxes



Part No.	Total Height	Depth	Width	Wt. (lb)	Cat.
BP964824	48	24	96	240	592 (Y)



Steel, Black Powder-Coated



BP964824B



Part No.	Total Height	Depth	Width	Wt. (lb)	Cat.
BP964824B	48	24	96	700	592 (Y)
BP964824BLL	48	24	96	700	592 (Y)

BP964824BLL comes with 2 full length adjustable shelves



Steel, White Powder-Coated



BP964824W

Part No.	Total Height	Depth	Width	Wt. (lb)	Cat.
BP964824W	48	24	96	700	592 (Y)
BP964824WLL	48	24	96	700	592 (Y)

BP964824WLL comes with 2 full length adjustable shelves



Steel, Primed Powder-Coated



BP964824P

Part No.	Total Height	Depth	Width	Wt. (lb)	Cat.
BP964824P	48	24	96	700	592 (Y)



L-Pack

DIAMOND TREAD ALUMINUM

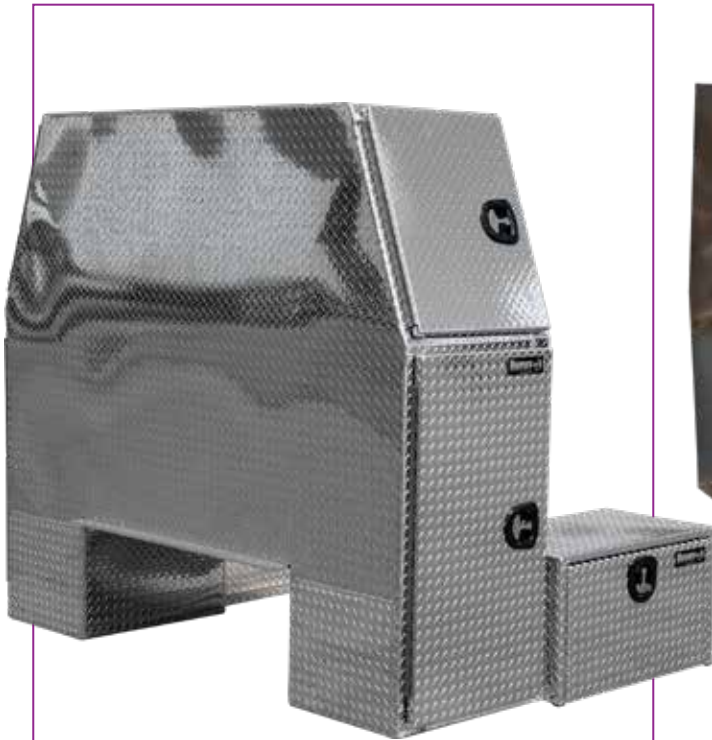

- .100" thick aluminum diamond tread
- Ships with 2 additional 30" underbody boxes welded on to provide additional storage
- Universal spring cushion mounting kit, included with all aluminum backpack boxes, provides flex to reduce strain

CARBON STEEL



- Tough 14 gauge steel body and 12 gauge steel doors with a corrosion resistant powder-coated finish
- Ships with 2 additional 24" underbody boxes bolted on to provide additional storage
- Optional U-Bolt mounting kit sold separately (see page 58)

Common Features



Manufactured by a talented workforce in Northeast Ohio

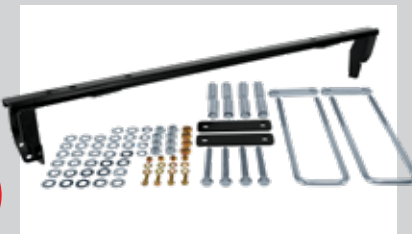

Backpack mounting adapter recommended for all 2017+ Ford® applications (see page 58 for details)



Stainless steel bolt-on continuous hidden hinges

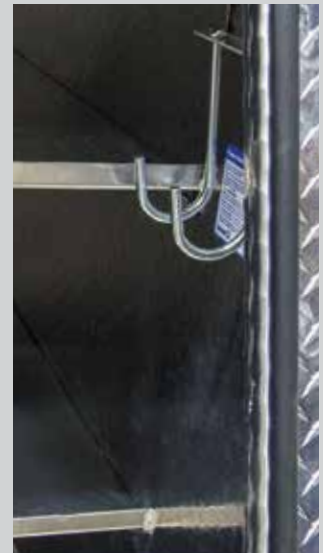

Two shelves to organize tools and equipment plus two folding passenger side J-hooks

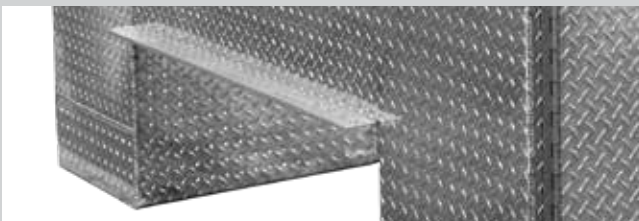

Integral mounting rail for quick and easy installation



Doors open easily with gas powered shocks plus built-in rain gutter with automotive bulb seal

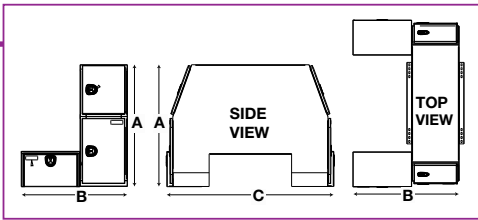

Diamond Tread Aluminum

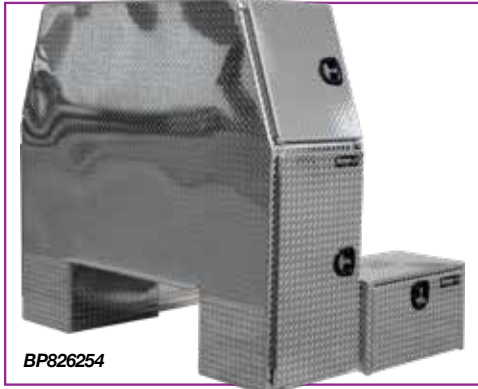

Part No.	Total Height (A)	Depth (C)	Width (B)	Wt. (lb)	Cat.
BP826254	62	54	82	340	592 (Y)
BP827054	70	54	82	384	592 (Y)

****CAUTION:** Failure to use supplied mounting kit may void warranty on Aluminum Backpack Boxes

Steel, Black Powder-Coated



Part No.	Total Height (A)	Depth (C)	Width (B)	Wt. (lb)	Cat.
BP855548B	55	54	82	638	592 (Y)

Steel, White Powder-Coated



Part No.	Total Height (A)	Depth (C)	Width (B)	Wt. (lb)	Cat.
BP855548W	55	54	82	638	592 (Y)

Underbody Boxes

DIAMOND TREAD ALUMINUM



- Can be used as bolt-on or weld-on underbodies with any backpack box
- Durable, corrosion-resistant, .100" thick aluminum diamond tread
- Locking die-cast T-handle compression latch

CARBON STEEL



- Can be used as bolt-on underbodies with any backpack box
- 14 gauge powder-coated steel box with 12 gauge steel door
- Locking stainless steel T-handle latch

Common Features



Manufactured by a talented workforce in Northeast Ohio



Drop-down recessed door



Aluminum bolt-on continuous hidden hinge and replaceable gasket sealing system

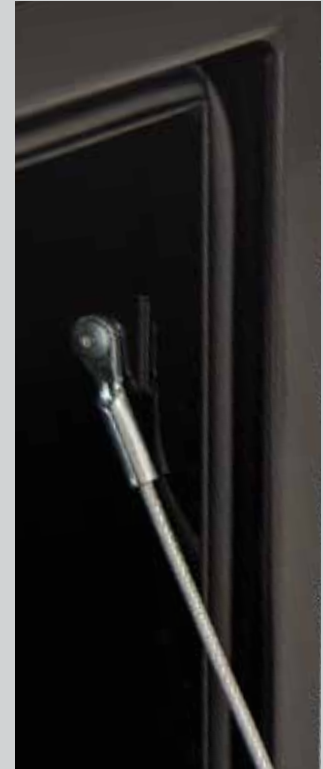

Aircraft grade door cables

Diamond Tread Aluminum



BP141624

Part No.	Total Height	Depth	Width	Wt. (lb)	Cat.
BP141624	14	16	24	18	530

Steel, Black Powder-Coated



1703300

Part No.	Total Height	Depth	Width	Wt. (lb)	Cat.
1703300	14	16	25	46	530
1703303	14	16	30	55	530
1703304*	14	16	30	72	530

*Includes built-in shelf

Steel, White Powder-Coated



1703400

Part No.	Total Height	Depth	Width	Wt. (lb)	Cat.
1703400	14	16	24	46	530
1703403	14	16	30	55	530
1703404*	14	16	30	72	530

*Includes built-in shelf

Steel, Primed Powder-Coated



1703900

Part No.	Total Height	Depth	Width	Wt. (lb)	Cat.
1703900	14	16	24	46	530

Accessories

STEEL AND ALUMINUM BACKPACK ACCESSORIES



Universal Spring Cushion Mounting Kit

- Provides flex to reduce strain on steel and aluminum backpack truck boxes
- Ideal for off-road applications
- 5/8" U-bolts with forged tie bars, springs and fasteners (all zinc plated)
- Included with all aluminum backpacks
- ⚠ **CAUTION:** Failure to use supplied mounting kit may void warranty on aluminum backpack boxes
- Additional sizes available as custom orders

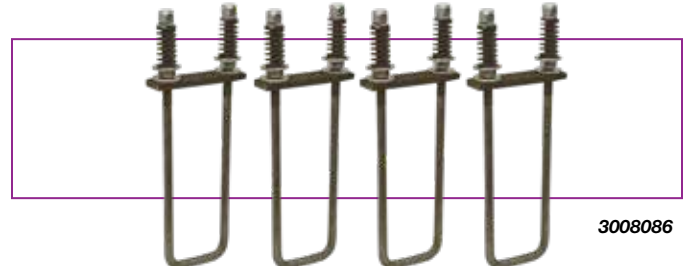

3008086

Part No.	Description	Wt. (lb)	Cat.
3008086	Universal Spring Cushion Mounting Kit	17	531 (Y)

Universal Square Bend U-Bolt Kit

- Secure truck boxes to truck body, or connect body to truck chassis
- 5/8" U-Bolts with fasteners and forged tie bars
- Durable Grade 5 hardware
- Additional sizes available as custom orders

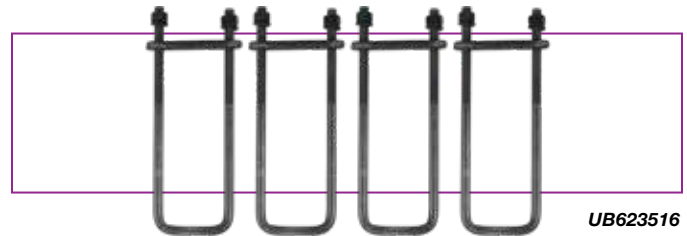

UB623516

Part No.	Description	Wt. (lb)	Cat.
UB623516	Universal Mounting Kit	17	531 (Y)

Backpack Mounting Adapter

- Provides a level base with a pre-fabricated kit that ensures optimal fit and reduced installation time
- Black powder-coated bracket and zinc plated hardware add corrosion resistance
- Recommended for use with all Ford® 2017+ applications

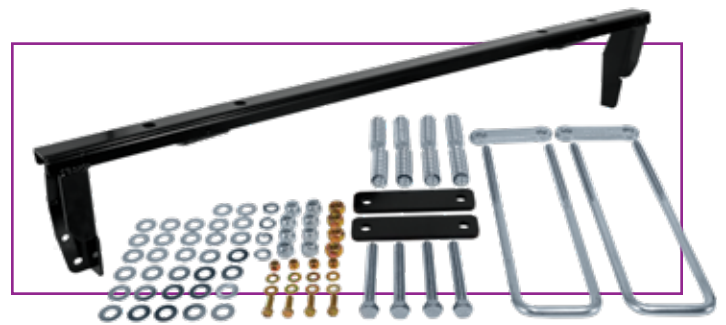

Part No.	Description	Wt. (lb)	Cat.
3037014	For Ford F350, F450, F550 (2017 - Mid 2020)	47.24	531 (Y)
3037014A	For Ford F350, F450, F550 (2020+)	46.96	531 (Y)

J-Hook Hanger

- Universal J-hook hangers for holding items like chains or straps
- Bolt-on or weld-on
- Folding zinc plated J-hooks swing flush with compartment walls when not in use
- Hanger 3009122 comes installed inside every box*



*Excludes BP964824BLL and BP964824WLL due to full-length shelving.

Part No.	Description	Wt. (lb)	Cat.
3009122	Double J-Hook with Steel Mounting Angle	0.85	530-1 (N)
3009938	Triple J-Hook with Aluminum Mounting Angle	2.16	530-1 (N)

LED Strip Light with 3M[®]** Adhesive Back



- Flexible strip lights can be mounted nearly anywhere extra light is needed. Ideal for tool boxes, truck beds, storage boxes, and trunk areas
- Each strip has a blunt cut connection on both ends and can be cut to length every three LEDs
- IP67 rated for water and dust resistance and backed with a 5 year warranty
- Includes end caps and mounting clips
- Separate 17.5" mounting channel also available

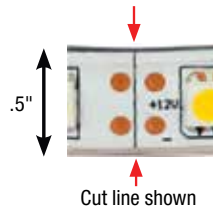

Part No.	Size	LED's	Amps	Lumens	Color	Connection	Std. Qty.	Wt. (lbs.)	Cat.
5621827	18"	27	0.41	360	Clear, Warm	Blunt Cut, Both Ends	1	0.31	562 (N)
5621928	18"	27	0.41	360	Clear, Cool	Blunt Cut, Both Ends	1	0.31	562 (N)
5622436	24"	36	0.54	470	Clear, Warm	Blunt Cut, Both Ends	1	0.35	562 (N)
5622537	24"	36	0.54	470	Clear, Cool	Blunt Cut, Both Ends	1	0.35	562 (N)
5622638*	24"	36	0.54	470	Red	Blunt Cut, Both Ends	1	0.35	562 (N)
5622739*	24"	36	0.54	470	Blue	Blunt Cut, Both Ends	1	0.35	562 (N)
5623654	36"	54	0.81	710	Clear, Warm	Blunt Cut, Both Ends	1	0.40	562 (N)
5623755	36"	54	0.81	710	Clear, Cool	Blunt Cut, Both Ends	1	0.40	562 (N)
5624872	48"	72	1.12	940	Clear, Warm	Blunt Cut, Both Ends	1	0.44	562 (N)
5624973	48"	72	1.12	940	Clear, Cool	Blunt Cut, Both Ends	1	0.44	562 (N)
5625074*	48"	72	1.12	940	Red	Blunt Cut, Both Ends	1	0.44	562 (N)
5625175*	48"	72	1.12	940	Blue	Blunt Cut, Both Ends	1	0.44	562 (N)
5626090	60"	90	1.30	1180	Clear, Warm	Blunt Cut, Both Ends	1	0.55	562 (N)
5626191	60"	90	1.30	1175	Clear, Cool	Blunt Cut, Both Ends	1	0.55	562 (N)
5626292*	60"	90	1.30	1175	Amber	Blunt Cut, Both Ends	1	0.55	562 (N)
56296144	96"	144	2.00	2160	Clear, Warm	Blunt Cut, Both Ends	1	0.88	562 (N)
56297145	96"	144	2.00	2160	Clear, Cool	Blunt Cut, Both Ends	1	0.88	562 (N)
56298146*	96"	144	2.00	1880	Amber	Blunt Cut, Both Ends	1	0.88	562 (N)
562109166	108"	165	3.00	2400	Clear, Cool	Blunt Cut, Both Ends	1	1.12	562 (N)
562133202	132"	201	4.00	3000	Clear, Cool	Blunt Cut, Both Ends	1	1.37	562 (N)

LED Strip Light Mounting Channel



Part No.	Length	Color	Mounting	Cat.
3035896	17-1/2"	Black	3M [®] ** Tape	562 (N)

**3M[®] is a registered trademark of 3M Company



IN-BED STORAGE



STORAGE

Crossover Truck Boxes

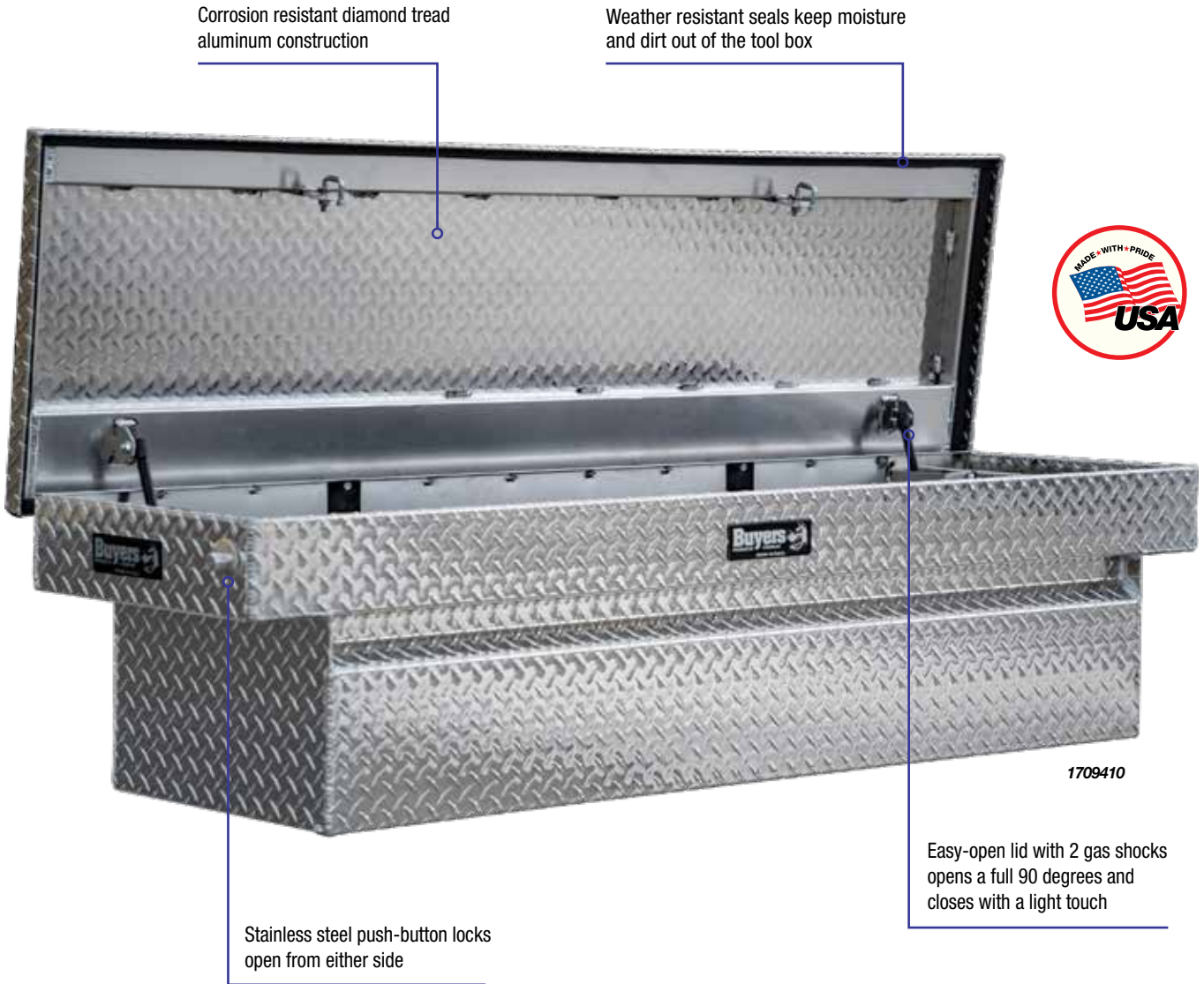

Corrosion resistant diamond tread aluminum construction

Weather resistant seals keep moisture and dirt out of the tool box



1709410

Stainless steel push-button locks open from either side

Easy-open lid with 2 gas shocks opens a full 90 degrees and closes with a light touch

Crossover Features

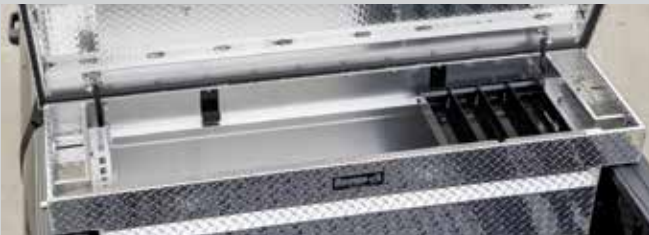

Lockable tray and integrated tool holders make it easy to stay organized



Stainless steel push-button locks



Fully concealed aluminum continuous hinge

SINGLE LID WITH PUSH-BUTTON LOCK

- Fits full size and compact pickup trucks
- Gas shock props lid open
- Stainless steel push-button locks open from either side
- Suspends from pickup side rails
- Includes mounting hardware
- Locking tool tray with removable dividers
- Pre-drilled mounting holes and included hardware make installation easy
- Available for full-size and compact pickups

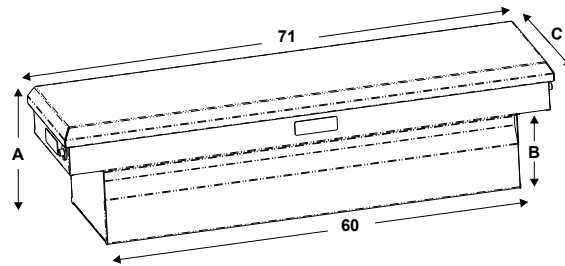
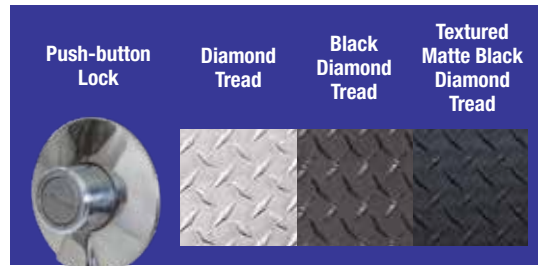

Diamond Tread



Part No.	Height (A/B)	Depth (C)	Width	Cubic ft.	Wt. (lb)	Cat.
1709410	18/11	20	71/60	11.1	75	530 (Y)
1709415	23/16	20	71/60	14.2	81	530 (Y)
1709420	18/11	27	71/60	15.1	89	530 (Y)
1709425**	23/16	27	71/60	19.1	94	530 (Y)
1709430	13/6	20	63/54	8.8	63	530 (Y)

Black Diamond Tread



Part No.	Height (A/B)	Depth (C)	Width	Cubic ft.	Wt. (lb)	Cat.
1729410	18/11	20	71/60	11.1	75	530 (Y)
1729415	23/16	20	71/60	14.2	77	530 (Y)
1729420	18/11	27	71/60	15.1	89	530 (Y)
1729425**	23/16	27	71/60	19.1	91	530 (Y)
1729430	13/6	20	63/54	8.8	63	530 (Y)

Textured Matte Black Diamond Tread



Part No.	Height (A/B)	Depth (C)	Width	Cubic ft.	Wt. (lb)	Cat.
1739410	18/11	20	71/60	11.1	75	530 (Y)
1739420	18/11	27	71/60	15	89	530 (Y)
1739415	23/16	20	71/60	14.2	81	530 (Y)
1739425**	23/16	27	71/60	19	94	530 (Y)
1739430	13/6	20	63/54	8.8	63	530 (Y)

**Works in beds with slants

Crossover

GULL WING WITH PUSH-BUTTON LOCK

- .100" thick diamond tread aluminum
- Double-sided lids with gas shocks
- Two stainless steel one-touch push-button locks
- Reinforced rib design
- Includes tray and dividers
- Suspends from pickup side rails with included J-Hooks
- Fits full size pickups with 6-1/2' and 8' beds
- Includes mounting hardware

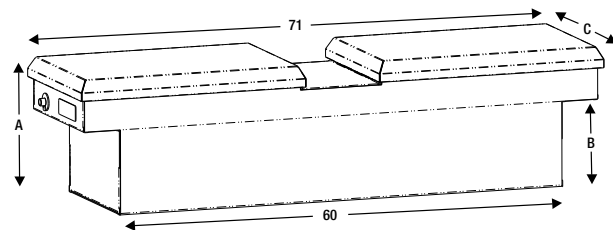
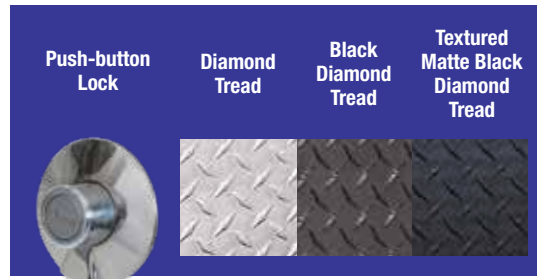

Diamond Tread



Part No.	Height (A/B)	Depth (C)	Width	Cubic ft.	Wt. (lb)	Cat.
1710305	18/11	20	71/60	11.1	67	530 (Y)
1710308	23/16	20	71/60	14.2	73	530 (Y)
1710315	18/11	27	71/60	15.1	81	530 (Y)
1710318*	23/16	27	71/60	19.1	85	530 (Y)

*Works in beds with slants

Black Diamond Tread



Part No.	Height (A/B)	Depth (C)	Width	Cubic ft.	Wt. (lb)	Cat.
1720305	18/11	20	71/60	11.1	67	530 (Y)
1720308	23/16	20	71/60	14.2	73	530 (Y)
1720315	18/11	27	71/60	15.1	81	530 (Y)
1720318*	23/16	27	71/60	19.1	85	530 (Y)

*Works in beds with slants

Textured Matte Black Diamond Tread



Part No.	Height (A/B)	Depth (C)	Width	Cubic ft.	Wt. (lb)	Cat.
1722305	18/11	20	71	11.1	67	530 (Y)

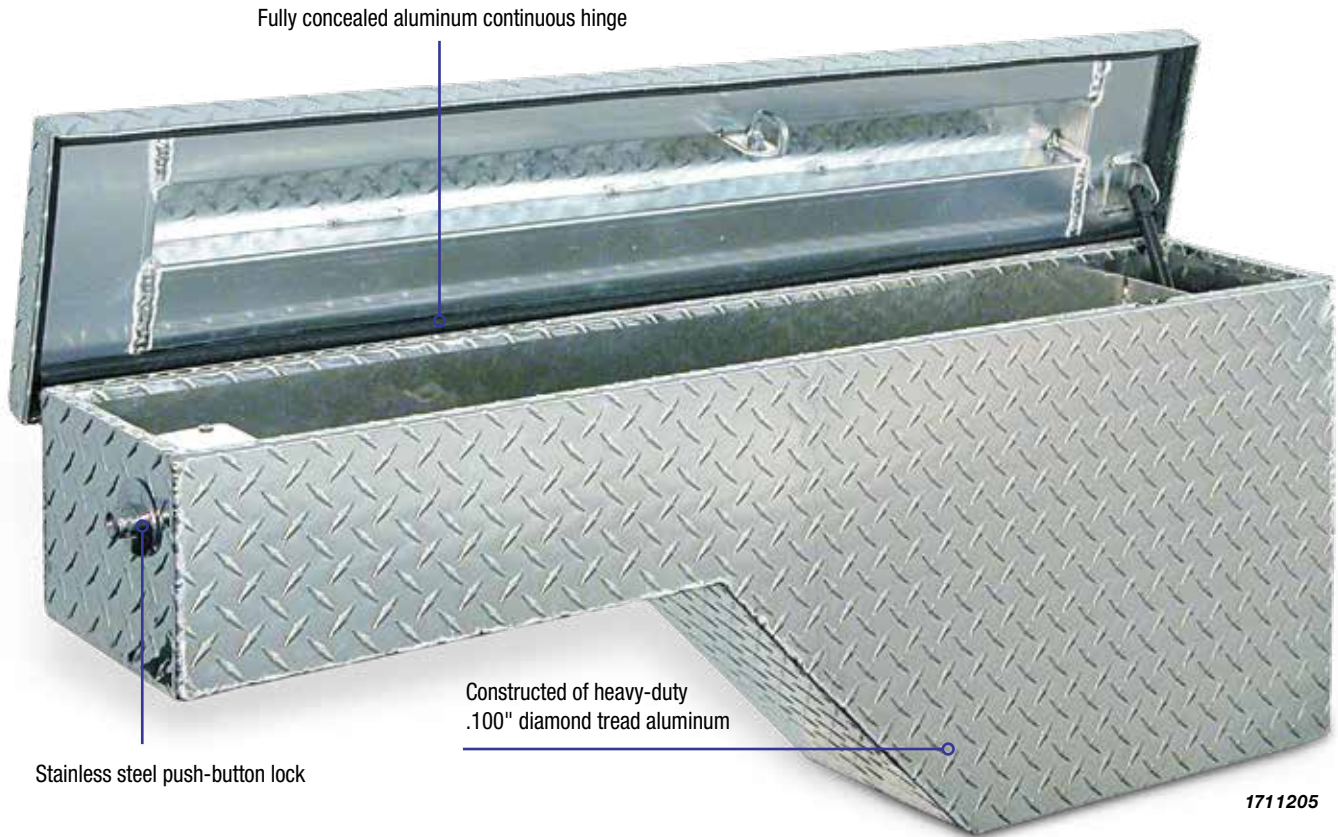

1711205

WHEEL WELL WITH PUSH-BUTTON LOCK

- .100" thick aluminum diamond tread aluminum
- Lid features gas shock and one-touch stainless steel push-button rotary locking mechanism
- Low profile over-the-wheel mounting offers convenient storage while maximizing pickup truck bed space
- Fits most pickups
- May also be mounted in front of wheel wells on full-size long bed pickups

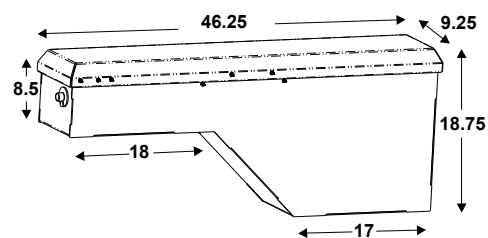
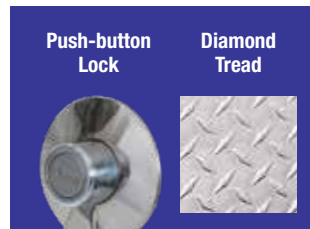

Diamond Tread



1711205

Part No.	Description	Height	Depth	Width	Wt. (lb)	Cat.
1711205	Driver Side Rear/	18.75/	9.25	46.25/	26	530
	Passenger Side Front	8.5				
1711206	Passenger Side Rear/	18.75/	9.25	46.25/	26	530
	Driver Side Front	8.5				

Lo-Sider Truck Boxes

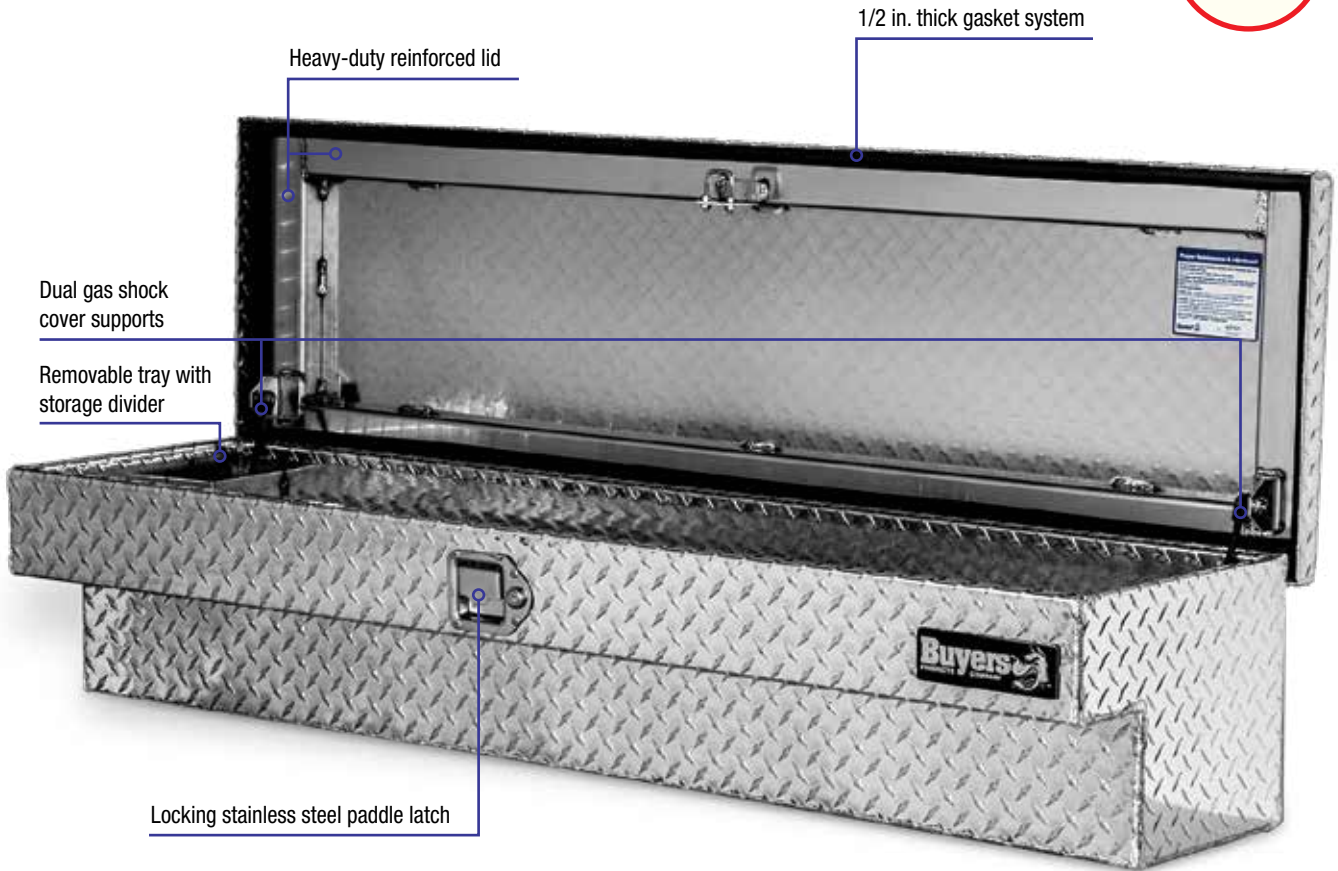

1711020

Lo-Sider/Rail Features



Removable tray with storage divider



The cover support housing protects the gas shocks



Locking stainless steel paddle latch



Full weather stripping keeps dust and moisture out

LO-SIDER WITH PADDLE LATCH

- .056" thick diamond tread
- Mounts along bed rail of pickups
- Locking stainless steel paddle latch
- Aluminum hinge is welded to the lid and bolted to the box
- Includes tray and dividers
- Mounting hardware included
- Fits full size pickups with 6-1/2' and 8' beds

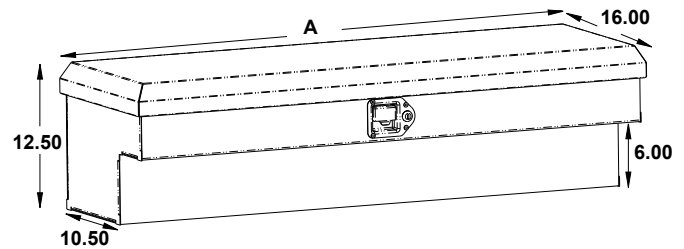

Diamond Tread



Part No.	Height	Depth	Width (A)	Cubic ft.	Wt. (lb)	Cat.
1711010	12.5	10.5	16	47	3.4	23 530 (Y)
1711020	12.5	10.5	16	56	4.0	47 530 (Y)
1711025	12.5	10.5	16	70	5.2	52 530 (Y)
1711030	12.5	10.5	16	87	6.3	63 530 (Y)

Black Diamond Tread



Part No.	Height	Depth	Width (A)	Cubic ft.	Wt. (lb)	Cat.
1721010	12.5	10.5	16	47	3.4	23 530 (Y)
1721020	12.5	10.5	16	56	4.0	47 530 (Y)
1721025	12.5	10.5	16	70	5.2	52 530 (Y)
1721030	12.5	10.5	16	87	6.3	63 530 (Y)

Textured Matte Black Diamond Tread



Part No.	Height	Depth	Width (A)	Cubic ft.	Wt. (lb)	Cat.
1731020	12.5	10.5	16	56	4.0	47 530 (Y)

Storage Chests

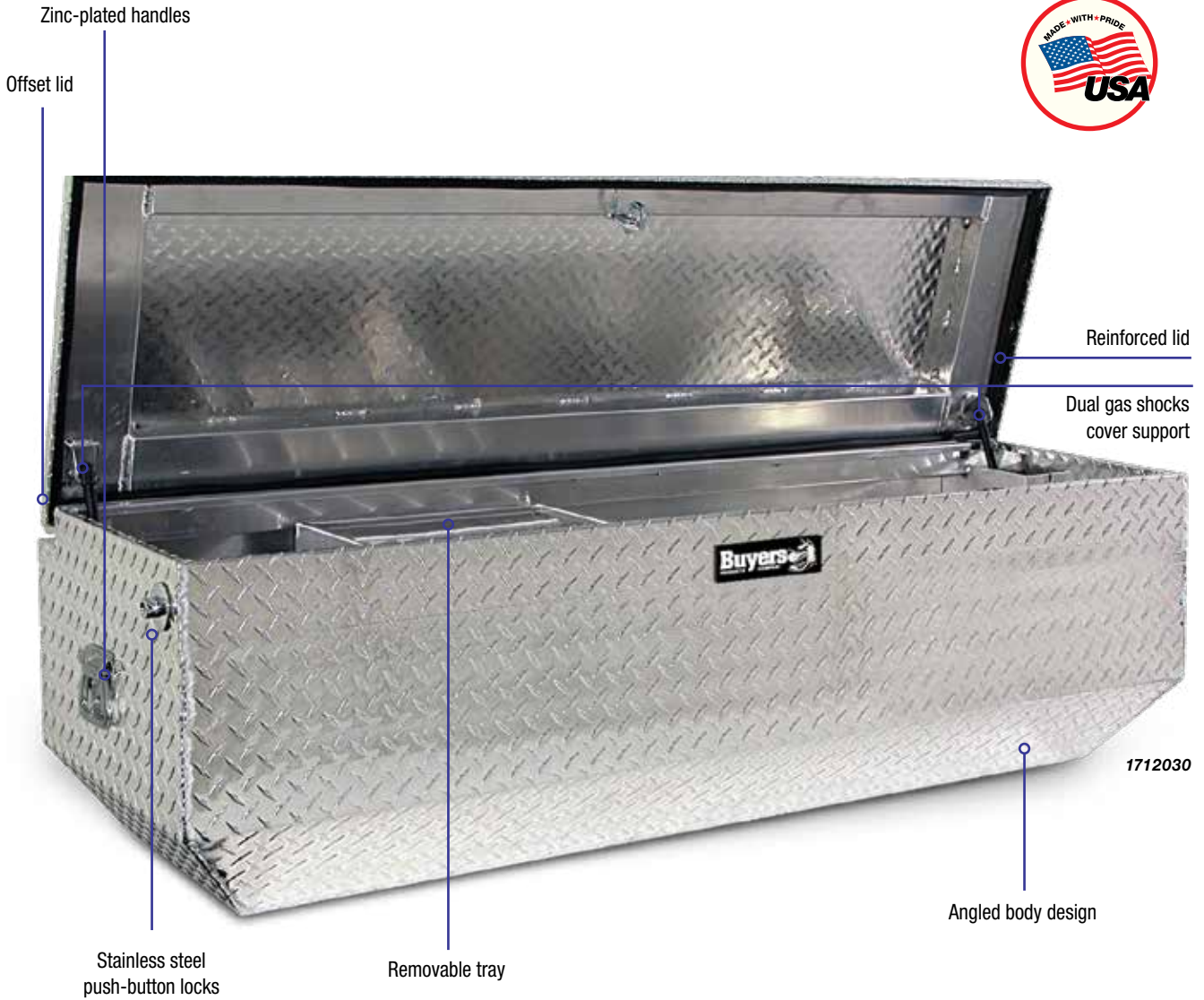

Storage Chest Features



Gas shock cover support protects shocks from damage.



Two zinc-plated handles for easy lifting.



Reinforced lid for extra durability.



Angled body design is ideal for use with fifth wheel and goose-neck trailer applications.

ANGLED BASE WITH PUSH-BUTTON LOCK

- .056" thick diamond tread
- Stainless steel one-touch push-button locks
- Continuous aluminum hinge is welded to the lid and bolted to the box
- Offset lid allows for 90° opening when placed against truck bed
- Door assisting gas shocks
- Angled body for use with fifth wheel or gooseneck trailer application
- Includes tray and dividers



Part No.	Height	Depth	Width (A/B)	Cubic ft.	Wt. (lb)	Cat.
1712010†	18.5	20/15	47/47	10	52.5	530 (Y)
1712020†	18.5	20/15	55/54	12	55	530 (Y)
1712030††	19	20/16	60/52	12.5	60	530 (Y)
1712035††	19	27/27	60/52	18	74	530 (Y)

†Boxes have angled base on front only

††Boxes have angled base on front and sides

Textured Matte Black



Part No.	Height	Depth	Width (A/B)	Cubic ft.	Wt. (lb)	Cat.
1722010†	18.5	20/15	47/47	10	52.5	530 (Y)

†Boxes have angled base on front only

JUMBO CHEST WITH PADDLE LATCH

- .100" thick diamond tread
- Locking stainless steel paddle latch
- Continuous aluminum hinge is welded to the lid and bolted to the box
- Zinc plated handles

Diamond Tread Aluminum



Part No.	Height	Depth	Width	Cubic ft.	Wt. (lb)	Cat.
1712110	24	24/22	49	15	73.5	530 (Y)
1712120	30	30/28	49	24	92	530 (Y)

Storage Chests

POLY CHEST WITH HASP

- Lightweight, dent-resistant, high-density polyethylene body
- Box contents stay safe and secure behind a molded, double-wall, stainless steel hinged lid
- Corrosion and weather resistant stainless steel hasp and hinge made for use with combination lock or padlock (lock sold separately)
- Mount to floor of pickup beds, trailers or for use in garages

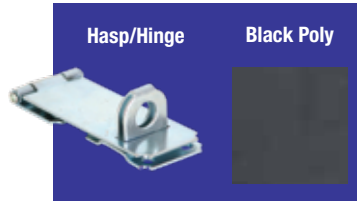

Black, Single Hasp



Part No.	# Hasps	Height	Depth	Width	Cubic ft.	Wt. (lb)	Cat.
1712230	1	13.5	15/9.25	32/29.5	2.6	16	530 (Y)
1712250	1	22.5	19.5/18.75	51/47	8.4	34	530 (Y)

Black, Dual Hasp



Part No.	# Hasps	Height	Depth	Width	Cubic ft.	Wt. (lb)	Cat.
1712240	2	17.25	19/13.25	44/41.25	6.3	28	530 (Y)
1712255	2	26	23/21	51/47.25	17	46	530 (Y)
1712260	2	23	25/19	77/73	18.8	52	530 (Y)

POLY CHEST WITH 2" RECEIVER MOUNT

- Durable, lightweight high density polyethylene construction
- Fully enclosed, water resistant design
- Mounts in 2" hitch receivers to provide portable, accessible storage
- Great for camping, fishing, tailgating, and more
- 17 cubic feet of functional space
- Holds up to 300 pounds
- Double walled lid with two lockable hasps (padlocks sold separately)
- Steel frame with black powder-coated finish
- Comes pre-drilled for easy assembly and installation
- Comes with all hardware including 5/8in. hitch pin



Part No.	# Hasps	Height	Depth	Width	Cubic ft.	Wt. (lb)	Cat.
1707020	2	26	23/21	51/47.25	17	76	530 (Y)



HEAVY DUTY POLY STORAGE BINS

- Constructed from durable and rust-proof polyethylene for years of use
- Double panel sloped lid provides a weather-resistant barrier to keep contents dry
- Molded hand holds and fork lift slots allow for easy lifting and carrying
- Ideal for storing dry, loose materials like rock salt, grain, sand, seed or litter
- Suitable for indoor or outdoor use

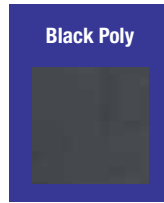

Black, 20" High



Part No.	Height	Depth	Width	Wt. (lb)	Cat.
9031105	20	24	36	21	903-1 (N)

SHIPS UPS!

Black, 30" High



Part No.	Height	Depth	Width	Wt. (lb)	Cat.
9031100	30	24	36	28	903-1 (N)

Material Scoop



Part No.	Height	Depth	Width	Wt. (lb)	Cat.
9031110	Material Scoop			2.47	903-1 (N)



Trailer Tongues



STEEL TRAILER TONGUE WITH HASP

- 14 gauge steel box with 12 gauge steel door
- Locking stainless steel paddle latch
- Stainless steel continuous hidden hinge
- Designed to mount to the front of A-frame style trailers

Black

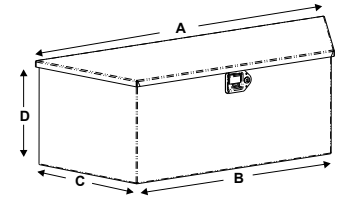
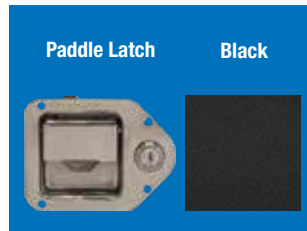

Part No.	Height (D)	Depth (C)	Width (A/B)	Wt. (lb)	Cat.
1701280	15	14.5	34/22.5	51	530 (Y)
1701281	12	13.25	26/14	33	530 (Y)
1701285	18.5	15	49/37	74	530 (Y)

ALUMINUM TRAILER TONGUE WITH PADDLE LATCH

- .056 thick diamond tread aluminum
- Locking stainless steel paddle latch
- Aluminum continuous hidden hinge
- Designed to mount to the front of A-frame style trailers

Diamond Tread

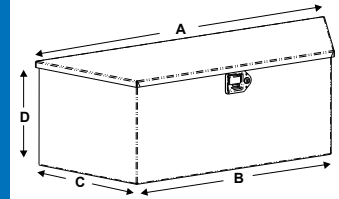

Part No.	Height (D)	Depth (C)	Width (A/B)	Wt. (lb)	Cat.
1701380	15	14.5	34/20.7	17.5	530 (Y)
1701385	18.5	15	49/37	28	530 (Y)

POLY TRAILER TONGUE WITH HASP

- Constructed of high-density polyethylene
- Designed to mount to the front of A-frame style trailers
- Corrosion and weather resistant stainless steel hasp and hinge made for use with combination lock or padlock (lock sold separately)

Black

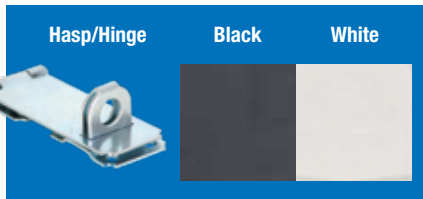
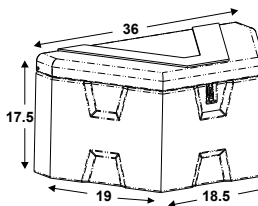

Part No.	Height	Depth	Width	Cubic ft.	Wt. (lb)	Cat.
1701680	18	19	36/ 8	5.34	21	530 (Y)

White



Part No.	Height	Depth	Width	Cubic ft.	Wt. (lb)	Cat.
1701679	18	19	36/18	5.34	21	530 (Y)

Class 8 Boxes



WideOpen™ Box Features



Die cast compression latch with covered key assembly



Non-slip (grip strut) steps and stainless steel continuous hidden hinge

WIDEOPEN™ STEP BOXES

- Provides frame steps with built-in storage space
- Universal design fits Peterbilt®, Kenworth®, International®, Freightliner®, Western-Star®, Volvo®, and Mack® trucks
- Non-slip (grip strut) steps
- .125" smooth aluminum construction
- D-bulb door seal protects from the elements
- Locking die-cast T-handle compression latch
- Stainless steel continuous hidden hinge
- Corner gussets on door opening provide extra strength
- 1/8" thick integral corner braces provide mounting support
- For heavy loads and toolboxes wider than 18", #1701015 steel mounting brackets are recommended to prevent stress cracks



Part No.	Height	Depth	Width	Wt. (lb)	Cat.
1705280	24	28	12	40	530 (Y)
1705281	24	28	18	47	530 (Y)
1705282	24	28	24	56	530 (Y)
1705283	24	28	30	64	530 (Y)
1705284	24	28	36	76	530 (Y)
1705285	24	28	16	45	530 (Y)
1705286	24	28	22	51	530 (Y)



Class 8 Boxes

STEP BOXES

- Provides frame steps with built-in storage space
- Non-slip (grip punch) steps
- .125" smooth aluminum body
- .100" diamond tread aluminum door
- D-bulb door seal protects from the elements
- Locking die-cast T-handle compression latch
- Stainless steel continuous hidden hinge
- Corner gussets on door opening provide extra strength
- 1/8" thick integral corner braces provide mounting support (for heavy loads and toolboxes wider than 18", #1701015 steel mounting brackets are recommended to prevent stress cracks)

Diamond Tread Aluminum



Part No.	Height	Depth	Width	Wt. (lb)	Cat.
1705180	24	28	12	40	530 (Y)
1705181	24	28	18	46	530 (Y)
1705182	24	28	24	56	530 (Y)
1705183	24	28	30	66	530 (Y)

FRAME STEPS

- Grip strut provides superior traction even in inclement weather
- Universal design fits Peterbilt®, Kenworth®, International®, Freightliner®, Western-Star®, Volvo®, and Mack® trucks
- Corrosion resistant aluminum construction with .188 in. thick sides for years of dependable service
- Universal 4-bolt mounting pattern is easy to install on most semi truck frames

Smooth Aluminum

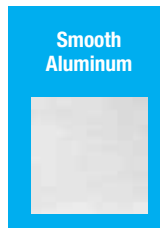

Part No.	Height	Depth	Width	Wt. (lb)	Cat.
5239012	24	28	12	12	523 (Y)
5239018	24	28	18	13	523 (Y)
5239024	24	28	24	14	523 (Y)

IN-FRAME BOXES

- Body constructed of .100" smooth aluminum
- .125" Diamond tread aluminum lid
- Full width stainless steel hinge
- Built-in rain gutter with automotive bulb seal
- Mounts between truck frame rails
- Adjustable stainless steel latch for use with combination lock or padlock (sold separately)
- Includes Mounting Kit
- Universal Mounting Kit (1705399) is also available separately for purchase

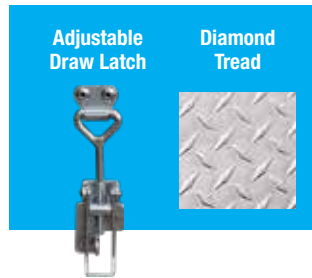

Diamond Tread Aluminum



Part No.	Height	Depth	Width	Wt. (lb)	Cat.
1705384*	9	22	30	42	530 (Y)
1705381*†	12	24	32	52	530 (Y)

†Includes notched center channel to accommodate driveline or accessories

CHAIN HOLDER

- Constructed of structural steel with aluminum diamond tread cover
- TIG welded
- Pre-drilled mounting holes
- Hinged diamond plate cover comes with lock hasp for secure use
- Keeps tire chains securely in place



Diamond Tread Aluminum



Part No.	Height	Depth	Width	Wt. (lb)	Cat.
5910024	9	7.5	24	34	591 (N)

Parts & Accessories

Die Cast Compression Latch



- Strong, secure compression operation
- Latch is secure and stays shut with the adjustable cam action roller engagement
- Helps keep dirt, grime, and dust out of your box
- Corrosion-resistant powder-coated housing
- Corrosion-resistant chrome plated T-handle
- Adjustable cam, from .850 in. to 1.320 in. (No tools required for adjustment)

***Replacement for Buyers boxes using L8816 and L3890RLS latch**

Part No.	Description	Wt. (lbs.)	Cat.
LL9000	Single Point, Compression Latch with Blind Studs, 1/2" Gasket and Cylinder with keys included	2.04	510 (N)
LL90003	3-Point, Compression Latch with Blind Studs, 1/2" Gasket and Cylinder with keys included	2.04	510 (N)

Heavy-Duty Standard Size Flush Mount Folding T-handle Latches



Part No.	Description	Wt. (lbs.)	Cat.
L882502	3/4" Replacement Rods for 2 and 3 point latches	105	510 (N)

- Polished Stainless steel
- Available in single, double or triple point contact to address most applications
- Adjustable cam from 1.25" to 2" to accommodate door thicknesses
- Designed to mount into a 3.75" x 4" recess opening.
(L8816 fits into 4.375" x 3.5" recess opening)

Part No.	Description	Wt. (lbs.)	Cat.
L8815	Stainless Steel T-Handle Latch with Mounting Holes, Cylinder & Keys Included	1.25	510 (N)
L8816	Tall Flush Mount T-Handle Latch with Blind Studs, Cylinder & Keys Included	1.50	510 (N)
L8915	Zinc Plated Stainless Steel T-Handle Latch with Mounting Holes, Cylinder & Keys Included	1.25	510 (N)
L8825	Standard Size 2 Point T-Handle Latch with Mounting Holes, Cylinder & Keys Included	2.50	510 (N)
L8835	Standard Size 3 Point T-Handle Latch with Mounting Holes, Cylinder & Keys Included	2.75	510 (N)
L8855	Standard Size Flush Mount T-Handle Latch with Blind Studs, Cylinder & Keys Included	1.26	510 (N)
L8815G0	Replacement Gasket For L8815, L8855, and L8915	0.01	510 (N)

Poly Underbody Replacement Latch

- Polished Stainless steel
- 3-Point latch
- Adjustable cam from 0.25" to 1.6"
- Designed to mount into a 4-3/8" x 3-1/2" recess opening

***Replacement for Buyers poly underbody boxes only, not compatible with standard underbody toolboxes**



Part No.	Description	Wt. (lbs.)	Cat.
L882502	3/4" Replacement Rods for 2 and 3 point latches	105	510 (N)

Part No.	Description	Wt. (lbs.)	Cat.
L8816R	3-Point Latch Folding-T Handle, with Roller	1.43	510 (N)

Mini Size Tear Drop Latch

- Ideal for use on toolboxes and other small compartment doors
- Polished stainless steel finish
- Locking version includes cylinder and two keys

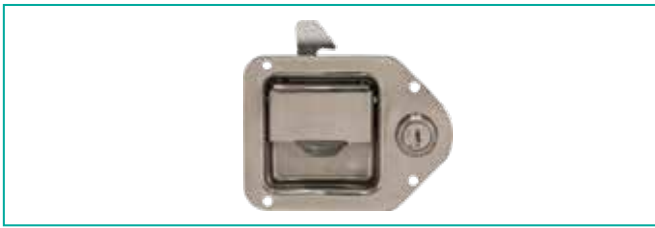

Part No.	Description	Face Dims. (HxW)	Wt. (lbs.)	Cat.
8000SSL	Stainless Steel Mini Size Tear Drop Style Latch (Locking)	4.38" x 3.25"	0.57	510 (N)
8000SSN	Stainless Steel Mini Size Tear Drop Style Latch (Non-Locking)	4.38" x 3.25"	0.55	510 (N)

Standard Size Single-Point Rotary Paddle Latch

- Polished stainless steel
- Hidden studs
- Includes gasket, cylinder and keys
- Includes hasp for alternative lock. Requires 7/16" diameter pad lock shank (not included)



Part No.	Description	Face Dims. (HxW)	Wt. (lbs.)	Cat.
L3890RLS	Stainless Steel Rotary Single Point Paddle Latch, 1/4" Striker	5.5" x 4.75"	1.40	510 (N)
3005833	Striker Plate/Bracket; for use with L3890RLS	-	0.26	530-1 (N)

Cylinder and Key

- For standard and mini size latches
- Various keys available



Part No.	Description	Wt. (lbs.)	Cat.
19CH545	Cylinder and Key	0.09	510 (N)
88CH510	Cylinder Lock with 2 Keys	0.13	510 (N)
39LL71	Cylinder and Key	0.09	510 (N)
L38RLSCH545	Cylinder for L3885RLS Latch	0.25	510 (N)
88CH545	Cylinder for L8815/L8915/L8816 Latch	0.25	510 (N)
CDC01Z	Zinc Die Cast Cylinder Dust Cover (Works with all Cylinders and Keys Listed Above)	0.05	510 (N)

Push Button Lock and Key

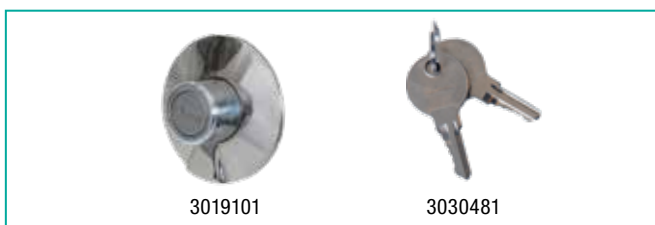

Part No.	Description	Wt. (lbs.)	Cat.
3019101	Push Button Lock with Key	0.68	530-1 (N)
3030481	Spare Keys for Push Button Lock	0.03	530-1 (N)

Parts & Accessories

Replacement Tray for 2020+ Crossover Truck Tool Boxes

- Oversized powder-coated steel tray with dividers
- 3 Dividers are removable for flexible storage
- For use with the newly redesigned cross body tool boxes (page 63)



Part No.	Depth (in)	Width (in)	Wt. (lbs.)	Cat.
3043331	15.375	18	7.64	530 (Y)
3047140	15.375	25	10.56	530 (Y)

Gas Shocks

- Dampened extension
- Undampened compression
- Black powder-coated cylinder



Part No.	Extended Length	Compressed Length	Stroke	Rod Diameter	Cylinder Diameter	Ball Socket Diameter	Force Rating (lbs.)	Wt. (lbs.)	Cat.
3010339	17"	10"	7"	6mm	15mm	10mm	20	0.42	530-1 (N)
3028786	13.93"	8.5"	5.5"	8mm	18mm	10mm	40	0.51	520 (N)
3045508	12"	8"	4"	6mm	15mm	10mm	40	0.27	530-1 (N)
3026586	12"	8"	4"	6mm	15mm	10mm	50	0.42	530-1 (N)
3029916	12"	8"	4"	6mm	15mm	10mm	60	0.27	530-1 (N)
3028392	12"	8"	4"	6mm	15mm	10mm	80	0.42	530-1 (N)
3029917	12"	8"	4"	9.65mm	18.13mm	10mm	100	0.38	530-1 (N)
3022729	12"	8"	4"	6mm	15mm	10mm	25	0.27	530-1 (N)
3023460	19.63"	11.63"	8"	9.98mm	21.59mm	10mm	250	0.85	903-2 (N)
3008745	10mm Ball Stud (Sold Separately except for 3028786)							0.03	530-1 (N)
FNE031018034	Nylock Nut for Ball Stud (Sold Separately except for 3023460)							0.01	530-1 (N)

Dry-Mat Tile

- 3/4" thick, tough automotive grade recycled plastic
- Provides fast evaporation while protecting the surface below
- Maintains original shape and color
- Fast, easy installation

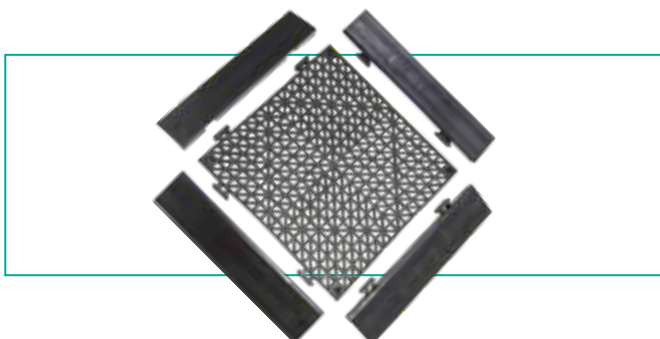

Part No.	Description	Dim	Wt. (lbs.)	Cat.
DM1212B	Tile	12" x 12"	1.42	880 (N)
DM0212BF	Female Edge	2" x 12"	0.33	880 (N)
DM0212BM	Male Edge	2" x 12"	0.35	880 (N)

Trailer Tongue Display Stand



- Works with all Buyers Products Trailer Tongue Tool Boxes
- Contact your Buyers Products sales representative for additional details
- Not intended for use as a retail selling shelf fixture



Part No.	Description	Cat.
3047012	Trailer Tongue Display Stand	994

Underbody Truck Tool Box Display Stand



- Works with all Buyers Products 18x18x36 Underbody Truck boxes
- Contact your Buyers Products sales representative for additional details
- Not intended for use as a retail selling shelf fixture

Part No.	Description	Cat.
99170	Underbody Truck Tool Box Display Stand	994

Underbody Replacement Parts

Part No.	Doors	Latches	Lanyards
1742300	1742300D00R	LL9000	3030806
1742303	1742303D00R	LL9000	3030806
1742305	1742305D00R	LL9000	3030806
1742310	1742310D00R	LL9000	3030806
1742315	1742303D00R	LL9000	3030806
1742325	1742305D00R	LL9000	3030806
1742335	1742335D00R	LL9000	3030806
1742336	1742310D00R	LL9000	3030806
1744300	1744300D00R	LL9000	3041851
1744303	1744303D00R	LL9000	3041851
1744305	1744305D00R	LL9000	3041851
1702295	1702295D00R	L8816	3003081
1702300	1702300D00R	L8816	3003081
1702303	1702303D00R	L8816	3003081
1702305	1702305D00R	L8816	3003081
1702310	1702310D00R	L8816	3003081
1702315	1702315D00R	L8816	3003081
1702317	1702317D00R	L8816	3003081
1702325	1702325D00R	L8816	3003081
1703300	1703300D00R	L8816	3003480
1703303	1703303D00R	L8816	3003480
1703305	1703305D00R	L8816	3003480
1703310	1703310D00R	L8816	3003480
1703312	1703312D00R	L8816	3003480
1703320	1703320D00R	L8816	3003480
1703322	1703322D00R	L8816	3003480
1703324	1703324D00R	L8816	3003480
1703326	1703326D00R	L8816	3003480
1703328	1703328D00R	L8816	3004556
1703330	1703330D00R	L8816	3003480
1703349	1703349D00R	L8816	3003480
1703350	1703350D00R	L8816	3003480
1703353	1703353D00R	L8816R	3003480
1704300	1704300D00R	L8816	3004713
1704303	1704303D00R	L8816	3004713
1704305	1704305D00R	L8816	3004713
1704310	1704310D00R	L8816	3004713
1704315	1704315D00R	L8816	3004713
1708310	1708310D00R	L8816	3003081
1702400	1702400D00R	L8816	3003081
1702403	1702403D00R	L8816	3003081
1702405	1702405D00R	L8816	3003081
1702410	1702410D00R	L8816	3003081
1702415	1702415D00R	L8816	3003081
1702417	1702417D00R	L8816	3003081
1702900	1702900D00R	L8816	3003081
1702905	1702905D00R	L8816	3003081
1702910	1702910D00R	L8816	3003081
1703400	1703400D00R	L8816	3003480
1703403	1703403D00R	L8816	3003480
1703405	1703405D00R	L8816	3003480
1703495	1703495D00R	L3890RLS	3003081
1703900	1703900D00R	L8816	3003480
1704400	1704400D00R	L8816	3004713
1704403	1704403D00R	L8816	3004713

Part No.	Doors	Latches	Lanyards
1704405	1704405D00R	L8816	3004713
1704410	1704410D00R	L8816	3004713
1704415	1704415D00R	L8816	3004713
1708410	1702410D00R	L8816	3003081
1703304	1703303D00R	L8816	3003480
1703351	1703349D00R	L8816	3003480
1703352	1703350D00R	L8816	3003480
1703355	1703303D00R	L8816	3003480
1703404	1703403D00R	L8816	3003480
1702100	1702100D00R	L3890RLS	3003081
1702103	1702103D00R	L3890RLS	3003081
1702105	1702105D00R	L3890RLS	3003081
1702110	1702110D00R	L3890RLS	3003081
1702115	1702115D00R	L3890RLS	3003081
1702200	1702200D00R	L3890RLS	3003081
1702203	1702203D00R	L3890RLS	3003081
1702205	1702205D00R	L3890RLS	3003081
1702210	1702210D00R	L3890RLS	3003081
1702215	1702215D00R	L3890RLS	3003081
1703100	1703100D00R	L3890RLS	3003480
1703103	1703103D00R	L3890RLS	3003480
1703150	1703150D00R	L3890RLS	3003480
1703203	1703203D00R	L3890RLS	3003480
1703205	1703205D00R	L3890RLS	3003480
1702406	-	LL90003	-
1702411	-	LL90003	-
1732300	1732300D00R	LL90003	3024237
1732303	1703203D00R	L3890RLS	3003480
1732305	1732305D00R	LL90003	3024237
1732310	1732310D00R	LL90003	3024237
1732315	-	LL90003	3003081
1732400	1732400D00R	LL90003	3024237
1732403	1732403D00R	LL90003	3024237
1732405	1732405D00R	LL90003	3024237
1732500	1732500D00R	LL90003	3024237
1732503	1732503D00R	LL90003	3024237
1732505	1732505D00R	LL90003	3024237
1732510	1732510D00R	LL90003	3024237
1734300	1734300D00R	LL90003	3024238
1734303	1734303D00R	LL90003	3024238
1734305	1734305D00R	LL90003	3024238
1734400	1734400D00R	LL90003	3024238
1734403	1734403D00R	LL90003	3024238
1734405	1734405D00R	LL90003	3024238
1734500	1734500D00R	LL90003	3024238
1734503	1734503D00R	LL90003	3024238
1734505	1734505D00R	LL90003	3024238
1702700	1702700D00R	LL9000	3003081
1702703	1702703D00R	LL9000	3003081
1702705	1702705D00R	LL9000	3003081
1702710	1702710D00R	LL9000	3003081
1702715	1702715D00R	LL9000	3003081
1702725	1702705D00R	LL9000	3003081
1703700	1703700D00R	LL9000	3003480
1703703	1703703D00R	LL9000	3003480

Part No.	Doors	Latches	Lanyards
1703705	1703705D00R	LL9000	3003480
1704705	1704705D00R	LL9000	3004713
1704710	1704710D00R	LL9000	3003081
1704715	1704715D00R	LL9000	3003081
1702595	1702595D00R	LL9000	3003081
1702600	1702600D00R	LL9000	3003081
1702603	1702603D00R	LL9000	3003081
1702605	1702605D00R	LL9000	3003081
1702610	1702610D00R	LL9000	3003081
1704600	3047158	LL9000	3004713
1704603	3047159	LL9000	3004713
1704610	3010773	LL9000	3004713
1704615	3047195	LL9000	3004713
1702650	1702650D00R	LL9000	-
1702653	1702653D00R	LL9000	-
1702655	1702655D00R	LL9000	-
1702660	1702660D00R	LL9000	-
1702500	1702500D00R	LL9000	3003081
1702503	1702503D00R	LL9000	3003081
1702505	1702505D00R	LL9000	3003081
1702510	1702510D00R	LL9000	3003081
1706400	1706400D00RB	LL90003	3033784
1706403	1706403D00RB	LL90003	3033784
1706405	1706405D00RB	LL90003	3033784
1706410	1706410D00RB	LL90003	3033784
1706415	1706415D00RB	LL90003	3033784
1706420	1706420D00RB	LL90003	3033784
1706425	1706425D00RB	LL90003	3033784
1706430	1706430D00RB	LL90003	3033784
1706960	-	LL90003	3033784
1706963	-	LL90003	3033784
1706965	-	LL90003	3033784
1706970	-	LL90003	3033784
1706975	-	LL90003	3033784
1706980	-	LL90003	3033784
1706985	-	LL90003	3033784
1706990	-	LL90003	3033784
1707960	-	LL90003	3033784
1707963	-	LL90003	3033784
1707965	-	LL90003	3033784
1707970	-	LL90003	3033784
1707975	-	LL90003	3033784
1707980	-	LL90003	3033784
1707985	-	LL90003	3033784
1707990	-	LL90003	3033784
1706500	1706500D00RB	LL90003	3033784
1706503	1706503D00RB	LL90003	3033784
1706505	1706505D00RB	LL90003	3033784
1706510	1706510D00RB	LL90003	3033784
1706515	1706515D00RB	LL90003	3033784
1706520	1706505D00RB	LL90003	3033784
1706525	1706510D00RB	LL90003	3033784
1706530	1706515D00RB	LL90003	3033784
1712200	-	LL9000	3003081
1712205	-	LL9000	3003081

Underbody Replacement Parts, continued

Part No.	Doors	Latches	Lanyards	Part No.	Doors	Latches	Lanyards	Part No.	Doors	Latches	Lanyards
1712210	-	LL9000	3003081	1705150	1705150D00RB	LL9000	3003480	1725133	1725133D00RB	LL9000	3004713
1705100	1705100D00RB	LL9000	3003081	1705153	1705153D00RB	LL9000	3003480	1725135	1725135D00R	LL9000	3004713
1705101	1705101D00RB	LL9000	3003081	1705160	1705160D00RB	LL9000	3003480	1725140	1725140D00R	LL9000	3004713
1705102	1705102D00RB	LL9000	3003081	1715100	1715100D00RB	LL9000	3003081	1725145	1725145D00RB	LL9000	3004713
1705103	1705103D00RB	LL9000	3003081	1715105	1715105D00RB	LL9000	3003081	1725147	1725147D00RB	LL9000	3004713
1705105	1705105D00RB	LL9000	3003081	1715110	1715110D00RB	LL9000	3003081	1725148	1725148D00RB	LL9000	3003480
1705110	1705110D00RB	LL9000	3003081	1715115	1715115D00RB	LL9000	3003081	1725149	1725149D00RB	LL9000	3003480
1705115	1705115D00RB	LL9000	3003081	1725100	1725100D00R	LL9000	3003081	1725150	1725150D00RB	LL9000	3003480
1705118	1705118D00RB	LL9000	3024237	1725101	1725101D00RB	LL9000	3003081	1725153	1725153D00RB	LL9000	3003081
1705119	-	LL9000	3003081	1725102	1725102D00RB	LL9000	3003081	1725160	1725160D00RB	LL9000	3003081
1705120	1705110D00RB	LL9000	3003081	1725103	1725103D00RB	LL9000	3003081	1735100	1735100D00R	LL90003	3003081
1705125	-	LL9000	3003081	1725105	1725105D00R	LL9000	3003081	1735103	1735103D00RB	LL90003	3003081
1705130	1705130D00RB	LL9000	3004713	1725110	1725110D00R	LL9000	3003081	1735105	1735105D00R	LL90003	3003081
1705133	1705133D00RB	LL9000	3004713	1725115	1725115D00RB	LL9000	3003081	1735130	1735130D00R	LL90003	3004713
1705135	1705135D00RB	LL9000	3004713	1725116	1725116D00RB	LL9000	3003081	1735133	1735133D00R	LL90003	3004713
1705140	1705140D00RB	LL9000	3004713	1725118	1725118D00RB	LL9000	3024237	1735135	1735135D00R	LL90003	3004713
1705145	1705145D00RB	LL9000	3004713	1725119	1725119D00RB	LL9000	3003081				
1705147	1705147D00RB	LL9000	3004713	1725120	1725120D00RB	LL9000	3003081				
1705148	1705148D00RB	LL9000	3003480	1725125	-	LL9000	3003081				
1705149	1705149D00RB	LL9000	3003480	1725130	1725130D00R	LL9000	3004713				

Barn Door Replacement Parts

PART NO.	DOORS WITH LATCH	DOOR WITHOUT LATCH	LATCHES	PART NO.	DOORS WITH LATCH	DOOR WITHOUT LATCH	LATCHES
1702225	1702225D00RBWLCH	1702225D00RBNLCH	LL9000	1705415	1705415D00RBWLCH	1705415D00RBNLCH	LL90003
1702230	1702230D00RBWLCH	1702230D00RBNLCH	LL9000	1705420	1705420D00RBWLCH	1705420D00RBNLCH	LL90003
1702235	1702235D00RBWLCH	1702235D00RBNLCH	LL90003	1705425	1705425D00RBWLCH	1705425D00RBNLCH	LL90003
1702240	1702240D00RBWLCH	1702240D00RBNLCH	LL90003	1705430	1705430D00RBWLCH	1705430D00RBNLCH	LL90003
1702250	1702250D00RBWLCH	1702250D00RBNLCH	LL90003	1705431	1705431D00RBWLCH	1705431D00RBNLCH	LL9000
1705200	1705200D00RBWLCH	1705200D00RBNLCH	LL90003	1705433	1705433D00RBWLCH	1705433D00RBNLCH	LL9003
1705201	1705201D00RBWLCH	1705201D00RBNLCH	LL90003	1705435	1705435D00RBWLCH	1705435D00RBNLCH	LL90003
1705203	1705203D00RBWLCH	1705203D00RBNLCH	LL90003	1705440	1705440D00RBWLCH	1705440D00RBNLCH	LL90003
1705205	1705205D00RBWLCH	1705205D00RBNLCH	LL90003	1705445	1705445D00RBWLCH	1705445D00RBNLCH	LL90003
1705210	1705210D00RBWLCH	1705210D00RBNLCH	LL90003	1705450	1705450D00RBWLCH	1705450D00RBNLCH	LL90003
1705215	1705215D00RBWLCH	1705215D00RBNLCH	LL90003	1705795	1705795D00RBWLCH	1705795D00RBNLCH	LL9000
1705295	1705295D00RBWLCH	1705295D00RBNLCH	LL9000	1705800	1705800D00RBWLCH	1705800D00RBNLCH	LL9000
1705300	1705300D00RBWLCH	1705300D00RBNLCH	LL9000	1705825	1705825D00RBWLCH	1705825D00RBNLCH	LL9000
1705303	1705303D00RBWLCH	1705303D00RBNLCH	LL90003	1705895	1705895D00RBWLCH	1705895D00RBNLCH	LL9000
1705305	1705305D00RBWLCH	1705305D00RBNLCH	LL90003	1705900	1705900D00RBWLCH	1705900D00RBNLCH	LL9000
1705310	1705310D00RBWLCH	1705310D00RBNLCH	LL90003	1705903	1705903D00RBWLCH	1705903D00RBNLCH	LL9003
1705315	1705315D00RBWLCH	1705315D00RBNLCH	LL90003	1705931	1705931D00RBWLCH	1705931D00RBNLCH	LL9000
1705333	1705333D00RBWLCH	1705333D00RBNLCH	LL90003	1705933	1705933D00RBWLCH	1705933D00RBNLCH	LL9000
1705335	1705335D00RBWLCH	1705335D00RBNLCH	LL90003	1706795	1706795D00RBWLCH	1706795D00RBNLCH	LL9000
1705395	1705395D00RBWLCH	1705395D00RBNLCH	LL9000	1706800	1706800D00RBWLCH	1706800D00RBNLCH	LL9000
1705340	1705340D00RBWLCH	1705340D00RBNLCH	LL90003	1706825	1706825D00RBWLCH	1706825D00RBNLCH	LL9000
1705345	1705345D00RBWLCH	1705345D00RBNLCH	LL90003	1706895	1706895D00RBWLCH	1706895D00RBNLCH	LL9000
1705350	1705350D00RBWLCH	1705350D00RBNLCH	LL90003	1706900	1706900D00RBWLCH	1706900D00RBNLCH	LL9000
1705401	1705401D00RBWLCH	1705401D00RBNLCH	LL9000	1706903	1706903D00RBWLCH	1706903D00RBNLCH	LL9003
1705403	1705403D00RBWLCH	1705403D00RBNLCH	LL9003	1706931	1706931D00RBWLCH	1706931D00RBNLCH	LL9000
1705405	1705405D00RBWLCH	1705405D00RBNLCH	LL90003	1706933	1706933D00RBWLCH	1706933D00RBNLCH	LL9003
1705410	1705410D00RBWLCH	1705410D00RBNLCH	LL90003				

PART NO.	PAGE NO.	PART NO.	PAGE NO.	PART NO.	PAGE NO.	PART NO.	PAGE NO.	PART NO.	PAGE NO.
19CH545.....	77	1702315.....	9	1703100.....	12	1705130.....	25	1705660.....	40
39LL71.....	77	1702317.....	9	1703103.....	12	1705133.....	25	1705795.....	28
88CH510.....	77	1702325.....	9	1703150.....	12	1705135.....	25	1705800.....	28
88CH545.....	77	1702400.....	10	1703203.....	12	1705140.....	25	1705803.....	28
8000SSL.....	77	1702403.....	10	1703205.....	12	1705145.....	25	1705805.....	28
8000SSN.....	77	1702405.....	10	1703300.....	9, 55	1705147.....	25	1705810.....	28
99170.....	79	1702406.....	11, 13	1703303.....	9, 55	1705148.....	25	1705815.....	28
1701000.....	31	1702410.....	10	1703304.....	11, 55	1705149.....	25	1705833.....	28
1701001.....	31	1702411.....	1, 13	1703305.....	9	1705150.....	25	1705835.....	28
1701005.....	30	1702415.....	10	1703310.....	9	1705153.....	25	1705840.....	28
1701005B.....	30	1702417.....	10	1703312.....	9	1705160.....	25	1705845.....	28
1701006.....	30	1702500.....	17	1703320.....	9	1705180.....	74	1705850.....	28
1701006B.....	30	1702503.....	17	1703322.....	9	1705181.....	74	1705895.....	20
1701010.....	30	1702505.....	17	1703324.....	9	1705182.....	74	1705900.....	20
1701010B.....	30	1702510.....	17	1703326.....	9	1705183.....	74	1705903.....	20
1701011.....	30	1702595.....	15	1703328.....	9	1705200.....	29	1705905.....	20
1701011B.....	30	1702600.....	15	1703330.....	9	1705201.....	29	1705910.....	20
1701012.....	30	1702603.....	15	1703349.....	9	1705203.....	29	1705915.....	20
1701015.....	30	1702605.....	15	1703350.....	9	1705205.....	29	1705920.....	20
1701016.....	30	1702610.....	15	1703351.....	11	1705210.....	29	1705925.....	20
1701030.....	31	1702650.....	16	1703352.....	11	1705215.....	29	1705930.....	20
1701031.....	31	1702653.....	16	1703353.....	9	1705280.....	73	1705931.....	20
1701040.....	31	1702655.....	16	1703355.....	11	1705281.....	73	1705933.....	20
1701041.....	31	1702660.....	16	1703400.....	10, 55	1705282.....	73	1705935.....	20
1701280.....	71	1702700.....	14	1703403.....	10, 55	1705283.....	73	1705940.....	20
1701281.....	71	1702703.....	14	1703404.....	11, 55	1705284.....	73	1705945.....	20
1701285.....	71	1702705.....	14	1703405.....	10	1705285.....	73	1705950.....	20
1701380.....	71	1702710.....	14	1703495.....	10	1705286.....	73	1706400.....	22
1701385.....	71	1702715.....	14	1703700.....	14	1705295.....	28	1706403.....	22
1701551.....	36	1702725.....	14	1703703.....	14	1705300.....	28	1706405.....	22
1701556.....	36	1702840.....	35	1703705.....	14	1705303.....	28	1706410.....	22
1701561.....	37	1702840TRAY.....	35	1703900.....	10, 55	1705305.....	28	1706415.....	22
1701563.....	36	1702850.....	35	1704300.....	9	1705310.....	28	1706420.....	22
1701564.....	36	1702850TRAY.....	35	1704303.....	9	1705315.....	28	1706425.....	22
1701565.....	36	1702860.....	35	1704305.....	9	1705325.....	28	1706430.....	22
1701568.....	37	1702860TRAY.....	35	1704310.....	9	1705333.....	28	1706500.....	23
1701679.....	71	1702880.....	35	1704315.....	9	1705335.....	28	1706503.....	23
1701680.....	71	1702880TRAY.....	35	1704400.....	10	1705340.....	28	1706505.....	23
1701768.....	36	1702890.....	35	1704403.....	10	1705345.....	28	1706510.....	23
1702100.....	12	1702890TRAY.....	35	1704405.....	10	1705350.....	28	1706515.....	23
1702103.....	12	1702895.....	35	1704410.....	10	1705381.....	75	1706520.....	23
1702105.....	12	1702895TRAY.....	35	1704415.....	10	1705384.....	75	1706525.....	23
1702110.....	12	1702900.....	10	1704600.....	15	1705395.....	20	1706530.....	23
1702115.....	12	1702905.....	10	1704603.....	15	1705401.....	20	1706795.....	28
1702200.....	12	1702910.....	10	1704605.....	15	1705403.....	20	1706800.....	28
1702203.....	12	1702920.....	35	1704610.....	15	1705405.....	20	1706803.....	28
1702205.....	12	1702920TRAY.....	35	1704615.....	15	1705410.....	20	1706805.....	28
1702210.....	12	1702940.....	35	1704705.....	14	1705415.....	20	1706810.....	28
1702215.....	12	1702940TRAY.....	35	1704710.....	14	1705420.....	20	1706815.....	28
1702225.....	29	1702950.....	35	1704715.....	14	1705425.....	20	1706825.....	28
1702230.....	29	1702950TRAY.....	35	1705100.....	25	1705430.....	20	1706833.....	28
1702235.....	29	1702960.....	35	1705101.....	25	1705431.....	20	1706835.....	28
1702240.....	29	1702960TRAY.....	35	1705102.....	25	1705433.....	20	1706840.....	28
1702250.....	29	1702980.....	35	1705103.....	25	1705435.....	20	1706845.....	28
1702295.....	9	1702980TRAY.....	35	1705105.....	25	1705440.....	20	1706850.....	28
1702300.....	9	1702990.....	35	1705110.....	25	1705445.....	20	1706895.....	21
1702303.....	9	1702990TRAY.....	35	1705115.....	25	1705450.....	20	1706900.....	21
1702305.....	9	1703000.....	35	1705118.....	25	1705640.....	40	1706903.....	21
1702306.....	11	1703000TRAY.....	35	1705119.....	25	1705641.....	41	1706905.....	21
1702310.....	9	1703020.....	35	1705120.....	25	1705650.....	40	1706910.....	21
1702311.....	11	1703020TRAY.....	35	1705125.....	25	1705651.....	41	1706915.....	21

PART NO.	PAGE NO.	PART NO.	PAGE NO.	PART NO.	PAGE NO.	PART NO.	PAGE NO.	PART NO.	PAGE NO.
1706920	21	1717100	29	1729430	61	1753165	39	BP826224	45
1706925	21	1717105	29	1731020	65	1753168	39	BP826254	53
1706930	21	1717110	29	1732300	13	1754800	7	BP826524	45
1706931	21	1720305	62	1732303	13	1754803	7	BP826524B	45
1706933	21	1720308	62	1732305	13	1754805	7	BP826524P	45
1706935	21	1720315	62	1732310	13	3005833	77	BP826524W	45
1706940	21	1720318	62	1732315	13	3008086	56	BP827024	45
1706945	21	1721010	65	1732400	13	3008745	78	BP827054	53
1706950	21	1721020	65	1732403	13	3009122	57	BP855524B	45
1706960	22	1721025	65	1732405	13	3009938	57	BP855524P	45
1706963	22	1721030	65	1732500	13	3010339	78	BP855524W	45
1706965	22	1721551	37	1732503	13	3019101	77	BP855548B	53
1706970	22	1721556	37	1732505	13	3022729	78	BP855548W	53
1706975	22	1721561	37	1732510	13	3023460	78	BP855924	47
1706980	22	1721563	37	1734300	13	3026586	78	BP855924B	47
1706985	22	1721564	37	1734303	13	3028392	78	BP855924P	47
1706990	22	1721565	37	1734305	13	3028786	78	BP855924W	47
1707020	68	1721568	37	1734400	13	3029916	78	BP925824	45
1707960	22	1721768	36	1734403	13	3029917	78	BP925824B	45
1707963	22	1722010	67	1734405	13	3030481	77	BP925824P	45
1707965	22	1722305	62	1734500	13	3035896	57	BP925824W	45
1707970	22	1722551	37	1734503	13	3037014	56	BP964824	51
1707975	22	1722556	37	1734505	13	3037014A	56	BP964824B	51
1707980	22	1722561	37	1735100	27	3043331	78	BP964824BLL	51
1707985	22	1722563	37	1735103	27	3045508	78	BP964824P	51
1707990	22	1722564	37	1735105	27	3047012	79	BP964824W	51
1708310	9	1722565	37	1735130	27	3047140	78	BP964824WLL	51
1708410	10	1722568	37	1735133	27	5239012	74	BP965724	49
1709410	61	1722768	36	1735135	27	5239018	74	BP965724B	49
1709415	61	1725100	26	1739410	61	5239024	74	BP965724W	49
1709420	61	1725101	26	1739415	61	5621827	57		
1709425	61	1725102	26	1739420	61	5621928	57	C	
1709430	61	1725103	26	1739425	61	5622436	57	CDC01Z	77
1710305	62	1725105	26	1739430	61	5622537	57	D	
1710308	62	1725110	26	1751651	38	5622638	57	DM0212BF	78
1710315	62	1725115	26	1751656	38	5622739	57	DM0212BM	78
1710318	62	1725116	26	1751661	38	5623654	57	DM1212B	78
1711010	65	1725118	26	1751663	38	5623755	57	F	
1711020	65	1725119	26	1751664	38	5624872	57	FNE031018034	78
1711025	65	1725120	26	1751665	38	5624973	57	L	
1711030	65	1725125	26	1751668	38	5625074	57	L38RLSCH545	77
1711205	63	1725130	26	1752151	38	5625175	57	L3890RLS	77
1711206	63	1725133	26	1752156	38	5626090	57	L8815	76
1712010	67	1725135	26	1752161	38	5626191	57	L8815GO	76
1712020	67	1725140	26	1752163	38	5910024	75	L8816	76
1712030	67	1725145	26	1752164	38	9031100	69	L8816R	76
1712035	67	1725147	26	1752165	38	9031105	69	L8825	76
1712110	67	1725148	26	1752168	38	9031110	69	L8835	76
1712120	67	1725149	26	1752800	7	56296144	57	L8855	76
1712200	23	1725150	26	1752803	7	56297145	57	L8915	76
1712205	23	1725153	26	1752805	7	56298146	57	L882502	76
1712210	23	1725160	26	1752810	7	562109166	57	LL9000	76
1712230	68	1725640	40	1752815	7, 34	562133202	57	LL90003	76
1712240	68	1725641	41	1752825	7, 34	B			
1712250	68	1725641	41	1752825	7, 34	BP141624	55		
1712255	68	1725650	40	1752835	7, 34	BP824624	47	U	
1712260	68	1725651	41	1752836	7, 34	BP824624B	47	UB623516	56
1715100	26	1725660	40	1753151	39	BP824624B	47		
1715105	26	1729410	61	1753156	39	BP824624P	47		
1715110	26	1729415	61	1753161	39	BP824624W	47		
1715115	26	1729420	61	1753163	39	BP825524	45		
		1729425	61	1753164	39				

The Buyers family of manufacturing companies

Tracom

B **Boomerang**
RUBBER, INC.

Romotech
Rotational Molding Technologies, Inc.

P **PROGRESSIVE**
POWDER COATING, INC.



See page 73 for Wide Open Step Boxes

www.buyersproducts.com

Buyers
PRODUCTS COMPANY

SnowDogg
by Buyers

SaltDogg
by Buyers

ScoopDogg
by Buyers

DumperDogg
by Buyers