

Lifting Capacities

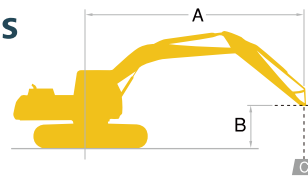

Rating over front



Rating over side or 90 degrees

A – Reach from swing centerline to arm tip
B – Arm bucket pin height above/below ground
C – Lifting capacities in pounds (kilograms)

SK260LC		Standard Arm: 9'9" (2.98m), no bucket, 2'7" (800mm) track shoes											HEAVY LIFT	
		5' (1.5m)		10' (3.0m)		15' (4.6m)		20' (6.1m)		25' (7.6m)		At Max. Reach		Radius
25' (7.6m)	lb(kg)													
20' (6.1m)	lb(kg)													
15' (4.6m)	lb(kg)													
10' (3.0m)	lb(kg)													
5' (1.5m)	lb(kg)													
Ground Level	lb(kg)													
-5' (-1.5m)	lb(kg)	*16,610(7,530)	*16,610(7,530)	*26,340(11,940)	*26,340(11,940)	*29,200(13,240)	19,880(9,010)	20,780(9,420)	13,290(6,020)	14,960(6,780)	9,800(4,440)	*12,450(5,640)	8,330(3,770)	28'2" (8.58m)
-10' (-3.0m)	lb(kg)	*29,290(13,280)	*29,290(13,280)	*40,290(18,270)	39,470(17,900)	*28,280(12,820)	19,870(9,010)	20,630(9,350)	13,150(5,960)					
-15' (-4.6m)	lb(kg)			*33,810(15,330)	*33,810(15,330)	*24,230(10,990)	20,500(9,290)							

SK260LC		Long Arm: 12'0" (3.66m), no bucket, 2'7" (800mm) track shoes											HEAVY LIFT			
		5' (1.5m)		10' (3.0m)		15' (4.6m)		20' (6.1m)		25' (7.6m)		30' (9.1m)		At Max. Reach		Radius
25' (7.6m)	lb(kg)															
20' (6.1m)	lb(kg)															
15' (4.6m)	lb(kg)															
10' (3.0m)	lb(kg)															
5' (1.5m)	lb(kg)															
Ground Level	lb(kg)															
-5' (-1.5m)	lb(kg)	*14,590(6,610)	*14,590(6,610)	*24,010(10,890)	*24,010(10,890)	*29,400(13,330)	19,810(8,980)	20,700(9,380)	13,110(5,940)	14,880(6,740)	9,650(4,370)	*10,060(4,560)	7,930(3,590)	28'11" (8.83m)		
-10' (-3.0m)	lb(kg)	*23,840(10,810)	*23,840(10,810)	*35,270(15,990)	*35,270(15,990)	*28,950(13,130)	19,820(8,990)	20,640(9,360)	13,060(5,920)	14,910(6,760)	9,680(4,390)					
-15' (-4.6m)	lb(kg)	*35,350(16,030)	*35,350(16,030)	*37,730(17,110)	*37,730(17,110)	*26,300(11,920)	20,240(9,180)	*19,380(8,790)	13,370(6,060)							
-20' (-6.1m)	lb(kg)					*19,210(8,710)	*19,210(8,710)									

Notes:

- Do not attempt to lift or hold any load that is greater than these lift capacities at their specified lift point radius and heights. Weight of all accessories must be deducted from the above lift capacities.
- Lift capacities are based on machine standing on level, firm, and uniform ground. User must make allowance for job conditions such as soft or uneven ground, out of level conditions, side loads, sudden stopping of loads, hazardous conditions, experience of personnel, etc.
- Arm bucket pin, without bucket is defined as lift point.
- The above lifting capacities are in compliance with SAE J10567. They do not exceed 87 % of hydraulic lifting capacity or 75 % of tipping load. Lifting capacities marked with an asterisk (*) are limited by hydraulic capacity rather than tipping load.
- Operator should be fully acquainted with the Operator's and Maintenance Instructions before operating this machine. Rules for safe operation of equipment should be adhered to at all times.
- Lift capacities apply to only machines as originally manufactured and normally equipped by KOBELCO CONSTRUCTION MACHINERY CO., LTD.

STANDARD EQUIPMENT

ENGINE

- Turbocharged and inter-cooled HINO J05EUN-KSSD Tier IV Final Diesel engine
- Automatic engine deceleration
- Two 12V, 112Ah batteries
- 24V, 5kW starting motor
- 60-amp alternator
- Removable radiator clean-out screen
- Automatic engine shut-down if low engine oil pressure
- Side by side oil, hydraulic and engine radiators
- Double-element air cleaner

Lower track guards

HYDRAULIC

- Exclusive boom to arm regeneration systems
- Auto warm-up system
- Hydraulic oil cooler

MIRRORS & LIGHTS

- Three rearview mirrors plus rear-view camera
- Two front working lights
- Swing flashers

CAB & CONTROL

- ROPS cab
- Two pilot-operated control levers
- Electric horn
- Integrated left-right slide-type control box
- All-weather, sound-insulated cab
- Interior cab light
- Coat hook
- Luggage tray
- Large cup holder
- Detachable two-piece floor mat
- 7-way adjustable suspension seat
- Headrest

Handrails

- Heater and defroster
- Intermittent windshield wiper with double-spray washer
- Skylight
- Top guard
- Tinted safety glass
- Pull-type front window and removable lower front window
- Easy to read multi-display monitor
- Automatic climate control
- Emergency escape hammer
- AM/FM stereo radio
- Travel alarm
- Attachment pressure release switch
- Manual DPF switch
- 12V converter
- Two-way control pattern changer

OPTIONAL EQUIPMENT

- Wide range of shoes
- Boom & arm load (lock) holding valve
- Front-guard protective structures
- Additional hydraulic circuits

Note: This document may contain attachments and optional equipment that are not available in your area. It may also contain photographs of machines with specifications that differ from those sold in your area. Please contact your nearest KOBELCO dealer for items you require.

Due to our policy of continuous product improvement, all designs and specifications are subject to change without advance notice.

Copyright © KOBELCO CONSTRUCTION MACHINERY CO., LTD. No part of this document may be reproduced in any manner without prior written permission from KOBELCO.

KOBELCO CONSTRUCTION MACHINERY U.S.A. INC.

22350 Merchants Way, Katy, Texas 77449
http://www.kobelco-usa.com/

Inquiries To:

Bulletin No. SK260LC-10-NA-101

KOBELCO

DRIVEN BY PASSION

Hydraulic Excavator

SK260 LC

SK260LC-10

Bucket Capacity :

1.05 - 1.31 cu. yd. SAE

Engine Power :

178 hp {133 kW} @ 2,100 rpm
(SAE NET)

Operating Weight :

58,900 lbs {26,700 kg}



Complies with the latest exhaust emission regulations



US EPA
Tier IV Final



EU (NRMM)
Stage IV



Japanese
Regulations

Power Meets Efficiency

Increased POWER
means increased
PRODUCTIVITY

Greater fuel
economy means
higher efficiency

From urban centers to mines around the world, KOBELCO's all-out innovation brings you durable, Earth-friendly construction machinery that's equal to any task all over the planet. Increased power and better fuel economy bring greater efficiency to any project. The KOBELCO SK260LC Conventional Hydraulic Excavator is more durable than ever, able to withstand the rigors of the toughest job sites. Focusing on the global environment of the future, KOBELCO offers next-generation productivity to meet the need for lower life-cycle costs and exceed the expectations of customers the world over. It all adds up to new levels of value that are a step ahead of the times.



SK260_{LC}



More power and higher efficiency.

The highly efficient hydraulic system minimizes fuel consumption while maximizing power. With nimble movement and outstanding digging power, this excavator improves job productivity.

↑ About 5% increase ■ Digging volume/hour
(Compared to H-mode on previous models)

Increased POWER means increased PRODUCTIVITY

Power to do more, faster

Digging Volume

The SK260LC offers dynamic digging force even as it minimizes fuel consumption, achieving class-leading work volume. H-mode is used for maximum productivity, delivering 5% greater digging volume.

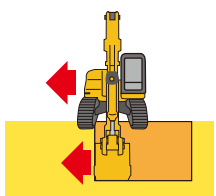
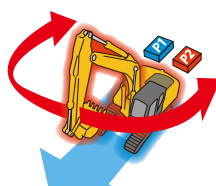
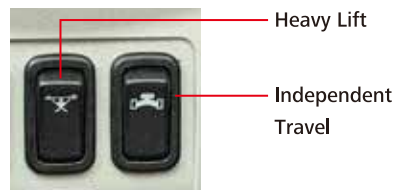

Heavy Lift

10% more hydraulic pressure (Heavy Lift) means greater lifting power, at close radius, allowing for smooth and steady operation while moving heavy objects.

Independent Travel

Selecting Independent Travel dedicates one hydraulic pump to travel and one to the attachment on a continuous basis, allowing for a smooth and constant movement speed even while swinging or using the boom or attachment. With Independent Travel, safely carrying a large pipe across a job site is a breeze.

Swing Priority

Our exclusive system automatically and instantly delivers full swing power during combined operations. There's no need to mode-switch to make quick work of jobs like side-digging and back-filling.

Power Boost

When you need more power instantly, engage Power Boost to get 10% more power.

■ Max. Bucket Digging Force
With Power Boost: **42,000lbs (187kN)**

■ Max. Arm Crowding Force
With Power Boost: **30,100lbs (134kN)**

Drawbar Pulling Force

Excellent drawbar force lets you conquer rough terrain and slopes.

55,100lbs (245kN)

Conforms to Tier IV Final exhaust emissions standards

Reduces fuel consumption and minimizes exhaust emissions

Hino engines are renowned for fuel efficiency and environmental performance, and KOBELCO has tuned them specifically for construction machinery. The high-pressure common rail fuel injection system, the variable-geometry (VG) turbocharger, and the exhaust gas recirculation (EGR) system reduce particulate matter (PM) while the large EGR cooler greatly reduces the formation of Nitrogen Oxide (NOx) gases.



VG turbo reduces PM

The variable-geometry turbocharger adjusts air intake to maximize combustion efficiency. At low engine speeds the nozzles are closed, the turbo speed increased and air intake is boosted. This helps lower fuel consumption.

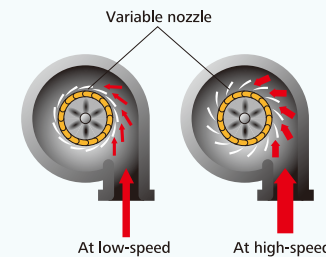

SCR System with DEF **NEW**

Engine exhaust system utilizes Selective Catalytic Reduction (SCR) to convert NOx* into harmless nitrogen and water emissions. SCR combined with a Diesel Particulate Filter (DPF) makes the SK260LC a much cleaner machine meeting US EPA regulations for Tier IV final.

■ NOx reduction rate
(Compared to previous models)

About **80% decrease***
*80% cleaner than Tier IV Interim

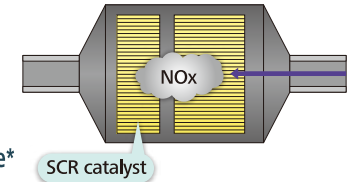

EGR cooler reduces NOx

Cooled exhaust gases from the EGR cooler are mixed with fresh air in the intake. The recirculated air lowers the combustion temperature which reduces NOx.

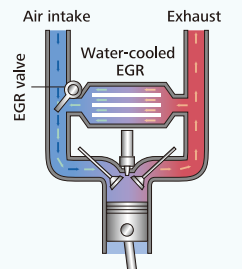

Revolutionary technology boosts efficiency and minimizes fuel consumption

Operation Mode

Improved fuel economy in ECO- and S-modes.

■ Compared to previous models

E ECO-mode ... About **9%** improvement

S S-mode ... About **10%** improvement

Greater fuel economy means higher efficiency

Always and Forever. Yesterday, Today, and Tomorrow. We're Obsessed with Fuel Efficiency.

Over the past 10 years, KOBELCO has achieved an average fuel consumption reduction of 36% across its fleet. We vow to lead the industry in improving fuel efficiency.

■ Compared to SK260LC-6 model (2006)

E ECO-mode (SK260LC-10) ... About **36%** improvement

Boom to Arm Regeneration System **NEW**

Innovative engineering uses the downward movement of the boom to push fluid to the arm. Gravity and kinetic energy greatly reduce the amount of power needed to move fluid through the system.

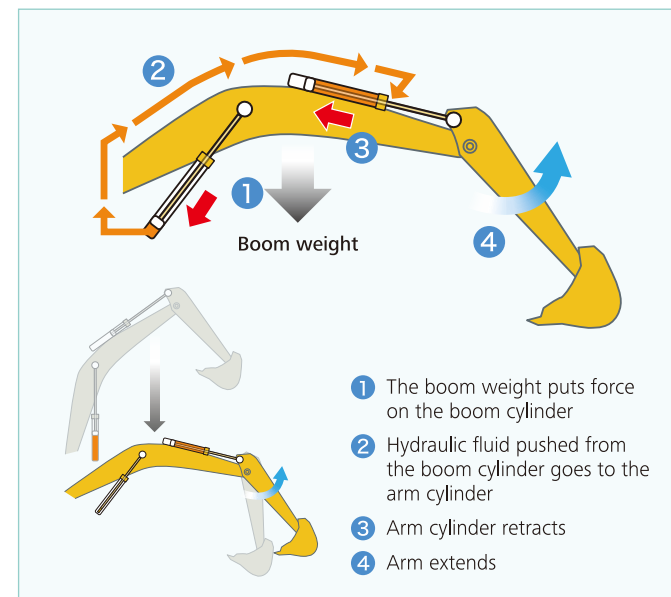

Hydraulic circuit reduces energy loss

Improved hydraulic line layout minimizes hydraulic pressure resistance from turbulence and valve restrictions. Fuel efficiency is increased because it takes less energy to move fluid through a circuit with low flow resistance.

Improved hydraulic piping is an effective means of reducing pressure loss.

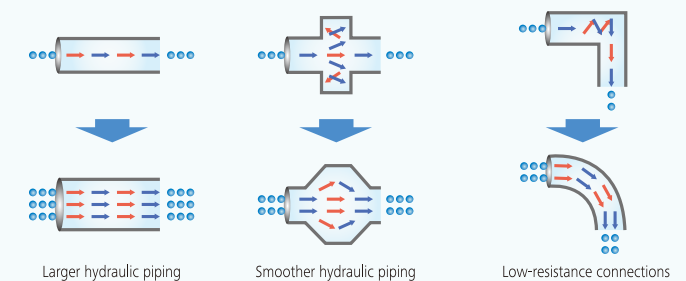

AIS (Auto Idle Stop)

The engine will stop automatically after 60 seconds of inactivity if the safety lock lever is in the up position. This eliminates wasteful idling during standby, saving fuel and reducing CO₂ emissions.

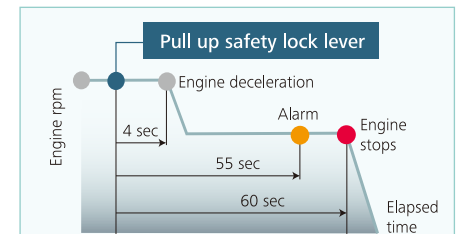

Increased power with enhanced durability to maintain the machine's value

Smart system design increases strength and eliminates hydraulic problems. Enhanced reliability and durability takes productivity to a new level.



Built to operate in tough working environments

Reinforced and redesigned boom and arm offers excellent durability during demanding work conditions to reliably handle higher work volume.

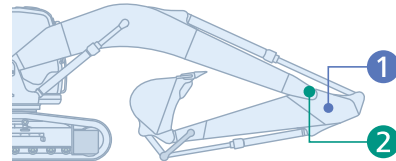

1 Enlarged reinforcement of the arm

Arm: Base plate thickness has been increased.

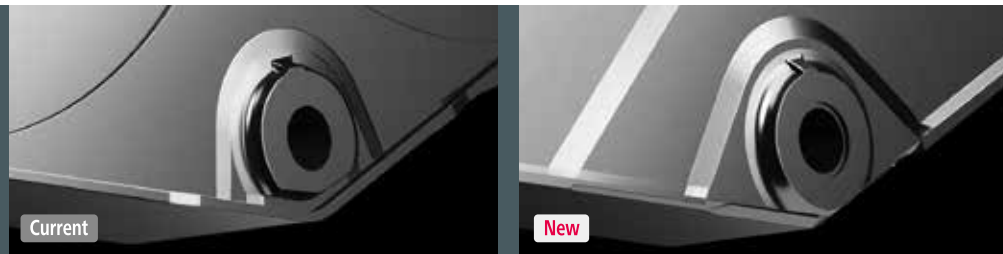

2 Modified foot boss shape

Arm foot boss shape has been changed to better distribute stress.



500 Hour Attachment Lubrication Interval

The self lubrication bushings are used at the attachment pins and the bushings with high abrasion resistant property are used at the pins around the bucket. The lubrication cycle of the lubrication points around the bucket is 250 hours and that of other lubrication points is 500 hours.



* Additionally the two piece bucket bushings protect the side of the arm from contact and then wear from the bucket ears. Should the bucket bushings need replacement, they can be replaced separately from the larger main bushing, reducing costs.

Three Track Guides

Three heavy-duty track guides installed on each crawler side frame assure stability in the most demanding situations.



Improved filtration system reliability

Clean, contaminant-free fuel and hydraulic fluid are essential to stable performance. The improved filtration systems reduce the risk of mechanical trouble and enhance longevity and durability.

Hydraulic fluid filter

Recognized as the best in the industry, our super-fine filter separates out even the smallest particles. A new cover prevents contamination when changing filters.

Long-life hydraulic fluid:
5,000 hours

Hydraulic fluid filter replacement cycle is
1,000 hours



Hydraulic fluid filter restriction indicator

Detects clogging by measuring the difference in pressure between incoming and outgoing hydraulic fluid. Detecting contaminants before they can get into the hydraulic fluid reservoir reduces the risk of damage to the hydraulic system.

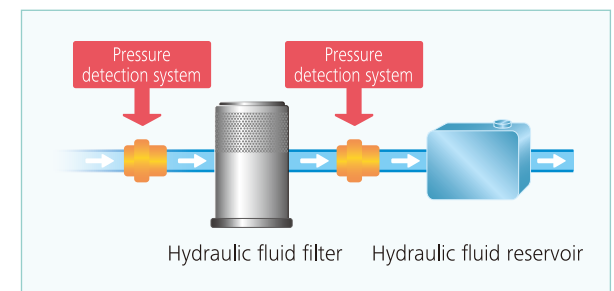

Double-element air cleaner

The large-capacity element features a double-filter structure that keeps the engine running clean even in industrial environments.



Fuel filter

Pre-filter with built-in water-separator maximizes filtering performance.

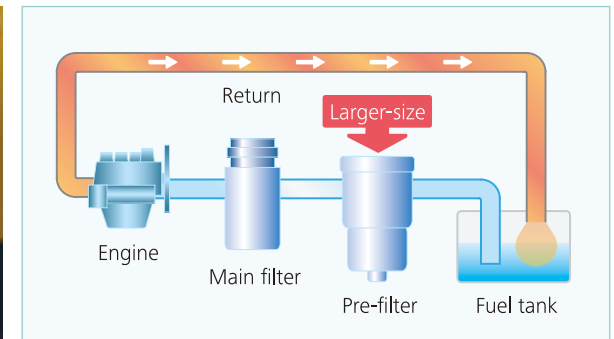

Comprehensive safety and intuitive operation

User-friendly design and enhanced safety means greater efficiency and productivity.



Safety

ROPS Cab

ROPS (Roll-Over-Protective Structure)-compliant cab complies with ISO standards (ISO-12117-2: 2008) and ensures greater operator safety in the event of a roll-over. KOBELCO encourages operators to wear their seat belt during operation.



• Top Guard Level II (Meets ISO10262)



* Mounting brackets for vandalism guards are standard equipment (contact your KOBELCO dealer to fit vandalism or front rock guards).

Expanded field of view for greater safety



Left and right rear-view mirrors/Right bottom clearance mirror



Rear view from cab

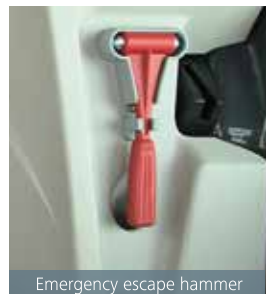

Emergency escape hammer

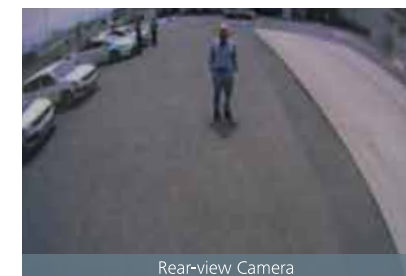

Rear-view Camera



Standard rear-view camera eases safety checks behind the machine. Color video displays on cab monitor.



Standard rear swing flashers and rear work lights.

Operator-friendly features that are easy to see, easy to use



Color Multi-display

Brilliant colors differentiate multiple graphics on cab LCD. Graphics indicate fuel consumption, maintenance intervals and more.

- 1 Analog-style gauges provide an intuitive reading of fuel level and engine temperature
- 2 Green indicates ECO mode selected or efficient operation in other modes
- 3 PM accumulation (left)/DEF level (right)
- 4 Fuel consumption/Rear-view camera
- 5 Digging mode switch
- 6 Monitor display switch

One-touch attachment mode switch

A simple flick of switch converts the hydraulic circuit and flow amount to match attachments. Helpful icons let the operator confirm the proper configuration at a glance.



PM accumulation/DEF level



Fuel consumption



Maintenance



Breaker mode



Nibbler mode



Independent Travel mode



Heavy Lift



Rear-view camera

Cab comfort takes a step ahead

The newly refined cab puts the operator first, ensuring a quieter, more comfortable work environment and easier operation.



Comfort

Climate control outlets behind the seat **NEW**



Five air outlets deliver warm or cool air directly to the operator.

A light touch on the lever means smoother, **NEW** less tiring work



It takes 25% less effort to work the operation lever, which reduces fatigue over long working hours or continuous operations.

More comfortable seat means higher productivity



Suspension seat absorbs vibration



Seat back can be lowered flat



Double slides allow adjustment for optimum comfort

Quiet Inside



The high level of air-tightness ensures a quiet, comfortable cabin interior.

Interior equipment adds to comfort and convenience



AM/FM stereo radio



USB connector/12V power outlet

Large door allows easy access in and out of the cab

The expanded cab provides plenty of room for a large door, more headroom and smoother entry and exit.



Low Vibration

Coil springs absorb small vibrations and high suspension mounts filled with silicone oil reduce heavy vibration. The long stroke achieved by this system provides excellent vibration protection.

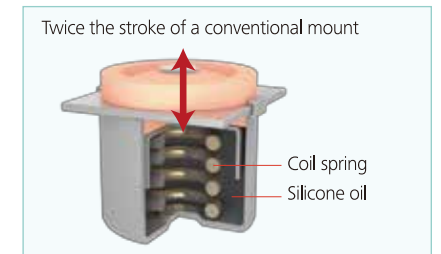

Wide, Open View Liberates the Operator

The front window features one large piece of glass without a center pillar on the right side for a wide, unobstructed view.

Efficient maintenance keeps the machine in peak operating condition



MAINTENANCE			
	INTERVAL	REMAINING TIME	EXCHANGE DAY
ENGINE OIL	500	495	--/--/--
FUEL FILTER	500	495	--/--/--
HYD. FILTER	1000	995	--/--/--
HYD. OIL	5000	4995	--/--/--

Examples of displaying maintenance information

Machine information display function

- Displays only the maintenance information that's needed, when it's needed
- Self-diagnostic function provides early-warning detection and display of electrical system malfunctions
- Service-diagnostic function makes it easier to check the status of the machine
- Record function for any possible on going or intermittent service issues

Easy, on-the-spot maintenance NEW

Ample space in the engine compartment allows service staff to comfortably perform maintenance in a natural body position. The distance between access steps is smaller so getting to and from the engine compartment is easier. The hood is lighter and easier to raise and lower.



Generous space for maintenance work



Step/storage box/DEF fill location



DEF/AdBlue tank



Double-element air cleaner

The DEF fill is located inside the convenient storage compartment.

Ground-level Access

Design allows for easy access at ground level for daily checks and maintenance work.



Fuel filter/Fuel filter with integrated water separator



Engine oil filter



Left side (radiator and cooling system)

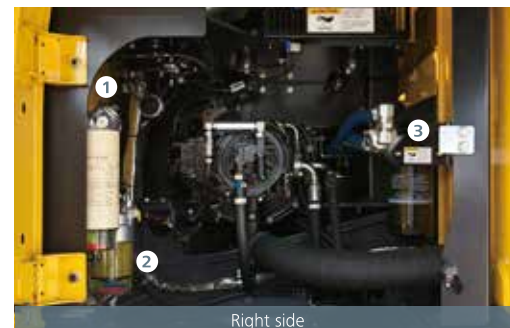

Right side

Laid out for easy access to radiator and cooling system elements

- 1 Fuel filter
- 2 Fuel filter with integrated water separator
- 3 Engine oil filter

Easy Access to In-cab Maintenance Features



Easy Cleaning



Fuel tank drain valve.

Total Support for Machines with Network Speed and Accuracy

KOMEXS is a satellite-based system for receiving machine information. Manage your machines anywhere in the world using the Internet. Location, workload and diagnostic data aid business operations.

Direct Access to Operational Status

Location Data

Accurate location data can be obtained even from sites where communications are difficult.

Operating Hours

A comparison of operating times of machines at multiple locations shows which locations are busier and more profitable. Operating hours on site can be accurately recorded, for running time calculations needed for rental machines, etc.

Fuel Consumption Data

Data on fuel consumption and idling times can be used to indicate improvements in fuel consumption.

Graph of Work Content

The graph shows how working hours are divided among different operating categories, including digging, idling, traveling, and optional operations (NGB).



Maintenance Data and Warning Alerts

Machine Maintenance Data

Provides maintenance status of separate machines operating at multiple sites. Maintenance data is also relayed to KOBELCO service personnel, for more efficient planning of periodic servicing.

Security System

Engine Start Alarm

Sends a notification if the engine is started outside of pre-defined hours.

Area Alarm

Sends a notification if the machine leaves a pre-defined area.

Engine

Model	HINO JOSEUN-KSSD
Type	Direct injection, water-cooled, 4-cycle diesel engine with turbocharger, intercooler (Complies with EU (NRMM) Stage IV, EPA Tier IV Final.
No. of cylinders	4
Bore and stroke	4.41" (112 mm) x 5.12" (130 mm)
Displacement	312.6 cu. in (5.123L)
Rated power output	178hp {133kW} /2,100rpm (SAE NET) 185hp {138kW} /2,100rpm (Without fan)
Max. torque	469lb-ft {636N.m} /1,600rpm (SAE NET) 487lb-ft {660N.m} /1,600rpm (Without fan)

Hydraulic System

Pump	
Type	Two variable displacement pumps + 1 gear pump
Max. discharge flow	2 x 64.7 U.S.gph {2 x 245 L/min}, 1 x 5.5 U.S.gph {1 x 21 L/min}
Relief valve setting	
Boom, arm and bucket	4,970 psi {34.3 Mpa}
Power Boost	5,480 psi {37.8 Mpa}
Travel circuit	4,970 psi {34.3 Mpa}
Swing circuit	4,210 psi {28.4 Mpa}
Control circuit	725 psi {5.0 Mpa}
Pilot control pump	Gear type
Main control valves	8-spool
Oil cooler	Air cooled type

Swing System

Swing motor	Axial piston motor
Parking brake	Oil disc brake, hydraulic operated automatically
Swing speed	10.2 rpm
Swing torque	63,300 lb.ft {85.9 kN.m} (SAE)
Tail swing radius	10'2" {3,100 mm}
Min. front swing radius	12'10" {3,910 mm}

Bucket Selection Chart

Bucket type	Capacity (SAE) Cubic Yard (m³)	Width Inches (m)	Bucket Weight lb (kg)	Arm ft-in (m)	
				9'9" (2.98)	12'0" (3.66)
General	.875 (.669)	24" (.609)	1,560 (708)	H	H
	1.125 (.860)	30" (.762)	1,710 (776)	H	H
	1.375 (1.051)	36" (.914)	1,860 (844)	H	M
	1.625 (1.243)	42" (1.066)	2,060 (934)	M	L
	1.71 (1.31)	48" (1.219)	2,539 (1,176)	M	X
	2.0 (1.53)	54" (1.371)	3,065 (1,390)	L	X
Heavy Duty	.875 (.669)	30" (.762)	1,840 (834)	H	H
	1.125 (.860)	36" (.914)	2,000 (907)	H	M
	1.375 (1.051)	42" (1.066)	2,215 (1,004)	M	L
	1.625 (1.242)	48" (1.219)	2,335 (1,059)	L	X
Severe Duty	.75 (.573)	27" (.685)	2,205 (1,000)	H	M
	1.00 (.764)	30" (.762)	2,450 (1,111)	M	X
	1.125 (.860)	36" (.914)	2,545 (1,154)	X	X

H - Used with material weight up to 3,000 lbs/cu yd (1,780 kg/m³) M - Used with material weight up to 2,500 lbs/cu yd (1,483 kg/m³)
L - Used with material weight up to 2,000 lbs/cu yd (1,186 kg/m³) X - Not recommended

Travel System

Travel motors	2 x axial piston, two-speed motors
Parking brakes	Oil disc brake per motor
Travel shoes	51 each side
Travel speed	3.7 / 2.2 mph {5.8 / 3.6 km/h}
Drawbar pulling force	55,100 lbs {245 kN} (SAE J 1309)
Gradeability	70 % {35°}
Ground clearance	1'6" (460 mm)

Cab & Control

Cab	
All-weather, sound-suppressed steel cab mounted on the silicon-sealed suspension mounts and equipped with a heavy, insulated floor mat.	
Control	
Two hand levers and two foot pedals for travel	
Two hand levers for excavating and swing	
Electric rotary-type engine throttle	

Boom, Arm & Bucket

Boom cylinder	5.3" {135 mm} x 4'1" {1,235 mm}
Arm cylinder	5.7" {145 mm} x 5'4" {1,635 mm}
Bucket cylinder	4.9" {125 mm} x 3'11" {1,200 mm}

Refilling Capacities & Lubrications

Fuel tank	106.5 U.S.gal {403L}
Cooling system	5.5 U.S.gal {21L}
Engine oil	5.4 U.S.gal {20.5L}
Travel reduction gear	2 x 1.3 U.S.gal {2 x 5.0 L}
Swing reduction gear	1.3 U.S.gal {5.0 L}
Hydraulic oil tank	43.6 U.S.gal {165 L} tank oil level
	72.1 U.S.gal {273 L} hydraulic system
DEF/AdBlue tank	21.9 U.S.gal {83L}

Working Ranges

Unit: ft-in(m)

Range	Arm	19'9" (6.02 m)	
		Standard 9'9" (2.98 m)	Long 12'0" (3.66 m)
a- Max. digging reach		33'10" {10.30}	36'0" {10.98}
b- Max. digging reach at ground level		33'3" {10.14}	35'6" {10.82}
c- Max. digging depth		23'0" {7.00}	25'2" {7.68}
d- Max. digging height		32'1" {9.79}	33'6" {10.22}
e- Max. dumping clearance		22'7" {6.88}	23'11" {7.28}
f - Min. dumping clearance		8'4" {2.55}	6'2" {1.87}
g- Max. vertical wall digging depth		20'2" {6.15}	22'10" {6.97}
h- Min. swing radius		12'10" {3.91}	12'10" {3.92}
i - Horizontal digging stroke at ground level		17'3" {5.26}	21'3" {6.48}
j - Digging depth for 8 feet flat bottom		22'5" {6.82}	24'9" {7.54}
Bucket capacity SAE heaped cu.yd.{m³}		1.31 {1.00}	1.05 {0.80}

Digging Force

Unit: lbs (kN)

Arm length		Standard 9'9" (2.98 m)	Long 12'0" (3.66 m)
		Bucket digging force	SAE 35,000 {156} 38,500 {171}* ISO 38,200 {170} 42,000 {187}*
Arm crowding force	SAE	26,100 {116} 28,600 {127}*	22,700 {101}
	ISO	27,400 {122} 30,100 {134}*	23,400 {104}

*Power Boost engaged.

Dimensions

Arm length	Standard 9'9" (2.98 m)	Long 12'0" (3.66 m)
A Overall length	33'6" {10,210}	33'7" {10,230}
B Overall height (to top of boom)	10'5" {3,180}	10'10" {3,300}
C Overall width	11'1" {3,390}**	
D Overall height (to top of cab)	10'2" {3,090}	
E Ground clearance of rear end*	3'7" {1,090}	
F Ground clearance*	1'6" {460}	

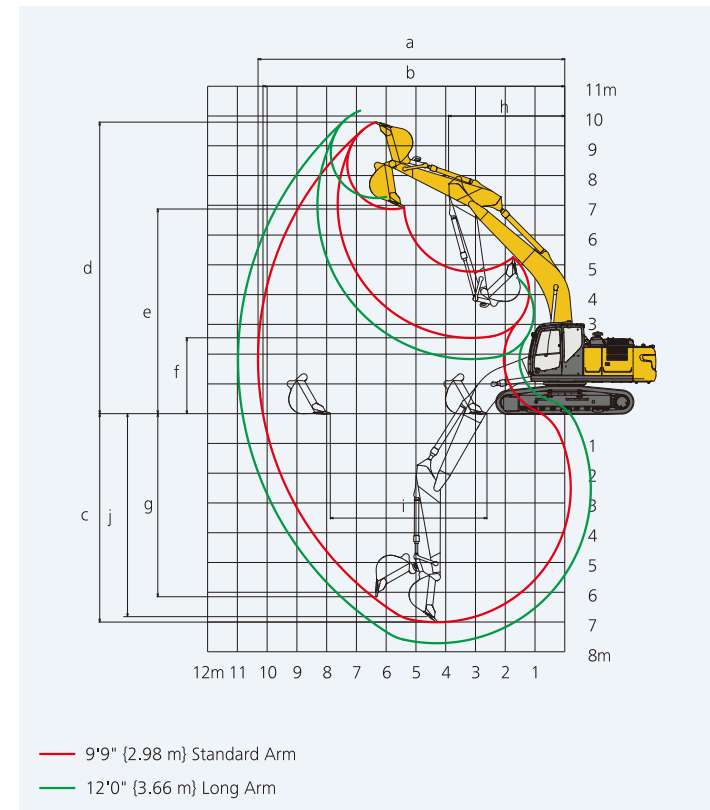

Unit: ft-in (mm)

G Tail swing radius	10'2" {3,100}
G' Distance from center of swing to rear end	10'11" {3,070}
H Tumbler distance	12'8" {3,850}
I Overall length of crawler	15'3" {4,640}
J Track gauge	8'6" {2,590}
K Shoe Width. In(mm)	24" (600)/28"(700)/31.5"(800)
L Overall width of upperstructure	10'3" {3,120}

* Without including height of shoe lug
** Shoe width : 2'7" {800mm}

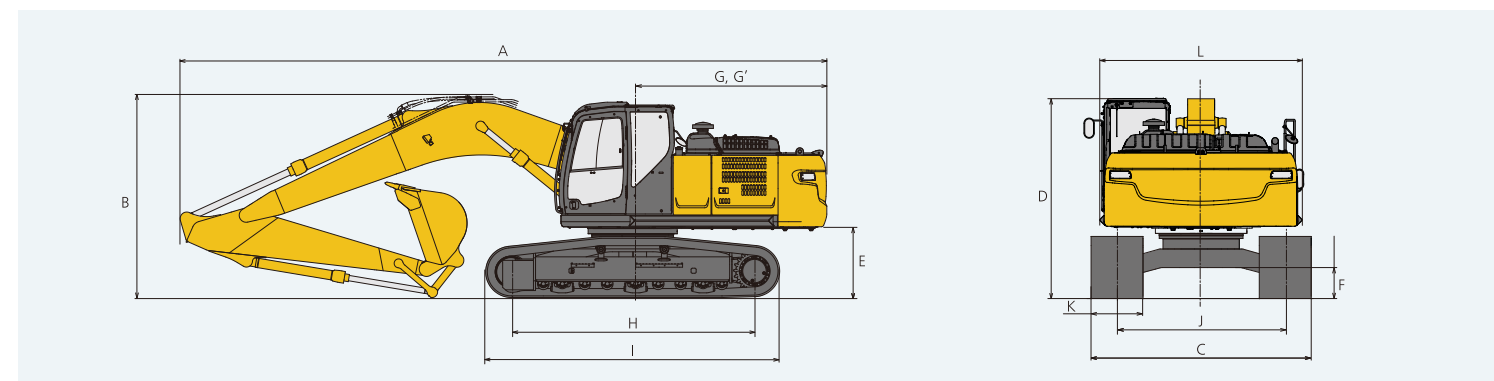

Operating Weight & Ground Pressure

In standard trim, with standard boom, 9'9" {2.89m} arm, and 1.31 cu.yd. {1.00 m³} SAE heaped bucket

Shaped		Triple grouser shoes (even height)			
Shoe width	In(mm)	24" (600)	28"(700)	31.5"(800)	35"(900)
Ground pressure	psi (kPa)	7.5 {52}	6.6 {45}	5.8 {40}	5.2 {36}
Operating weight	lbs (kg)	57,900 {26,300}	58,900 {26,700}	59,300 {26,900}	60,100 {27,200}